



US Catalog

# Motor protection and control AF Range contactors & overload relays

Power and productivity  
for a better world™



# Motor rated operational powers and currents

The currents given below concern standard three-phase four-pole cage motors (1500 r.p.m. at 50 Hz 1800 r.p.m. at 60 Hz). These values are given for guidance and may vary according to the motor manufacturer and depending on the number of poles.

IEC Motor power kW	Motor nominal current: <b>standardized values in blue colour</b> (according to IEC 60947-4-1 Annex G)									
	220 V A	230 V A	240 V A	380 V A	400 V A	415 V A	440 V A	500 V A	660 V A	690 V A
0.06	0.37	0.35	0.34	0.21	0.2	0.19	0.18	0.16	0.13	0.12
0.09	0.54	0.52	0.50	0.32	0.3	0.29	0.26	0.24	0.18	0.17
0.12	0.73	0.7	0.67	0.46	0.44	0.42	0.39	0.32	0.24	0.23
0.18	1	1	1	0.63	0.6	0.58	0.53	0.48	0.37	0.35
0.25	1.6	1.5	1.4	0.9	0.85	0.82	0.74	0.68	0.51	0.49
0.37	2.0	1.9	1.8	1.2	1.1	1.1	1	0.88	0.67	0.64
0.55	2.7	2.6	2.5	1.6	1.5	1.4	1.3	1.2	0.91	0.87
0.75	3.5	3.3	3.2	2.0	1.9	1.8	1.7	1.5	1.15	1.1
1.1	4.9	4.7	4.5	2.8	2.7	2.6	2.4	2.2	1.7	1.6
1.5	6.6	6.3	6	3.8	3.6	3.5	3.2	2.9	2.2	2.1
2.2	8.9	8.5	8.1	5.2	4.9	4.7	4.3	3.9	2.9	2.8
3	11.8	11.3	10.8	6.8	6.5	6.3	5.7	5.2	4	3.8
4	15.7	15	14.4	8.9	8.5	8.2	7.4	6.8	5.1	4.9
5.5	20.9	20	19.2	12.1	11.5	11.1	10.1	9.2	7	6.7
7.5	28.2	27	25.9	16.3	15.5	14.9	13.6	12.4	9.3	8.9
11	39.7	38	36.4	23.2	22	21.2	19.3	17.6	13.4	12.8
15	53.3	51	48.9	30.5	29	28	25.4	23	17.8	17
18.5	63.8	61	58.5	36.8	35	33.7	30.7	28	22	21
22	75.3	72	69	43.2	41	39.5	35.9	33	25.1	24
30	100	96	92	57.9	55	53	48.2	44	33.5	32
37	120	115	110	69	66	64	58	53	40.8	39
45	146	140	134	84	80	77	70	64	49.1	47
55	177	169	162	102	97	93	85	78	59.6	57
75	240	230	220	139	132	127	116	106	81	77
90	291	278	266	168	160	154	140	128	97	93
110	355	340	326	205	195	188	171	156	118	113
132	418	400	383	242	230	222	202	184	140	134
160	509	487	467	295	280	270	245	224	169	162
200	637	609	584	368	350	337	307	280	212	203
250	782	748	717	453	430	414	377	344	261	250
315	983	940	901	568	540	520	473	432	327	313
355	1109	1061	1017	642	610	588	535	488	370	354
400	1255	1200	1150	726	690	665	605	552	418	400
500	1545	1478	1416	895	850	819	745	680	515	493
560	1727	1652	1583	1000	950	916	832	760	576	551
630	1928	1844	1767	1116	1060	1022	929	848	643	615
710	2164	2070	1984	1253	1190	1147	1043	952	721	690
800	2446	2340	2243	1417	1346	1297	1179	1076	815	780
900	2760	2640	2530	1598	1518	1463	1330	1214	920	880
1000	3042	2910	2789	1761	1673	1613	1466	1339	1014	970

UL/CSA Motor power hp	Motor nominal current: <b>single and three phase</b> (according to UL 60947-4-1A)									
	120 V 1-ph A	200 V 1-ph A	200 V 3-ph A	208 V 1-ph A	208 V 3-ph A	220- 240 V 1-ph A	220- 240 V 3-ph A	380- 415 V 3-ph A	440- 480 V 3-ph A	550- 600 V 3-ph A
1/10	3	-	-	-	-	1.5	-	-	-	-
1/8	3.8	-	-	-	-	1.9	-	-	-	-
1/6	4.4	2.5	-	2.4	-	2.2	-	-	-	-
1/4	5.8	3.3	-	3.2	-	2.9	-	-	-	-
1/3	7.2	4.1	-	4	-	3.6	-	-	-	-
1/2	9.8	5.6	2.5	5.4	2.4	4.9	2.2	1.3	1.1	0.9
3/4	13.8	7.9	3.7	7.6	3.5	6.9	3.2	1.8	1.6	1.3
1	16	9.2	4.8	8.8	4.6	8	4.2	2.3	2.1	1.7
1-1/2	20	11.5	6.9	11	6.6	10	6	3.3	3	2.4
2	24	13.8	7.8	13.2	7.5	12	6.8	4.3	3.4	2.7
3	34	19.6	11	18.7	10.6	17	9.6	6.1	4.8	3.9
5	56	32.2	17.5	30.8	16.7	28	15.2	9.7	7.6	6.1
7-1/2	80	46	25.3	44	24.2	40	22	14	11	9
10	100	57.5	32.2	55	30.8	50	28	18	14	11
15	135	-	48.3	-	46.2	68	42	27	21	17
20	-	-	62.1	-	59.4	88	54	34	27	22
25	-	-	78.2	-	74.8	110	68	44	34	27
30	-	-	92	-	88	136	80	51	40	32
40	-	-	120	-	114	176	104	66	52	41
50	-	-	150	-	143	216	130	83	65	52
60	-	-	177	-	169	-	154	103	77	62
75	-	-	221	-	211	-	192	128	96	77
100	-	-	285	-	273	-	248	165	124	99
125	-	-	359	-	343	-	312	208	156	125
150	-	-	414	-	396	-	360	240	180	144
200	-	-	552	-	528	-	480	320	240	192
250	-	-	-	-	-	-	604	403	302	242
300	-	-	-	-	-	-	722	482	361	289
350	-	-	-	-	-	-	828	560	414	336
400	-	-	-	-	-	-	954	636	477	382
450	-	-	-	-	-	-	1030	-	515	412
500	-	-	-	-	-	-	1180	786	590	472

# Motor protection and control

## AF Range contactors and overload relays

[Overview](#)

---

1

[AF Range contactors and control relays](#)

---

2

[Overload relays](#)

---

3

[General technical data](#)

---

4

[Catalog number alphanumeric](#)

---

5

# ABB sets a new standard in motor control and power switching

1

Featuring AF technology as standard, the latest range of ABB's contactors establishes a new industry benchmark. The electronically controlled coil offers multiple benefits over conventional alternatives, and together with ABB's wide product offering – an optimal configuration, every time.



## Access Global Support

The contactor and motor protection range from ABB is compatible with all major national and international standards and is available worldwide via a global distribution network. One contactor coil now handles 100 V – 250 V, AC/DC for use in Europe or Asia as well as North America.



## Optimize logistics

With its contactor and motor protection range, ABB has managed to reduce the number of contactor coils to just four. The total number of product variants has been reduced by up to 90%. This simplifies the customers' logistics and cuts administration costs.



## Simplify design

By reducing contactor coil energy consumption by up to 80%, panels can be built smaller and transformers more compact. All the features of the AF technology, along with access to drawings and coordination tables online, simplifies your design and assembly process.



## Secure uptime

Time to prevent stoppages caused by voltage fluctuations. The AF contactor ensures distinct operation in unstable networks and signifies a major advance in motor control and power switching. Voltage sags, dips and surges pose no threat. The AF contactor secures your uptime.



# MacGregor. Keeping turnarounds brief.

Until the AF range was installed, voltage sags were affecting MacGregor's deck cranes. Conventional contactors welded shut, leading to several stoppages a week. No longer. Known for superior quality and an ability to operate in the most hostile environments, MacGregor deck cranes enjoy a global reputation for reliability. A small but vital component, the AF contactor helps maintain this reputation.

To keep things moving, you need Control. Connect to Control.

Explore all our case studies at [www.abb.com/connecttocontrol](http://www.abb.com/connecttocontrol)

**SSAB**  
Making certainty  
standard

**Gamesa**  
Taming the wind

**LKAB**  
Providing fresh air

# Contactors and motor protection

## For a wide variety of segments

1

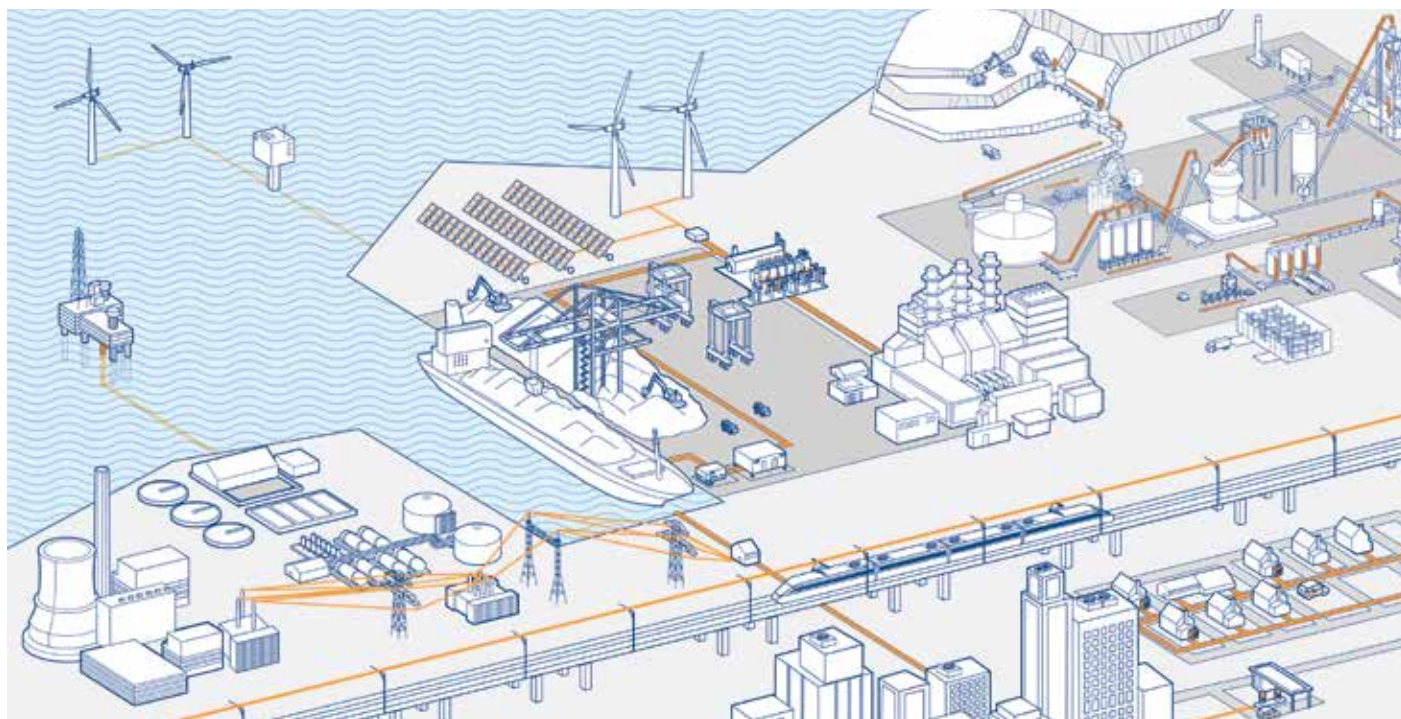

HVAC, General Machinery, Rail, Critical Power, Wind, Solar, Marine and Water & Wastewater

### Contactors for any use

The AF contactor range covers small motor starting solutions from 4 kW / 5 hp up to big power switching solutions with our unique AF2650, the biggest single case block contactor in the world.

The contactor and motor protection range is part of one of the widest product offerings on the market meaning that ABB not only can provide the contactor but the full solution.

In addition to the standard product range ABB also offer products for special needs such as Bar contactors, GAF and contactors for capacitor switching.

### Cooperating with customers

ABB cooperates closely with its customers to ensure that products meet requirements from their specific segments and applications. With over 100 years' experience in motor control and power switching ABB knows how to create efficient solutions for its customers.

# AF technology

## Benefits



### Reliable in all networks

The electronic system within the AF contactor rectifies the AC or DC control circuit voltage to a DC control voltage that is applied on the coil. The contactor is safely operated in an always optimized condition making it virtually noise free.

### Four coils for the entire voltage range

The AF contactor features both AC and DC support. With the complete AF contactor range, functionality is improved. Still, the total number of product variants compared to a conventional range is reduced by 90%. Only four coils are required to cover 24 V AC, 20 V DC - 500 V AC/DC.

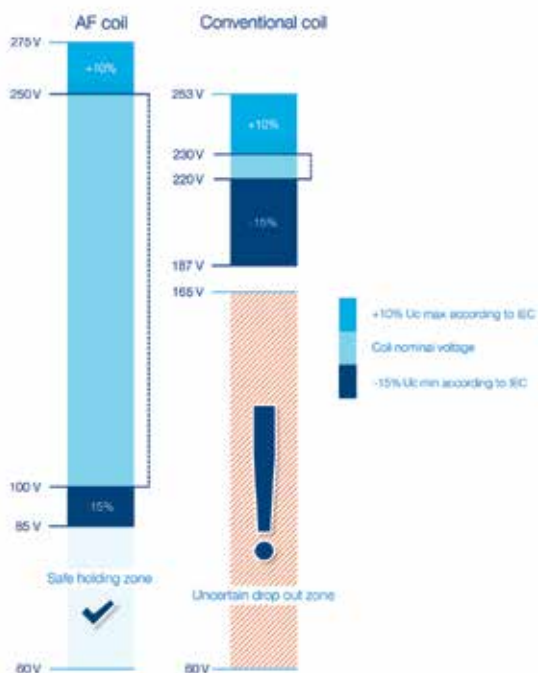

### Wide control voltage range

With conventional contactor technology, different contactors were needed for different network voltages. Thanks to the wide operating range of the AF contactor it can operate just as well in Europe as in Asia or North America. The core coil of the AF contactor range covers 100-250 V AC/DC 50/60 Hz.

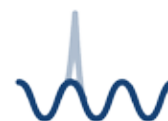

### Built-in surge suppression

With conventional contactor technology it is recommended to use an external surge suppressor, an accessory that could cost as much as half the contactor itself. With the AF technology the surges are handled by the contactor itself and the surge never reaches the control circuit. Neither the surge suppressor nor the actual surge has to be considered anymore. One less product and one less complication to worry about.

# Contactors and motor protection

## Advanced but simple

1

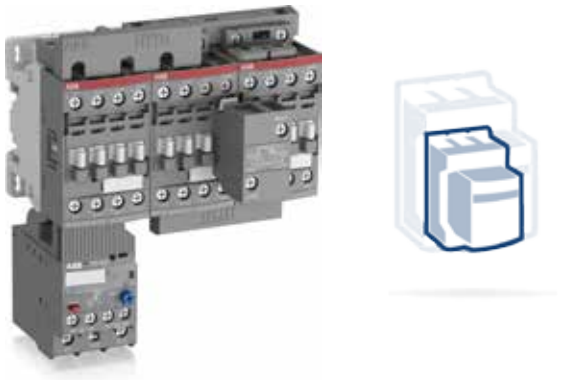

### The AF contactor is compact

The AF contactor is compact in size and has had its width reduced by up to 30% thanks to an 80% reduction of the coil's energy consumption.



### The AF contactor is flexible

AF09...AF370 is perfect for motor starting applications and for solutions where space is limited. Interlocked reversing pairs require no spacing between contactors meaning you can fit more functionality into cabinets or other small enclosures.



### Coil terminal access in the front

The AF contactor has its coil terminals accessible from the front. The cables or bars do not have to be disconnected in order to perform voltage measurement or servicing work.



### More functionality without adding width

The AF116 ... AF2650 can take up to 2 side mounted auxiliary contact blocks without adding to its width and are delivered with 1 N.O. + 1 N.C. as standard.



# Contactors and motor protection

## Mechanical features

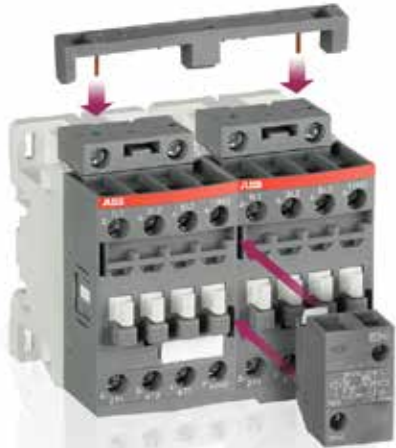

Front-mounted

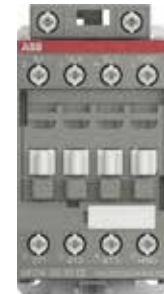

Top-mounted



Bottom-mounted



Additional LDC4 coil terminal block

### Easy-to-use accessories

Contactors up to 96 A offer free choice of coil terminal access and can take side and front mounted auxiliary contact blocks. All the accessories: Coil connection terminals, mechanical and electrical interlocks and electronic timers are easily connected through the snap-to-connect function.



### Safe control circuit with:

- Mirror contact according to IEC 60947-4-1
- Mechanically linked contacts according to IEC 60947-5-1
- Sealable and transparent protective covers on AF09...AF96 and overload relays TF/EF
- Third party certification:
  - AF09...AF96, NF
  - AF400...AF2050





## Connect to Control

ABB is introducing its complete AF contactor range. The AF technology is well appreciated by customers and establishes a new industry benchmark. ABB sets a new standard in motor control and power switching. Watch the video above or read how our customers experience the AF technology.



### Case studies

Instead of telling our customers about the AF contactor – we asked them. They are the ones using the products everyday and therefore they should have the most interesting stories.

→ Read more



### Value propositions

Choose AF contactors and ABB to secure uptime, simplify design, optimize logistics and gain access to global support. Watch videos and read why AF contactors are the right choice.

→ Read more



### Product tour

Read more about the technical details of the AF contactor and the technology. What has made it so appreciated by customers?

→ Read more

#### Sitemap

- Connect to Control
- Case studies
- Value propositions
- Product tour
- History
- News

#### Contact us

Sales → Low Voltage Products and Systems

#### Downloads

- Product panoramas (1 mb)
- Promotion video (360p, 15 mb)
- Promotion video (720p, 25 mb)
- Promotion video (1080p, 104 mb)
- Main catalog (54 mb)
- Short-form catalog (50 mb)

#### Follow us



#### Links

- Low Voltage Products
- SOC II
- Cadexes

#### Share this

- Open Facebook share
- Open Tweet box

## Videos, prints, technical presentations and more



Videos



Success stories



Global main catalog : 1SBC100173C0201  
 Global short form catalog : 1SBC100180C0201  
 Global panorama : 1SBC100176L0203

For direct product details information,  
 use product type or order code, ex:

- [www.abb.com/productdetails/AF09-30-10-13](http://www.abb.com/productdetails/AF09-30-10-13) or
- [www.abb.com/productdetails/1SBL137001R1310](http://www.abb.com/productdetails/1SBL137001R1310)



## New

### The AF range in your pocket

The eBinder gives you all the information you need about the AF range.



Always updated  
 Always available  
 Stay connected!

## Tools



Cadenas portal: Download 2D or 3D files according to your needs (STEP, IGES...)

Coordination tables for motor protection

Motor Protection Device	Rated Voltage	Rated Current	Rated Power	Coordination Type	Standard	Notes
AF09-30-10-13	400V	100A	40kW	UL	UL 489	
AF09-30-10-13	400V	100A	40kW	IEC	IEC 60947-4-1	
AF09-30-10-13	400V	100A	40kW	UL	UL 489	
AF09-30-10-13	400V	100A	40kW	IEC	IEC 60947-4-1	

SOC II: Select the Optimized Coordination tables for your starter according to IEC or UL standard

# 3-pole contactors, for motor control and power switching

1



AC / DC Control supply				Type	AF09	AF12	AF16	AF26	AF30	AF38	AF40	AF52	AF65	AF80	AF96	
IEC	AC-3	Rated operational power	220 - 230 - 240 V	kW	2.2	3	4	6.5	9	11	11	15	18.5	22	25	
			380 - 400 V	kW	4	5.5	7.5	11	15	18.5	18.5	22	30	37	45	
	AF370		415 V	kW	4	5.5	9	11	15	18.5	22	30	37	45	55	
			440 V	kW	4	5.5	9	15	18.5	22	22	30	37	45	55	
	AF2650		500 V	kW	5.5	7.5	9	15	18.5	22	22	30	37	45	55	
			690 V	kW	5.5	7.5	9	15	18.5	22	22	30	37	45	55	
		1000 V	kW	—	—	—	—	—	—	—	—	—	—	—		
		Rated operational current	380 - 400 V	A	9	12	18	26	32	38	40	53	65	80	96	
AC-1		Rated operational current	$\theta \leq 40^\circ\text{C}$ , 690 V	A	25	28	30	45	50	50	70	100	105	125	130	
UL / CSA	1-phase motor rating		120 V	hp	0.75	1	1.5	2	2	2	3	3	5	7.5	7.5	
			240 V	hp	1.5	2	3	3	5	5	7.5	10	15	15	20	
	3-phase motor rating		200 - 208 V	hp	2	3	5	7.5	10	10	10	15	20	25	30	30
			220 - 240 V	hp	2	3	5	7.5	10	10	15	20	25	30	30	
			440 - 480 V	hp	5	7.5	10	15	20	20	30	40	50	60	60	
		550 - 600 V	hp	7.5	10	15	20	25	25	40	50	60	75	75		
	General use rating		600 V	A	25	28	30	45	50	50	60	80	90	105	115	
NEMA		NEMA Size			00	0	—	1	—	—	2	—	—	3	—	

## Main accessories

Auxiliary contact blocks	Front mounting	CA4-10 (1 x N.O.) CA4-01 (1 x N.C.)
	Side mounting	CAL4-11 (1 x N.O. + 1 x N.C.)
Timers	Electronic	TEF4-ON TEF4-OFF
Interlocking units	Mechanical	VM4 VM96-4
	Mechanical / Electrical	VEM4
Connection sets	For reversing contactors	BER16-4 BER38-4 BER65-4 BER96-4
Surge suppressors		Built-in surge protection

## Overload relays

Thermal relays	 Class 10 (Class 10A for TF140, TA200DU)	TF42 (0.10...38 A)	TF65 (22...67 A)	TF96 (40...96 A)
Electronic relays	Class 10E, 20E, 30E	EF19 (0.10...18.9 A)	EF19 (0.10...18.9 A) EF45 (9...45 A)	EF65 (25...70 A) EF96 (36...100 A)

## Manual motor starters

	Thermal / magnetic protection Class 10	MS116 (0.10...32 A) SCCR up to 30 kA MS132 (0.10...32 A) SCCR up to 65 kA	MS450 (28...50 A) SCCR up to 65 kA	MS495 (45...100 A) SCCR up to 65 kA
	Magnetic only types	MO132 (0.16...32 A) SCCR up to 65 kA	MO496 (32...100 A) SCCR up to 65 kA MO450 (40...50 A) SCCR up to 65 kA	MO495 (63...100 A) SCCR up to 65 kA
Accessories	For contactor mounting	BEA16-4	BEA38-4	



AF116	AF140	AF146	AF190	AF205	AF265	AF305	AF370	AF400	AF460	AF580	AF750	AF1250	AF1350	AF1650	AF2050	AF2650
30	37	45	55	55	75	90	110	110	132	160	220	—	257	315	—	—
55	75	75	90	110	132	160	200	200	250	315	400	—	475	560	—	—
55	75	75	90	110	132	160	200	220	250	355	425	—	500	600	—	—
75	90	90	110	132	160	160	200	220	250	355	450	—	560	670	—	—
75	90	90	110	132	160	200	250	250	315	400	520	—	560	700	—	—
55	75	90	132	160	200	250	315	315	355	500	600	—	750	900	—	—
—	—	75	110	132	132	132	132	220	280	355	400	—	—	—	—	—
116	140	146	190	205	265	305	370	400	460	580	750	—	860	1050	—	—
160	200	225	275	350	400	500	600	600	700	800	1050	1260	1350	1650	2050	2650
—	—	—	—	—	—	—	—	—	—	—	—	—	—	—	—	—
—	—	—	—	—	—	—	—	—	—	—	—	—	—	—	—	—
30	40	40	50	60	75	100	125	125	150	200	250	—	—	—	—	—
40	50	50	60	75	100	125	150	150	200	250	300	—	400	450	—	—
75	100	100	125	150	200	250	300	350	400	500	600	—	800	900	—	—
100	125	125	150	200	250	300	350	400	500	600	700	—	1000	1150	—	—
160	200	200	230 (1)	250 (1)	300 (1)	350 (1)	400 (1)	550	650	750	900	1210	1350	1650	2100	2700
—	4	—	—	—	5	—	—	—	6	—	7	—	—	8	—	—

(1) Higher ratings achievable through the use of LX.. terminal extensions. See page 2.6 for additional information.

CAL19-11 (1 x N.O. + 1 x N.C.) CAL18-11 (1 x N.O. + 1 x N.C.)

VM19 (for same size contactors) VM750H VM750V VM1650H

BER140-4 BER205-4 BER370-4 BEM460-30 BEM750-30

TF140DU (66...142 A) θ ≤ 55 °C	TA200DU (66...200 A) θ ≤ 55 °C	EF370 (115...380 A)	E500DU (150...500 A)	E800DU (250...800 A)	E1250DU (375...1250 A)
EF146 (54...150 A)	EF205 (63...210 A)				

### Short-circuit protection devices

Tmax circuit breakers & OS Fusible disconnect switches



# 4-pole contactors

1

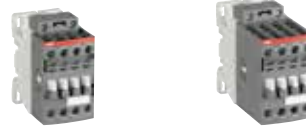

IEC	AC-1 Rated operational current	$\theta \leq 40\text{ }^\circ\text{C}$ , 690 V	A	25	30	45	55	
UL/CSA	General use rating	600 V	A	25	30	45	55	
AC / DC Control supply				Type	AF09	AF16	AF26	AF38
IEC	AC-1 Rated operational current	$\theta \leq 40\text{ }^\circ\text{C}$	A	25	30	45	55	
		$\theta \leq 55\text{ }^\circ\text{C}$ (1)	A	25	30	40	45	
		$\theta \leq 70\text{ }^\circ\text{C}$	A	22	26	32	37	
With conductor cross sectional area			mm <sup>2</sup>	4	6	10	16	
Rated operational voltage U <sub>e</sub> max.			V	690	690	690	690	
UL/CSA	General use rating	600 V	A	25	30	45	55	

(1)  $\theta \leq 60\text{ }^\circ\text{C}$  for AF09 ... AF38 contactors

## Main accessories

Auxiliary contact blocks	Front mounting	CA4-10 (1 x N.O.), CA4-01 (1 x N.C.)
	Side mounting	CAL4-11 (1 x N.O. + 1 x N.C.)
Timers	Electronic	TEF4-ON
		TEF4-OFF
Interlocking units	Mechanical	VM4
	Mechanical / Electrical	VEM4
Surge suppressors	Varistor (AC / DC)	Built-in surge protection
	RC Type (AC)	
	Transil diode (DC)	

# AF Range contactors and control relays

## Table of contents

### Selection pages

3-pole contactors .....	2.2 - 2.8
3-pole reversing contactors.....	2.9 - 2.14
3-pole NEMA rated contactors .....	2.15 - 2.20
3-pole NEMA rated reversing contactors.....	2.21 - 2.25
4-pole contactors .....	2.26 - 2.27
Control relays .....	2.28 - 2.31
Voltage code table.....	2.32 - 2.33

### Accessories

Accessory fitting details .....	2.34 - 2.40
Auxiliary contact blocks .....	2.41 - 2.45
Electronic timers.....	2.46
Interlocks .....	2.47
Mechanical latching units .....	2.48
Other accessories.....	2.49 - 2.50
Terminal shrouds and mechanical lugs.....	2.51
Terminal enlargements and extensions.....	2.52
Terminal connecting strips and shorting bars.....	2.53
Reversing and phase-to-phase bus kits .....	2.54
Wye-delta bus kits .....	2.55
Coupling units .....	2.56 - 2.57
Mounting and adaptor plates.....	2.58 - 2.59
Service parts .....	2.60

### Technical data

3-pole contactors .....	2.61 - 2.77
4-pole contactors .....	2.78 - 2.81
Control relays .....	2.82 - 2.84
Auxiliary contact blocks .....	2.85 - 2.88
Electronic timers.....	2.89 - 2.90
Interlocks .....	2.91
Mechanical latching units .....	2.92

### Terminal marking and positioning

3-pole contactors .....	2.93 - 2.95
4-pole contactors .....	2.96
Control relays .....	2.97
Add-on auxiliary contacts.....	2.98

# AF09 ... AF38 3-pole contactors

## 5 to 20 hp at 480 V AC

### AC / DC operated

2



AF09-30-10



AF26-30-00

#### Description

AF09 ... AF38 contactors are mainly used for controlling 3-phase motors and power circuits up to 690 V AC and 220 V DC. These contactors are of the block type design with 3 main poles.

- control circuit: AC or DC operated with electronic coil interface accepting a wide control voltage range (e.g. 100...250 V AC and DC), only 4 control voltage ranges covering 24...500V 50/60 Hz and 20...500 V DC
- can manage large control voltage variations
- reduced panel energy consumption
- very distinct closing and opening.
- built-in surge suppression
- add-on auxiliary contact blocks for front or side mounting and a wide range of accessories.

#### Ordering details

IEC		UL/CSA		Rated control circuit voltage		Auxiliary contacts fitted	Catalog number	Global reference code	Weight	
Rated operational power	current $\theta \leq 40^\circ\text{C}$	3-phase motor rating 480 V	General use rating 600 V AC	Uc min. ...	Uc max.					Pkg (1 pce)
400 V AC-3	AC-1	hp	A	V 50/60 Hz	V DC				kg	
4	25	5	25	24...60	-	(1)	1 0	AF09-30-10-41	1SBL137001R4110	0.270
							0 1	AF09-30-01-41	1SBL137001R4101	0.270
							1 0	AF09-30-10-12	1SBL137001R1210	0.270
							0 1	AF09-30-01-12	1SBL137001R1201	0.270
							1 0	AF09-30-10-13	1SBL137001R1310	0.270
							0 1	AF09-30-01-13	1SBL137001R1301	0.270
							1 0	AF09-30-10-14	1SBL137001R1410	0.310
							0 1	AF09-30-01-14	1SBL137001R1401	0.310
							1 0	AF12-30-10-41	1SBL157001R4110	0.270
							0 1	AF12-30-01-41	1SBL157001R4101	0.270
1 0	AF12-30-10-12	1SBL157001R1210	0.270							
0 1	AF12-30-01-12	1SBL157001R1201	0.270							
1 0	AF12-30-10-13	1SBL157001R1310	0.270							
0 1	AF12-30-01-13	1SBL157001R1301	0.270							
1 0	AF12-30-10-14	1SBL157001R1410	0.310							
0 1	AF12-30-01-14	1SBL157001R1401	0.310							
5.5	28	7.5	28	24...60	-	(1)	1 0	AF12-30-10-41	1SBL157001R4110	0.270
							0 1	AF12-30-01-41	1SBL157001R4101	0.270
							1 0	AF12-30-10-12	1SBL157001R1210	0.270
							0 1	AF12-30-01-12	1SBL157001R1201	0.270
							1 0	AF12-30-10-13	1SBL157001R1310	0.270
							0 1	AF12-30-01-13	1SBL157001R1301	0.270
							1 0	AF12-30-10-14	1SBL157001R1410	0.310
							0 1	AF12-30-01-14	1SBL157001R1401	0.310
							1 0	AF16-30-10-41	1SBL177001R4110	0.270
							0 1	AF16-30-01-41	1SBL177001R4101	0.270
1 0	AF16-30-10-12	1SBL177001R1210	0.270							
0 1	AF16-30-01-12	1SBL177001R1201	0.270							
1 0	AF16-30-10-13	1SBL177001R1310	0.270							
0 1	AF16-30-01-13	1SBL177001R1301	0.270							
1 0	AF16-30-10-14	1SBL177001R1410	0.310							
0 1	AF16-30-01-14	1SBL177001R1401	0.310							
7.5	30	10	30	24...60	-	(1)	1 0	AF16-30-10-41	1SBL177001R4110	0.270
							0 1	AF16-30-01-41	1SBL177001R4101	0.270
							1 0	AF16-30-10-12	1SBL177001R1210	0.270
							0 1	AF16-30-01-12	1SBL177001R1201	0.270
							1 0	AF16-30-10-13	1SBL177001R1310	0.270
0 1	AF16-30-01-13	1SBL177001R1301	0.270							
1 0	AF16-30-10-14	1SBL177001R1410	0.310							
0 1	AF16-30-01-14	1SBL177001R1401	0.310							
11	45	15	45	24...60	-	(1)	0 0	AF26-30-00-41	1SBL237001R4100	0.310
							0 0	AF26-30-00-12	1SBL237001R1200	0.310
							0 0	AF26-30-00-13	1SBL237001R1300	0.310
							0 0	AF26-30-00-14	1SBL237001R1400	0.350
							0 0	AF30-30-00-41	1SBL277001R4100	0.310
0 0	AF30-30-00-12	1SBL277001R1200	0.310							
0 0	AF30-30-00-13	1SBL277001R1300	0.310							
0 0	AF30-30-00-14	1SBL277001R1400	0.350							
15	50	20	50	24...60	-	(1)	0 0	AF30-30-00-41	1SBL277001R4100	0.310
							0 0	AF30-30-00-12	1SBL277001R1200	0.310
							0 0	AF30-30-00-13	1SBL277001R1300	0.310
							0 0	AF30-30-00-14	1SBL277001R1400	0.350
							0 0	AF38-30-00-41	1SBL297001R4100	0.310
0 0	AF38-30-00-12	1SBL297001R1200	0.310							
0 0	AF38-30-00-13	1SBL297001R1300	0.310							
0 0	AF38-30-00-14	1SBL297001R1400	0.350							

(1) For 24...60 V 50/60 Hz - 20...60 V DC, use AF..-30-..-11 (see voltage code table). AF..-30-..-11 not suitable for direct control by PLC-output.

#### Main dimensions mm, inches

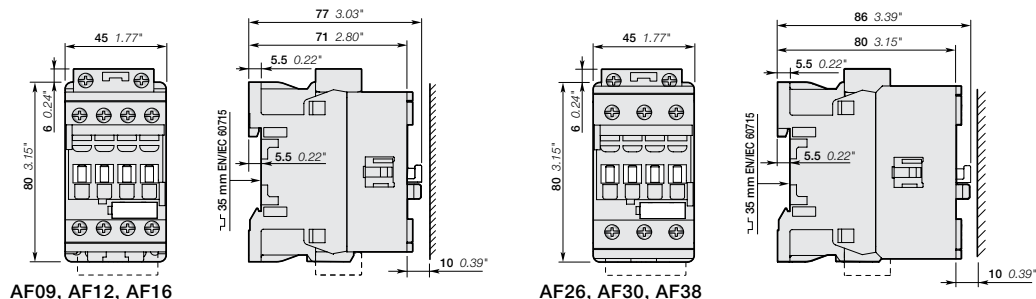



# AF09Z ... AF38Z 3-pole contactors

## 5 to 20 hp at 480 V AC

### AC / DC operated - low consumption



AF09Z-30-10



AF26Z-30-00

#### Description

AF09Z ... AF38Z contactors are mainly used for controlling 3-phase motors and power circuits up to 690 V AC and 220 V DC. These contactors are of the block type design with 3 main poles.

- control circuit: AC or DC operated with electronic coil interface accepting a wide control voltage range (e.g. 100...250 V AC and DC), only 4 control voltage ranges covering 24...250 V 50/60 Hz and 12...250 V DC
- can manage large control voltage variations
- allow direct control by PLC-output  $\geq 24$  V DC 500 mA
- reduced panel energy consumption
- very distinct closing and opening
- can withstand short voltage dips and voltage sags (SEMI F47-0706 conditions of use on request).
- built-in surge suppression
- add-on auxiliary contact blocks for front or side mounting and a wide range of accessories.

#### Ordering details

IEC Rated operational power	UL/CSA 3-phase motor rating 480 V	General use rating 600 V AC	Rated control circuit voltage Uc min. ... Uc max. (1)		Auxiliary contacts fitted	Catalog number	Global reference code	Weight Pkg (1 pce) kg										
			V 50/60 Hz	V DC														
400 V AC-3 kW	AC-1 A	hp	A	V 50/60 Hz	V DC													
									4	25	5	25	-	12...20	1 0	AF09Z-30-10-20	1SBL136001R2010	0.310
													24...60	20...60	0 1	AF09Z-30-01-20	1SBL136001R2001	0.310
															1 0	AF09Z-30-10-21	1SBL136001R2110	0.310
															0 1	AF09Z-30-01-21	1SBL136001R2101	0.310
													48...130	48...130	1 0	AF09Z-30-10-22	1SBL136001R2210	0.310
															0 1	AF09Z-30-01-22	1SBL136001R2201	0.310
													100...250	100...250	1 0	AF09Z-30-10-23	1SBL136001R2310	0.310
															0 1	AF09Z-30-01-23	1SBL136001R2301	0.310
															1 0	AF12Z-30-10-20	1SBL156001R2010	0.310
															0 1	AF12Z-30-01-20	1SBL156001R2001	0.310
													24...60	20...60	1 0	AF12Z-30-10-21	1SBL156001R2110	0.310
						0 1	AF12Z-30-01-21	1SBL156001R2101	0.310									
				48...130	48...130	1 0	AF12Z-30-10-22	1SBL156001R2210	0.310									
						0 1	AF12Z-30-01-22	1SBL156001R2201	0.310									
				100...250	100...250	1 0	AF12Z-30-10-23	1SBL156001R2310	0.310									
						0 1	AF12Z-30-01-23	1SBL156001R2301	0.310									
						1 0	AF16Z-30-10-20	1SBL176001R2010	0.310									
						0 1	AF16Z-30-01-20	1SBL176001R2001	0.310									
				24...60	20...60	1 0	AF16Z-30-10-21	1SBL176001R2110	0.310									
						0 1	AF16Z-30-01-21	1SBL176001R2101	0.310									
				48...130	48...130	1 0	AF16Z-30-10-22	1SBL176001R2210	0.310									
						0 1	AF16Z-30-01-22	1SBL176001R2201	0.310									
				100...250	100...250	1 0	AF16Z-30-10-23	1SBL176001R2310	0.310									
						0 1	AF16Z-30-01-23	1SBL176001R2301	0.310									
						0 0	AF26Z-30-00-20	1SBL236001R2000	0.350									
				24...60	20...60	0 0	AF26Z-30-00-21	1SBL236001R2100	0.350									
				48...130	48...130	0 0	AF26Z-30-00-22	1SBL236001R2200	0.350									
				100...250	100...250	0 0	AF26Z-30-00-23	1SBL236001R2300	0.350									
						0 0	AF30Z-30-00-20	1SBL276001R2000	0.350									
				24...60	20...60	0 0	AF30Z-30-00-21	1SBL276001R2100	0.350									
				48...130	48...130	0 0	AF30Z-30-00-22	1SBL276001R2200	0.350									
				100...250	100...250	0 0	AF30Z-30-00-23	1SBL276001R2300	0.350									
						0 0	AF38Z-30-00-20	1SBL296001R2000	0.350									
				24...60	20...60	0 0	AF38Z-30-00-21	1SBL296001R2100	0.350									
				48...130	48...130	0 0	AF38Z-30-00-22	1SBL296001R2200	0.350									
				100...250	100...250	0 0	AF38Z-30-00-23	1SBL296001R2300	0.350									

(1) Note: Only AF.Z contactors with DC control voltage 12...20 V DC need to respect the connection polarities indicated close to the coil terminals: A1+ for the positive pole and A2- for the negative pole.

#### Main dimensions mm, inches

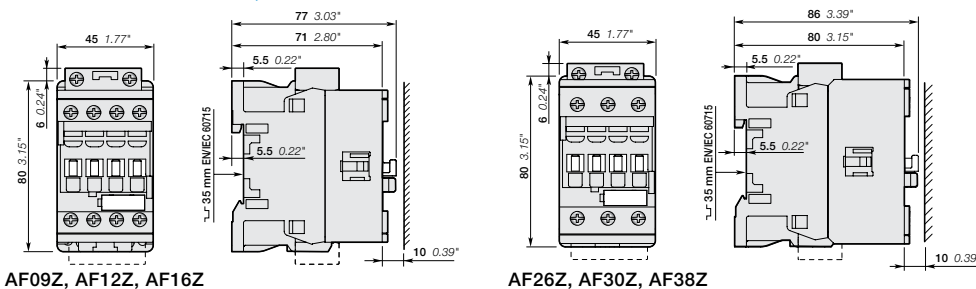

AF09Z, AF12Z, AF16Z

AF26Z, AF30Z, AF38Z

# AF40 ... AF96 3-pole contactors

## 30 to 60 hp at 480 V AC

### AC / DC operated with 1 N.O. + 1 N.C. auxiliary contacts

2



AF40-30-11



AF80-30-11

#### Description

AF40 ... AF96 contactors are mainly used for controlling 3-phase motors and power circuits up to 690 V AC and 220 V DC. These contactors are of the block type design with 3 main poles.

- control circuit: AC or DC operated with electronic coil interface accepting a wide control voltage range (e.g. 100...250 V AC and DC), only 4 control voltage ranges covering 24...500 V 50/60 Hz and 20...500 V DC
- can manage large control voltage variations
- reduced panel energy consumption
- very distinct closing and opening.
- built-in surge suppression
- add-on auxiliary contact blocks for front or side mounting and a wide range of accessories.

#### Ordering details

IEC		UL / CSA		Rated control circuit voltage		Auxiliary contacts fitted	Catalog number	Global reference code	Weight Pkg (1 pce)
Rated operational power	current $\theta \leq 40^\circ\text{C}$	3-phase motor rating	General use rating	Uc min. ... Uc max.					
400 V AC-3	AC-1	hp	A	V 50/60 Hz	V DC				kg
18.5	70	30	60	24...60	-	1 1	AF40-30-11-41	1SBL347001R4111	1.010
				24...60	20...60 (1)	1 1	AF40-30-11-11	1SBL347001R1111	1.010
				48...130	48...130	1 1	AF40-30-11-12	1SBL347001R1211	1.010
				100...250	100...250	1 1	AF40-30-11-13	1SBL347001R1311	1.000
22	100	40	80	250...500	250...500	1 1	AF40-30-11-14	1SBL347001R1411	1.000
				24...60	-	1 1	AF52-30-11-41	1SBL367001R4111	1.010
				24...60	20...60 (1)	1 1	AF52-30-11-11	1SBL367001R1111	1.010
				48...130	48...130	1 1	AF52-30-11-12	1SBL367001R1211	1.010
30	105	50	90	100...250	100...250	1 1	AF52-30-11-13	1SBL367001R1311	1.000
				250...500	250...500	1 1	AF52-30-11-14	1SBL367001R1411	1.000
				24...60	-	1 1	AF65-30-11-41	1SBL387001R4111	1.010
				24...60	20...60 (1)	1 1	AF65-30-11-11	1SBL387001R1111	1.010
37	125	60	105	48...130	48...130	1 1	AF65-30-11-12	1SBL387001R1211	1.010
				100...250	100...250	1 1	AF65-30-11-13	1SBL387001R1311	1.000
				250...500	250...500	1 1	AF65-30-11-14	1SBL387001R1411	1.000
				24...60	-	1 1	AF80-30-11-41	1SBL397001R4111	1.260
45	130	60	115	24...60	20...60 (1)	1 1	AF80-30-11-11	1SBL397001R1111	1.260
				48...130	48...130	1 1	AF80-30-11-12	1SBL397001R1211	1.260
				100...250	100...250	1 1	AF80-30-11-13	1SBL397001R1311	1.210
				250...500	250...500	1 1	AF80-30-11-14	1SBL397001R1411	1.210
45	130	60	115	24...60	20...60 (1)	1 1	AF96-30-11-11	1SBL407001R1111	1.260
				48...130	48...130	1 1	AF96-30-11-12	1SBL407001R1211	1.260
				100...250	100...250	1 1	AF96-30-11-13	1SBL407001R1311	1.210
				250...500	250...500	1 1	AF96-30-11-14	1SBL407001R1411	1.210

(1) AF.-30-...-11 not suitable for direct control by PLC-output.

#### Main dimensions mm, inches

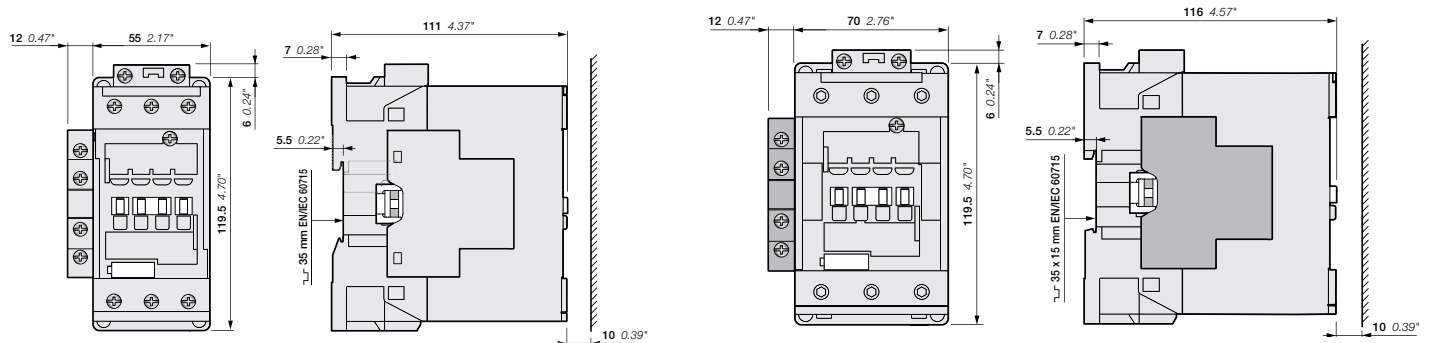

AF40, AF52, AF65

AF80, AF96

# AF116 ... AF146 3-pole contactors

## 75 to 100 hp at 480 V AC

### AC / DC operated with 1 N.O. + 1 N.C. auxiliary contacts



AF146-30-11



AF146-30-11B

#### Description

AF116 ... AF140 contactors are mainly used for controlling 3-phase motors and power circuits up to 690 V AC, AF146 up to 1000 V AC. These contactors are of the block type design with 3 main poles.

- Control circuit: AC or DC operated with electronic coil interface accepting a wide control voltage range (e.g. 100...250 V AC and DC), only 4 control voltage ranges covering 24...500 V 50/60 Hz and 20...500 V DC
- can manage large control voltage variations
- reduced panel energy consumption
- very distinct closing and opening
- can withstand short voltage dips and voltage sags (SEMI F47 conditions of use on request).
- built-in surge suppression
- add-on auxiliary contact blocks for side mounting and a wide range of accessories.

#### Ordering details

IEC		UL / CSA		Rated control circuit voltage		Auxiliary contacts fitted		Catalog number	Global reference code	Weight Pkg (1 pce)
Rated operational power	operational current $\theta \leq 40^\circ\text{C}$	3-phase motor rating	General use rating	Uc min. ... Uc max.						
400 V AC-3	AC-1	480 V	600 V AC	V 50/60 Hz	V DC					kg
kW	A	hp	A							

#### For connection with built-in cable clamps

Rated operational power (kW)	operational current (A)	3-phase motor rating (hp)	General use rating (A)	Uc min. (V 50/60 Hz)	Uc max. (V DC)	N.O.	N.C.	Catalog number	Global reference code	Weight (kg)
55	160	75	160	24...60	20...60	1	1	AF116-30-11-11	1SFL427001R1111	1.750
				48...130	48...130	1	1	AF116-30-11-12	1SFL427001R1211	1.750
				100...250	100...250	1	1	AF116-30-11-13	1SFL427001R1311	1.750
				250...500	250...500	1	1	AF116-30-11-14	1SFL427001R1411	1.750
75	200	100	200	24...60	20...60	1	1	AF140-30-11-11	1SFL447001R1111	1.750
				48...130	48...130	1	1	AF140-30-11-12	1SFL447001R1211	1.750
				100...250	100...250	1	1	AF140-30-11-13	1SFL447001R1311	1.750
				250...500	250...500	1	1	AF140-30-11-14	1SFL447001R1411	1.750
75	225	100	200	24...60	20...60	1	1	AF146-30-11-11	1SFL467001R1111	1.750
				48...130	48...130	1	1	AF146-30-11-12	1SFL467001R1211	1.750
				100...250	100...250	1	1	AF146-30-11-13	1SFL467001R1311	1.750
				250...500	250...500	1	1	AF146-30-11-14	1SFL467001R1411	1.750

#### With bar connections

Rated operational power (kW)	operational current (A)	3-phase motor rating (hp)	General use rating (A)	Uc min. (V 50/60 Hz)	Uc max. (V DC)	N.O.	N.C.	Catalog number	Global reference code	Weight (kg)
55	160	75	160	24...60	20...60	1	1	AF116-30-11B-11	1SFL427002R1111	1.500
				48...130	48...130	1	1	AF116-30-11B-12	1SFL427002R1211	1.500
				100...250	100...250	1	1	AF116-30-11B-13	1SFL427002R1311	1.500
				250...500	250...500	1	1	AF116-30-11B-14	1SFL427002R1411	1.500
75	200	100	200	24...60	20...60	1	1	AF140-30-11B-11	1SFL447002R1111	1.500
				48...130	48...130	1	1	AF140-30-11B-12	1SFL447002R1211	1.500
				100...250	100...250	1	1	AF140-30-11B-13	1SFL447002R1311	1.500
				250...500	250...500	1	1	AF140-30-11B-14	1SFL447002R1411	1.500
75	225	100	200	24...60	20...60	1	1	AF146-30-11B-11	1SFL467002R1111	1.500
				48...130	48...130	1	1	AF146-30-11B-12	1SFL467002R1211	1.500
				100...250	100...250	1	1	AF146-30-11B-13	1SFL467002R1311	1.500
				250...500	250...500	1	1	AF146-30-11B-14	1SFL467002R1411	1.500

#### Main dimensions mm, inches

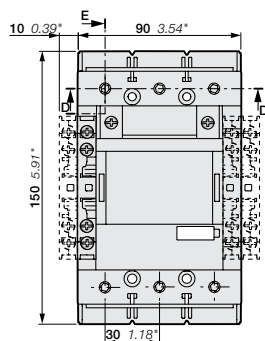

AF116, AF140, AF146-30-11

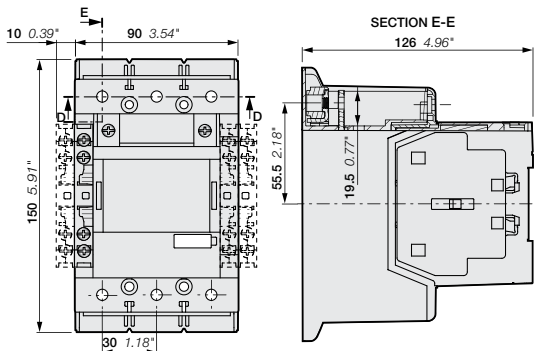

AF116, AF140, AF146-30-11B

# AF190 ... AF370 3-pole contactors

## 125 to 300 hp at 480 V AC

### AC / DC operated with 1 N.O. + 1 N.C. auxiliary contacts

2



AF205-30-11



AF370-30-11

#### Description

AF190 ... AF370 contactors are mainly used for controlling 3-phase motors and power circuits up to 1000 V AC. These contactors are of the block type design with 3 main poles.

- control circuit: AC or DC operated with electronic coil interface accepting a wide control voltage range (e.g. 100...250 V AC and DC), only 4 control voltage ranges covering 24...500 V 50/60 Hz and 20...500 V DC
- can manage large control voltage variations
- reduced panel energy consumption
- very distinct closing and opening
- can withstand short voltage dips and voltage sags (SEMI F47 conditions of use on request).
- built-in surge suppression
- add-on auxiliary contact blocks for side mounting and a wide range of accessories.

#### Ordering details

IEC		UL / CSA		Rated control circuit voltage		Auxiliary contacts fitted	Catalog number	Global reference code	Weight
Rated operational power	current $\theta \leq 40^\circ\text{C}$	3-phase motor rating	General use rating	Uc min. ... Uc max.					
400 V AC-3	AC-1	480 V	600 V AC	V 50/60 Hz	V DC				kg
90	275	125	230 [250]	24...60	20...60	1 1	AF190-30-11-11	1SFL487002R1111	3.000
				48...130	48...130	1 1	AF190-30-11-12	1SFL487002R1211	3.000
				100...250	100...250	1 1	AF190-30-11-13	1SFL487002R1311	3.000
				250...500	250...500	1 1	AF190-30-11-14	1SFL487002R1411	3.000
110	350	150	250 [300]	24...60	20...60	1 1	AF205-30-11-11	1SFL527002R1111	3.000
				48...130	48...130	1 1	AF205-30-11-12	1SFL527002R1211	3.000
				100...250	100...250	1 1	AF205-30-11-13	1SFL527002R1311	3.000
				250...500	250...500	1 1	AF205-30-11-14	1SFL527002R1411	3.000
140	400	200	300 [350]	24...60	20...60	1 1	AF265-30-11-11	1SFL547002R1111	4.640
				48...130	48...130	1 1	AF265-30-11-12	1SFL547002R1211	4.640
				100...250	100...250	1 1	AF265-30-11-13	1SFL547002R1311	4.640
				250...500	250...500	1 1	AF265-30-11-14	1SFL547002R1411	4.640
160	500	250	350 [400]	24...60	20...60	1 1	AF305-30-11-11	1SFL587002R1111	4.640
				48...130	48...130	1 1	AF305-30-11-12	1SFL587002R1211	4.640
				100...250	100...250	1 1	AF305-30-11-13	1SFL587002R1311	4.640
				250...500	250...500	1 1	AF305-30-11-14	1SFL587002R1411	4.640
200	600	300	400 [520]	24...60	20...60	1 1	AF370-30-11-11	1SFL607002R1111	4.640
				48...130	48...130	1 1	AF370-30-11-12	1SFL607002R1211	4.640
				100...250	100...250	1 1	AF370-30-11-13	1SFL607002R1311	4.640
				250...500	250...500	1 1	AF370-30-11-14	1SFL607002R1411	4.640

(1) The higher ratings shown in [brackets] can be achieved through the use of LX.. terminal extensions.

#### Main dimensions mm, inches

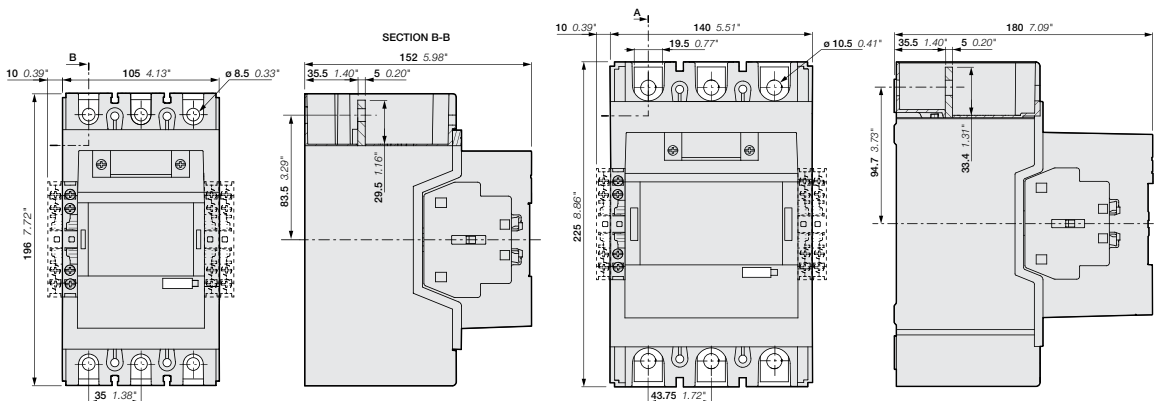

AF190, AF205

AF265, AF305, AF370

# AF400 ... AF750 3-pole contactors

## 350 to 600 hp at 480 V AC

### AC / DC operated with 1 N.O. + 1 N.C. auxiliary contacts



AF460-30-11



AF750-30-11

#### Description

AF400 ... AF750 contactors are mainly used for controlling 3-phase motors and power circuits up to 1000 V AC or 600 V DC (2). These contactors are of the block type design with 3 main poles.

- control circuit: AC or DC operated with electronic coil interface accepting a wide control voltage range (e.g. 100...250 V AC and DC), only 4 coils to cover control voltages between 48...500 V 50/60 Hz and 24...500 V DC
  - can manage large control voltage variations
  - reduced panel energy consumption
  - very distinct closing and opening
  - can withstand short voltage dips and voltages sags (SEMI F47 conditions of use on request).
- built-in surge suppression
- add-on auxiliary contact blocks for side mounting and a wide range of accessories.

#### Ordering details

IEC		UL/CSA		Rated control circuit voltage		Auxiliary contacts fitted	Catalog number	Global reference code	Weight
Rated operational power	operational current $\theta \leq 40^\circ\text{C}$	3-phase motor rating	General use rating	Uc min. ... Uc max.					
400 V AC-3	690 V AC-1	hp	A	V 50/60 Hz	V DC	kg			
200	600	350	550	-	24...60 (1)	1 1	AF400-30-11-68	1SFL577001R6811	12.000
				48...130	48...130	1 1	AF400-30-11-69	1SFL577001R6911	12.000
				100...250	100...250	1 1	AF400-30-11-70	1SFL577001R7011	12.000
				250...500	250...500	1 1	AF400-30-11-71	1SFL577001R7111	12.000
250	700	400	650	-	24...60 (1)	1 1	AF460-30-11-68	1SFL597001R6811	12.000
				48...130	48...130	1 1	AF460-30-11-69	1SFL597001R6911	12.000
				100...250	100...250	1 1	AF460-30-11-70	1SFL597001R7011	12.000
				250...500	250...500	1 1	AF460-30-11-71	1SFL597001R7111	12.000
315	800	500	750	-	24...60 (1)	1 1	AF580-30-11-68	1SFL617001R6811	15.000
				48...130	48...130	1 1	AF580-30-11-69	1SFL617001R6911	15.000
				100...250	100...250	1 1	AF580-30-11-70	1SFL617001R7011	15.000
				250...500	250...500	1 1	AF580-30-11-71	1SFL617001R7111	15.000
400	1050	600	900	-	24...60 (1)	1 1	AF750-30-11-68	1SFL637001R6811	15.000
				48...130	48...130	1 1	AF750-30-11-69	1SFL637001R6911	15.000
				100...250	100...250	1 1	AF750-30-11-70	1SFL637001R7011	15.000
				250...500	250...500	1 1	AF750-30-11-71	1SFL637001R7111	15.000

(1) The connection polarities indicated close to the coil terminals must be respected: A1 for the positive pole and A2 for the negative pole.  
 (2) Up to 850 V DC for AF580, AF750.

#### Control inputs

AF400 ... AF750 are equipped with low voltage inputs for control, for example by a PLC.

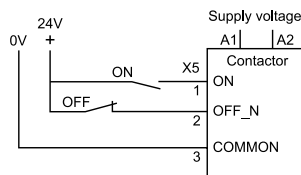

#### Main dimensions mm, inches

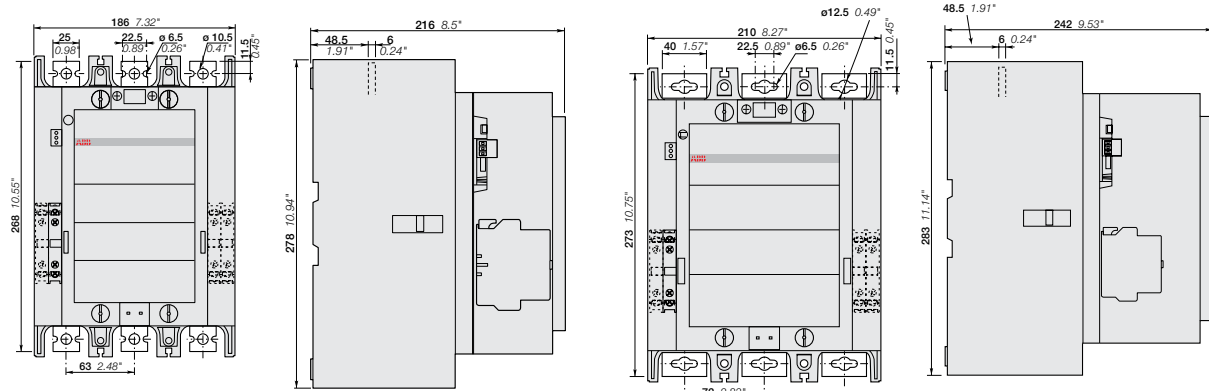

AF400, AF460

AF580, AF750

# AF1250 ... AF2650 3-pole contactors

## 800 to 900 hp at 480 V AC and up to 2700 A general use AC / DC operated with 1 N.O. + 1 N.C. auxiliary contacts

2



AF1250-30-11



AF2650-30-11

### Description

AF1250 ... AF2050 contactors are mainly used for controlling power circuits up to 1000 V AC or 850 V DC, AF2650 for controlling power up to 1000 V AC. These contactors are of the block type design with 3 main poles.

- control circuit: AC or DC operated with electronic coil interface accepting a wide control voltage range (e.g. 100...250 V AC and DC)

- only 4 coils for AF1250 to cover control voltages between 48...500 V 50/60 Hz and 24...500 V DC  
 - only 1 coil for AF1350 ... AF2650 to cover control voltages between 100...250 V 50/60 Hz and 100...250 V DC

- can manage large control voltage variations
- reduced panel energy consumption
- very distinct closing and opening
- can withstand short voltage dips and voltages sags (SEMI F47 conditions of use on request).

- built-in surge suppression

- add-on auxiliary contact blocks for side mounting and a wide range of accessories.

### Ordering details

IEC Rated operational power 400 V AC-3 kW	UL/CSA 3-phase motor rating 480 V hp	General use rating 600 V AC A (2)	Rated control circuit voltage U <sub>c</sub> (1)		Auxiliary contacts fitted	Catalog number	Global reference code	Weight Pkg (1 pce) kg	
			V 50/60 Hz	V DC					
-	1260	-	1210	-	24...60 (1)	1 1	AF1250-30-11-68	1SFL647001R6811	16.000
				48...130	48...130	1 1	AF1250-30-11-69	1SFL647001R6911	16.000
				100...250	100...250	1 1	AF1250-30-11-70	1SFL647001R7011	16.000
				250...500	250...500	1 1	AF1250-30-11-71	1SFL647001R7111	16.000
475	1350	800	1350	100...250	100...250	1 1	AF1350-30-11-70	1SFL657001R7011	34.000
560	1650	900	1650	100...250	100...250	1 1	AF1650-30-11-70	1SFL677001R7011	35.000
-	2050	-	2100	100...250	100...250	1 1	AF2050-30-11-70	1SFL707001R7011	35.000
-	2650	-	2700	100...250	100...250	1 1	AF2650-30-11-70	1SFL667001R7011	45.000

(1) The connection polarities indicated close to the coil terminals must be respected: A1 for the positive pole and A2 for the negative pole.

(2) AF2650 : Maximum operational voltage = 1000 V according to UL / CSA.

### Control inputs

AF1250 ... AF2650 are equipped with low voltage inputs for control, for example by a PLC

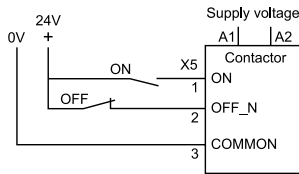

	AF1350, AF1650, AF2050	AF2650
A	392 mm / 15.43"	422 mm / 16.61"
B	47 mm / 1.85"	53.5 mm / 2.11"
C	10 mm / 0.39"	25 mm / 0.98"
D	3 mm / 0.12"	-

### Main dimensions mm, inches

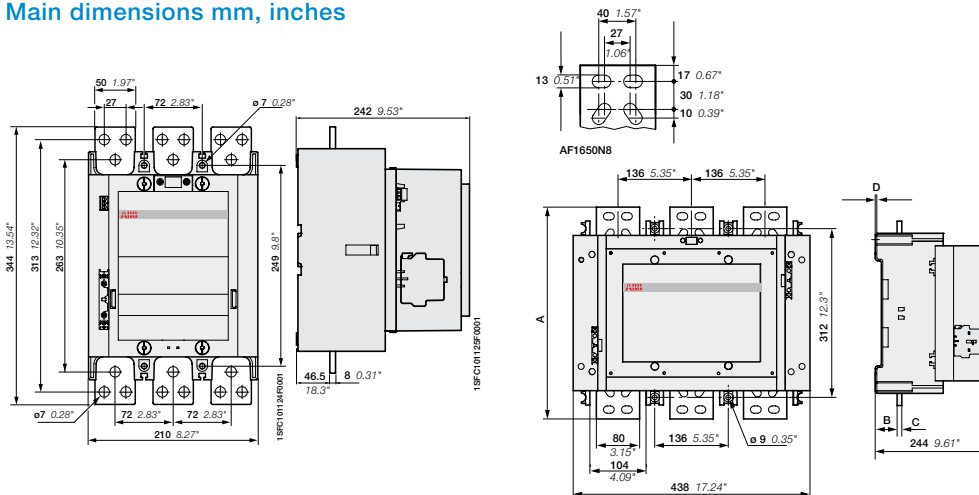

AF1250

AF1350, AF1650, AF2050, AF2650

# AF09R ... AF30R 3-pole reversing contactors

## 5 to 20 hp at 480 V AC

### AC / DC operated



AF09R-30-22

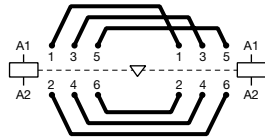

Power bus diagram

#### Description

- AF09R ... AF30R reversing contactors are mainly used for directionally controlling 3-phase motor circuits up to 690V AC. These devices include two 3-pole contactors, a mechanical and electrical interlock, power bus (see diagram to the left), and are assembled using fixing clips.
- **Note: for mechanically and electrically interlocked devices without power bus, replace the R in the catalog number with an M (ie. AF09R-30-22-13 becomes AF09M-30-22-13).**
- Control circuit: AC or DC operated with electronic coil interface accepting a wide control voltage range (e.g. 100...250 V AC and DC), only 4 control voltage ranges covering 24...500V 50/60 Hz and 20...500 V DC
  - can manage large control voltage variations
  - reduced panel energy consumption
  - very distinct closing and opening.
- Built-in surge suppression
- Add-on auxiliary contact blocks for front or side mounting and a wide range of accessories.

#### Ordering details

IEC		UL/CSA		Rated control circuit voltage		Auxiliary contacts fitted		Catalog number	Global reference code (3)	Weight Pkg (1 pce)
Rated operational power	Rated operational current $\theta \leq 40^\circ\text{C}$	3-phase motor rating	General use rating	Uc min. ... Uc max.						
400 V AC-3	AC-1	480 V	600 V AC	V 50/60 Hz	V DC					kg
4	25	5	25	24...60	-	(1)	2 2	AF09R-30-22-41		0.622
				48...130	48...130		2 2	AF09R-30-22-12		0.622
				100...250	100...250		2 2	AF09R-30-22-13		0.622
				250...500	250...500		2 2	AF09R-30-22-14		0.702
5.5	28	7.5	28	24...60	-	(1)	2 2	AF12R-30-22-41		0.622
				48...130	48...130		2 2	AF12R-30-22-12		0.622
				100...250	100...250		2 2	AF12R-30-22-13		0.622
				250...500	250...500		2 2	AF12R-30-22-14		0.702
7.5	30	10	30	24...60	-	(1)	2 2	AF16R-30-22-41		0.622
				48...130	48...130		2 2	AF16R-30-22-12		0.622
				100...250	100...250		2 2	AF16R-30-22-13		0.622
				250...500	250...500		2 2	AF16R-30-22-14		0.702
11	45	15	45	24...60	-	(1)	0 2	AF26R-30-02-41		0.757
							2 2	AF26R-30-22-41		0.785
				48...130	48...130		0 2	AF26R-30-02-12		0.757
							2 2	AF26R-30-22-12		0.785
				100...250	100...250		0 2	AF26R-30-02-13		0.757
							2 2	AF26R-30-22-13		0.785
				250...500	250...500		0 2	AF26R-30-02-14		0.837
							2 2	AF26R-30-22-14		0.865
15	50	20	50	24...60	-	(1)	0 2	AF30R-30-02-41		0.757
							2 2	AF30R-30-22-41		0.785
				48...130	48...130		0 2	AF30R-30-02-12		0.757
							2 2	AF30R-30-22-12		0.785
				100...250	100...250		0 2	AF30R-30-02-13		0.757
							2 2	AF30R-30-22-13		0.785
				250...500	250...500		0 2	AF30R-30-02-14		0.837
							2 2	AF30R-30-22-14		0.865

(1) For 24...60 V 50/60 Hz - 20...60 V DC, use AF.-30-.-11 (see voltage code table). AF.-30-.-11 not suitable for direct control by PLC-output.  
 (2) Normally closed contacts included as part of the electrical interlock. Normally open auxiliaries are either integral or front-mount.  
 (3) Available in the US and Canada only.

#### Mounting dimensions mm, inches

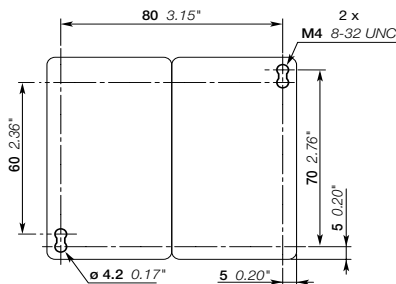

AF09R, AF12R, AF16R

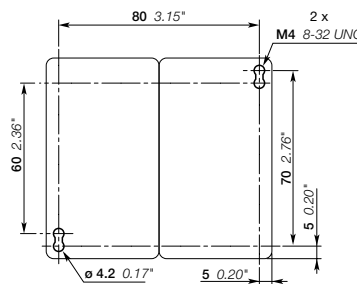

AF26R, AF30R

# AF09ZR ... AF30ZR 3-pole reversing contactors

## 5 to 20 hp at 480 V AC

### AC / DC operated - low consumption



AF09ZR-30-22

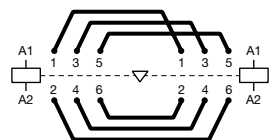

Power bus diagram

#### Description

- AF09ZR ... AF30ZR reversing contactors are mainly used for directionally controlling 3-phase motor circuits up to 690V AC. These devices include two 3-pole contactors, a mechanical and electrical interlock, power bus (see diagram to the left), and are assembled using fixing clips.
- **Note: for mechanically and electrically interlocked devices without power bus, replace the R in the catalog number with an M (ie. AF09ZR-30-22-23 becomes AF09ZM-30-22-23).**
- Control circuit: AC or DC operated with electronic coil interface accepting a wide control voltage
- Range (e.g. 100...250 V AC and DC), only 4 control voltage ranges covering 24...250 V 50/60 Hz and 20...250 V DC
  - can manage large control voltage variations
  - allow direct control by PLC-output  $\geq 24$  V DC 500 mA
  - reduced panel energy consumption
  - very distinct closing and opening
  - can withstand short voltage dips and voltage sags (SEMI F47-0706 conditions of use on request).
- Built-in surge suppression
- Add-on auxiliary contact blocks for front or side mounting and a wide range of accessories.

#### Ordering details

IEC Rated operational power kW	UL/CSA 3-phase motor rating 480 V AC-1 A	General use rating 600 V AC hp	Rated control circuit voltage Uc min. ... Uc max.		Auxiliary contacts fitted (1)	Catalog number	Global reference code (2)	Weight Pkg (1 pce) kg	
			V 50/60 Hz	V DC					
4	25	5	25	24...60	20...60	2	2	AF09ZR-30-22-21	0.702
				48...130	48...130	2	2	AF09ZR-30-22-22	0.702
				100...250	100...250	2	2	AF09ZR-30-22-23	0.702
5.5	28	7.5	28	24...60	20...60	2	2	AF12ZR-30-22-21	0.702
				48...130	48...130	2	2	AF12ZR-30-22-22	0.702
				100...250	100...250	2	2	AF12ZR-30-22-23	0.702
7.5	30	10	30	24...60	20...60	2	2	AF16ZR-30-22-21	0.702
				48...130	48...130	2	2	AF16ZR-30-22-22	0.702
				100...250	100...250	2	2	AF16ZR-30-22-23	0.702
11	45	15	45	24...60	20...60	0	2	AF26ZR-30-02-21	0.837
				48...130	48...130	2	2	AF26ZR-30-02-22	0.837
				100...250	100...250	2	2	AF26ZR-30-02-23	0.837
				24...60	20...60	2	2	AF26ZR-30-22-21	0.865
				48...130	48...130	2	2	AF26ZR-30-22-22	0.865
				100...250	100...250	2	2	AF26ZR-30-22-23	0.865
15	50	20	50	24...60	20...60	0	2	AF30ZR-30-02-21	0.837
				48...130	48...130	2	2	AF30ZR-30-02-22	0.837
				100...250	100...250	2	2	AF30ZR-30-02-23	0.865
				24...60	20...60	2	2	AF30ZR-30-22-21	0.865
				48...130	48...130	2	2	AF30ZR-30-22-22	0.837
				100...250	100...250	2	2	AF30ZR-30-22-23	0.865

(1) Normally closed contacts included as part of the electrical interlock. Normally open auxiliaries are either integral or front-mount.  
 (2) Available in the US and Canada only.

#### Mounting dimensions mm, inches

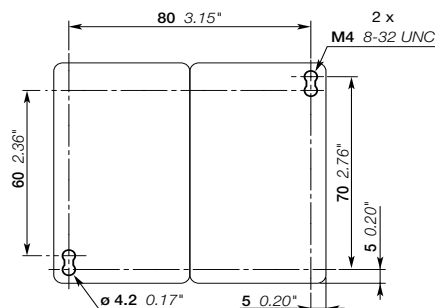

AF09ZR, AF12ZR, AF16ZR

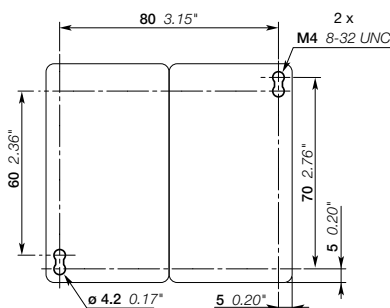

AF26ZR, AF30ZR



# AF40R ... AF96R 3-pole reversing contactors

## 30 to 60 hp at 480 V AC

### AC / DC operated



AF40M-30-22

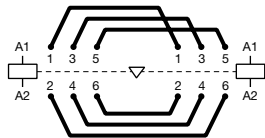

Power bus diagram

#### Description

- AF40R ... AF96R reversing contactors are mainly used for directionally controlling 3-phase motor circuits up to 690V AC. These devices include two 3-pole contactors, a mechanical interlock, side-mounted auxiliary contacts for electrical interlocking, power bus (see diagram to the left), and are assembled using fixing clips.
- **Note: for mechanically and electrically interlocked devices without power bus, replace the R in the catalog number with an M (ie. AF40R-30-22-13 becomes AF40M-30-22-13).**
- Control circuit: AC or DC operated with electronic coil interface accepting a wide control voltage
- range (e.g. 100...250 V AC and DC), only 4 control voltage ranges covering 24...500V 50/60 Hz and
- 20...500 V DC
  - can manage large control voltage variations
  - reduced panel energy consumption
  - very distinct closing and opening.
- Built-in surge suppression
- Add-on auxiliary contact blocks for front or side mounting and a wide range of accessories.

#### Ordering details

IEC		UL / CSA		Rated control circuit voltage		Auxiliary contacts fitted	Catalog number	Global reference code (2)	Weight Pkg (1 pce)										
Rated operational power	current $\theta \leq 40^\circ\text{C}$	3-phase motor rating	General use rating	Uc min. ... Uc max.															
400 V AC-3	A	AC-1	hp	A	480 V	V 50/60 Hz	V DC	2 2	AF40R-30-22-41	2.283									
					18.5						70	30	60	24...60	-				
					22	100	40	80	24...60	20...60 (1)	2 2	2 2	AF40R-30-22-11	2.283					
															48...130	48...130	2 2	AF40R-30-22-12	2.283
															100...250	100...250	2 2	AF40R-30-22-13	2.263
															250...500	250...500	2 2	AF40R-30-22-14	2.263
					30	105	50	90	24...60	20...60 (1)	2 2	2 2	AF52R-30-22-41	2.283					
															48...130	48...130	2 2	AF52R-30-22-12	2.283
															100...250	100...250	2 2	AF52R-30-22-13	2.263
															250...500	250...500	2 2	AF52R-30-22-14	2.263
					37	125	60	105	24...60	20...60 (1)	2 2	2 2	AF65R-30-22-41	2.283					
															48...130	48...130	2 2	AF65R-30-22-12	2.283
100...250	100...250	2 2	AF65R-30-22-13	2.263															
250...500	250...500	2 2	AF65R-30-22-14	2.263															
45	130	60	115	24...60	20...60 (1)	2 2	2 2	AF80R-30-22-41	2.858										
										48...130	48...130	2 2	AF80R-30-22-12	2.858					
										100...250	100...250	2 2	AF80R-30-22-13	2.758					
										250...500	250...500	2 2	AF80R-30-22-14	2.758					
45	130	60	115	24...60	20...60 (1)	2 2	2 2	AF96R-30-22-41	2.858										
										48...130	48...130	2 2	AF96R-30-22-12	2.858					
										100...250	100...250	2 2	AF96R-30-22-13	2.758					
										250...500	250...500	2 2	AF96R-30-22-14	2.758					

(1) AF..-30...-11 not suitable for direct control by PLC-output.  
 (2) Available in the US and Canada only.

#### Mounting dimensions mm, inches

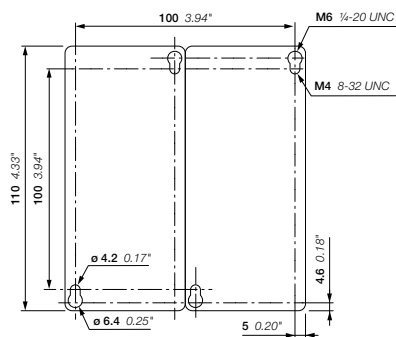

AF40R, AF52R, AF65R

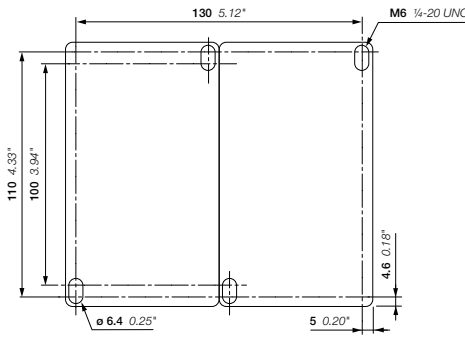

AF80R, AF96R

# AF116R ... AF140R 3-pole reversing contactors

## 75 to 100 hp at 480 V AC

### AC / DC operated

2



AF140R-30-22

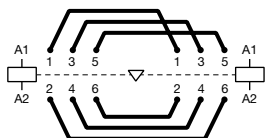

Power bus diagram

#### Description

AF116R and AF140R reversing contactors are mainly used for directionally controlling 3-phase motor circuits up to 690V AC. These devices include two 3-pole contactors, a mechanical interlock, side-mounted auxiliary contacts for electrical interlocking, power bus (see diagram to the left), and are mounted on a backplate.

**Note: for mechanically and electrically interlocked devices without power bus, replace the R in the catalog number with an M (ie. AF116R-30-22-13 becomes AF116M-30-22-13).**

- Control circuit: AC or DC operated with electronic coil interface accepting a wide control voltage range (e.g. 100...250 V AC and DC), only 4 control voltage ranges covering 24...500V 50/60 Hz and 20...500 V DC
- can manage large control voltage variations
- reduced panel energy consumption
- very distinct closing and opening
- can withstand short voltage dips and voltage sags (SEMI F47-0706 conditions of use on request).
- Built-in surge suppression
- Add-on auxiliary contact blocks for side mounting and a wide range of accessories.

#### Ordering details

IEC		UL / CSA		Rated control circuit voltage		Auxiliary contacts fitted		Catalog number	Global reference code (1)	Weight Pkg (1 pce)
Rated operational power	current $\theta \leq 40^\circ\text{C}$	3-phase motor rating	General use rating	Uc min. ... Uc max.						
400 V	AC-3	AC-1	480 V	600 V AC	V 50/60 Hz	V DC				kg (2)

#### For connection with built-in cable clamps

Rated operational power	current	3-phase motor rating	General use rating	Uc min.	Uc max.	Auxiliary contacts fitted	Uc min.	Uc max.	Catalog number	Global reference code (1)	Weight Pkg (1 pce)
55	160	75	160	24...60	20...60	2	2		AF116R-30-22-11		
				48...130	48...130	2	2		AF116R-30-22-12		
				100...250	100...250	2	2		AF116R-30-22-13		
				250...500	250...500	2	2		AF116R-30-22-14		
75	200	100	200	24...60	20...60	2	2		AF140R-30-22-11		
				48...130	48...130	2	2		AF140R-30-22-12		
				100...250	100...250	2	2		AF140R-30-22-13		
				250...500	250...500	2	2		AF140R-30-22-14		

(1) Available in the US and Canada only.

(2) Available upon request.

#### Mounting dimensions mm, inches (upon request)

# AF190R ... AF370R 3-pole reversing contactors

## 125 to 300 hp at 480 V AC

### AC / DC operated



AF205M-30-22

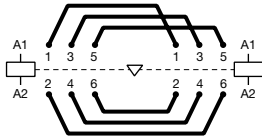

Power bus diagram

#### Description

AF190R ... AF370R reversing contactors are mainly used for directionally controlling 3-phase motor circuits up to 690V AC. These devices include two 3-pole contactors, a mechanical interlock, side-mounted auxiliary contacts for electrical interlocking, power bus (see diagram to the left), and are mounted on a backplate.

**Note: for mechanically and electrically interlocked devices without power bus, replace the R in the catalog number with an M (ie. AF190R-30-22-13 becomes AF190M-30-22-13).**

- Control circuit: AC or DC operated with electronic coil interface accepting a wide control voltage range (e.g. 100...250 V AC and DC), only 4 control voltage ranges covering 24...500V 50/60 Hz and 20...500 V DC
- can manage large control voltage variations
- reduced panel energy consumption
- very distinct closing and opening
- can withstand short voltage dips and voltage sags (SEMI F47-0706 conditions of use on request).
- Built-in surge suppression
- Add-on auxiliary contact blocks for side mounting and a wide range of accessories.

#### Ordering details

IEC		UL / CSA		Rated control circuit voltage Uc min. ... Uc max.		Auxiliary contacts fitted	Catalog number	Global reference code (2)	Weight Pkg (1 pce)
Rated operational power	current $\theta \leq 40^\circ\text{C}$	3-phase motor rating 480 V	General use rating 600 V AC						
400 V AC-3	AC-1			V 50/60 Hz	V DC				kg (3)
90	275	125	230 [250]	24...60	20...60	2 2	AF190R-30-22-11		
				48...130	48...130	2 2	AF190R-30-22-12		
				100...250	100...250	2 2	AF190R-30-22-13		
				250...500	250...500	2 2	AF190R-30-22-14		
110	350	150	250 [300]	24...60	20...60	2 2	AF205R-30-22-11		
				48...130	48...130	2 2	AF205R-30-22-12		
				100...250	100...250	2 2	AF205R-30-22-13		
				250...500	250...500	2 2	AF205R-30-22-14		
140	400	200	300 [350]	24...60	20...60	2 2	AF265R-30-22-11		
				48...130	48...130	2 2	AF265R-30-22-12		
				100...250	100...250	2 2	AF265R-30-22-13		
				250...500	250...500	2 2	AF265R-30-22-14		
160	500	250	350 [400]	24...60	20...60	2 2	AF305R-30-22-11		
				48...130	48...130	2 2	AF305R-30-22-12		
				100...250	100...250	2 2	AF305R-30-22-13		
				250...500	250...500	2 2	AF305R-30-22-14		
200	600	300	400 [520]	24...60	20...60	2 2	AF370R-30-22-11		
				48...130	48...130	2 2	AF370R-30-22-12		
				100...250	100...250	2 2	AF370R-30-22-13		
				250...500	250...500	2 2	AF370R-30-22-14		

(1) The higher ratings shown in [brackets] can be achieved through the use of LX.. Terminal extensions. Terminal extensions are included as standard for reversing contactors, but must be purchased separately for mechanically and electrically interlocked devices.  
 (2) Available in the US and Canada only.  
 (3) Available upon request.

#### Mounting dimensions mm, inches (upon request)

# AF400R ... AF750R 3-pole reversing contactors

## 350 to 600 hp at 480 V AC

### AC / DC operated

2



AF460R-30-11

#### Description

- AF400R ... AF750R reversing contactors are mainly used for directionally controlling 3-phase motor circuits up to 690V AC. These devices include two 3-pole contactors, a mechanical interlock, side-mounted auxiliary contacts for electrical interlocking, power bus (see diagram to the left), and are mounted on a back-plate.
- **Note: for mechanically and electrically interlocked devices without power bus, replace the R in the catalog number with an M (ie. AF400R-30-22-70 becomes AF400M-30-22-70).**
- Control circuit: AC or DC operated with electronic coil interface accepting a wide control voltage
- Range (e.g. 100...250 V AC and DC), only 4 control voltage ranges covering 24...500V 50/60 Hz and 20...500 V DC
  - can manage large control voltage variations
  - reduced panel energy consumption
  - very distinct closing and opening
  - can withstand short voltage dips and voltage sags (SEMI F47-0706 conditions of use on request).
- Built-in surge suppression
- Add-on auxiliary contact blocks for side mounting and a wide range of accessories.

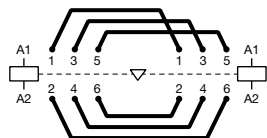

Power bus diagram

#### Ordering details

IEC Rated operational power kW	UL/CSA 3-phase motor rating 480 V General use rating 600 V AC A	UL/CSA 3-phase motor rating 480 V hp	General use rating 600 V AC A	Rated control circuit voltage Uc min. ... Uc max.		Auxiliary contacts fitted	Catalog number	Global reference code (2)	Weight Pkg (1 pce) kg (3)
				V 50/60 Hz	V DC				
200	600	350	550	-	24...60 (1)	2 2	AF400R-30-11-68		
				48...130	48...130	2 2	AF400R-30-11-69		
				100...250	100...250	2 2	AF400R-30-11-70		
				250...500	250...500	2 2	AF400R-30-11-71		
250	700	400	650	-	24...60 (1)	2 2	AF460R-30-11-68		
				48...130	48...130	2 2	AF460R-30-11-69		
				100...250	100...250	2 2	AF460R-30-11-70		
				250...500	250...500	2 2	AF460R-30-11-71		
315	800	500	750	-	24...60 (1)	2 2	AF580R-30-11-68		
				48...130	48...130	2 2	AF580R-30-11-69		
				100...250	100...250	2 2	AF580R-30-11-70		
				250...500	250...500	2 2	AF580R-30-11-71		
400	1050	600	900	-	24...60 (1)	2 2	AF750R-30-11-68		
				48...130	48...130	2 2	AF750R-30-11-69		
				100...250	100...250	2 2	AF750R-30-11-70		
				250...500	250...500	2 2	AF750R-30-11-71		

- (1) The connection polarities indicated close to the coil terminals must be respected: A1 for the positive pole and A2 for the negative pole.  
 (2) Available in the US and Canada only.  
 (3) Available upon request.

#### Control inputs

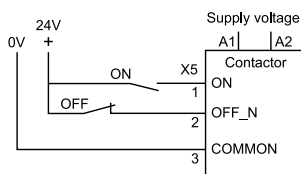

Mounting dimensions mm, inches (upon request)

# AF09N00 ... AF26N1 3-pole NEMA rated contactors

## Sizes 00 to 1

### AC / DC operated



AF09N00-30-10



AF26N1-30-00

#### Description

- AF09N00 ... AF26N1 NEMA rated contactors are mainly used for controlling 3-phase motor circuits up to 575V AC. These contactors are of the block type design with 3 main poles.
- Control circuit: AC or DC operated with electronic coil interface accepting a wide control voltage range (e.g. 100...250 V AC and DC), only 4 control voltage ranges covering 24...500V 50/60 Hz and 20...500 V DC
  - can manage large control voltage variations
  - reduced panel energy consumption
  - very distinct closing and opening.
- Built-in surge suppression
- Add-on auxiliary contact blocks for front or side mounting and a wide range of accessories.

#### Ordering details

NEMA				Rated control circuit voltage		Auxiliary contacts fitted	Catalog number	Global reference code (2)	Weight Pkg (1 pce)
Size	Continuous current	3-phase motor rating		Uc min. ... Uc max.					
	A	230 V hp	460/575V hp	V 50/60 Hz	V DC				kg
00	9	1.5	25	24...60	-	(1)	1 0	AF09N00-30-10-41	0.270
				48...130	48...130	1 0	AF09N00-30-01-41	0.270	
				100...250	100...250	1 0	AF09N00-30-10-12	0.270	
				250...500	250...500	1 0	AF09N00-30-01-12	0.270	
				250...500	250...500	1 0	AF09N00-30-10-13	0.270	
0	18	3	5	24...60	-	(1)	0 1	AF09N00-30-01-14	0.310
				48...130	48...130	1 0	AF12N0-30-10-41	0.270	
				100...250	100...250	1 0	AF12N0-30-10-12	0.270	
				250...500	250...500	1 0	AF12N0-30-01-12	0.270	
				250...500	250...500	1 0	AF12N0-30-10-13	0.270	
1	27	7.5	10	24...60	-	(1)	0 0	AF12N0-30-10-14	0.310
				48...130	48...130	0 0	AF26N1-30-00-41	0.310	
				100...250	100...250	0 0	AF26N1-30-00-12	0.310	
				250...500	250...500	0 0	AF26N1-30-00-13	0.310	
				250...500	250...500	0 0	AF26N1-30-00-14	0.350	

(1) For 24...60 V 50/60 Hz - 20...60 V DC, use AF.-30-.-11 (see voltage code table). AF.-30-.-11 not suitable for direct control by PLC-output.

(2) Available in the US and Canada only.

#### Main dimensions mm, inches

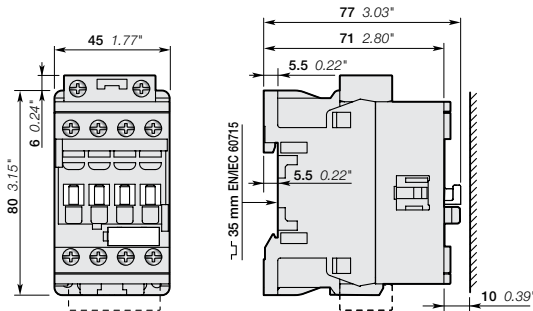

AF09N00, AF12N0

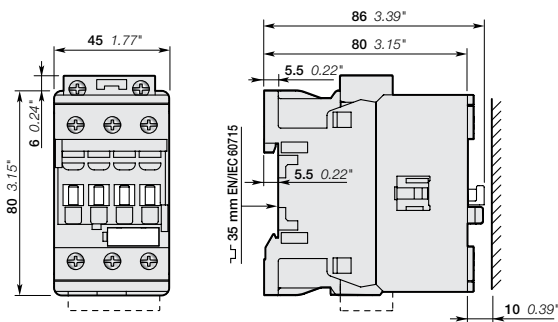

AF26N1

# AF09N00Z ... AF26N1Z 3-pole NEMA rated contactors

## Sizes 00 to 1

### AC / DC operated - low consumption

2



AF09N00Z-30-10



AF26N1Z-30-00

#### Description

- AF09N00 ... AF26N1 NEMA rated contactors are mainly used for controlling 3-phase motor circuits up to 575V AC. These contactors are of the block type design with 3 main poles.
- Control circuit: AC or DC operated with electronic coil interface accepting a wide control voltage range (e.g. 100...250 V AC and DC), only 4 control voltage ranges covering 24...500V 50/60 Hz and 20...500 V DC
  - can manage large control voltage variations
  - reduced panel energy consumption
  - very distinct closing and opening.
- Built-in surge suppression
- Add-on auxiliary contact blocks for front or side mounting and a wide range of accessories.

#### Ordering details

NEMA				Rated control circuit voltage		Auxiliary contacts fitted	Catalog number	Global reference code (2)	Weight Pkg (1 pce)
Size	Continuous current	3-phase motor rating		Uc min. ... Uc max.					
	A	230 V hp	460/575V hp	V 50/60 Hz	V DC			kg	
0	9	1.5	25	-	12...20 (1)	1 0	AF09N00Z-30-10-20	0.310	
						0 1	AF09N00Z-30-01-20	0.310	
				24...60	20...60	1 0	AF09N00Z-30-10-21	0.310	
						0 1	AF09N00Z-30-01-21	0.310	
				48...130	48...130	1 0	AF09N00Z-30-10-22	0.310	
						0 1	AF09N00Z-30-01-22	0.310	
0	18	3	5	-	12...20 (1)	1 0	AF12N0Z-30-10-20	0.310	
						0 1	AF12N0Z-30-01-20	0.310	
				24...60	20...60	1 0	AF12N0Z-30-10-21	0.310	
						0 1	AF12N0Z-30-01-21	0.310	
				48...130	48...130	1 0	AF12N0Z-30-10-22	0.310	
						0 1	AF12N0Z-30-01-22	0.310	
1	27	7.5	10	-	12...20 (1)	0 0	AF26N1Z-30-00-20	0.350	
						0 0	AF26N1Z-30-00-21	0.350	
				24...60	20...60	0 0	AF26N1Z-30-00-22	0.350	
						0 0	AF26N1Z-30-00-23	0.350	
				48...130	48...130	0 0	AF26N1Z-30-00-22	0.350	
						0 0	AF26N1Z-30-00-23	0.350	

(1) Only AF.Z contactors with DC control voltage 12...20 V DC need to respect the connection polarities indicated close to the coil terminals: A1+ for the positive pole and A2- for the negative pole.

(2) Available in the US and Canada only.

#### Main dimensions mm, inches

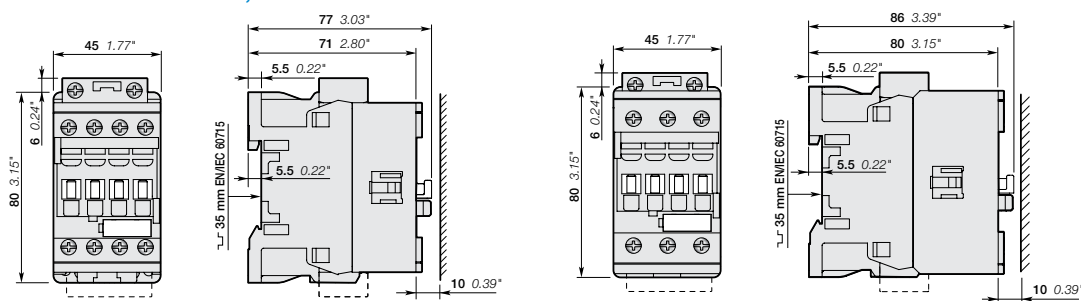

AF09N00Z, AF12N0Z

AF26N1Z

# AF40N2 & AF80N3 3-pole NEMA rated contactors

## Sizes 2 & 3

### AC / DC operated with 1 N.O. + 1 N.C. auxiliary contacts



AF40N2-30-11



AF80N3-30-11

#### Description

- AF40N2 and AF80N3 NEMA rated contactors are mainly used for controlling 3-phase motor circuits up to 575V AC. These contactors are of the block type design with 3 main poles.
- Control circuit: AC or DC operated with electronic coil interface accepting a wide control voltage range (e.g. 100...250 V AC and DC), only 4 control voltage ranges covering 24...500V 50/60 Hz and 20...500 V DC
- can manage large control voltage variations
- reduced panel energy consumption
- very distinct closing and opening.
- Built-in surge suppression
- Add-on auxiliary contact blocks for front or side mounting and a wide range of accessories.

#### Ordering details

NEMA				Rated control circuit voltage		Auxiliary contacts fitted	Catalog number	Global reference code (2)	Weight Pkg (1 pce)
Size	Continuous current	3-phase motor rating		Uc min. ... Uc max.					
	A	230 V	460/575V	V 50/60 Hz	V DC				kg
2	45	15	25	24...60	-	1 1	AF40N2-30-11-41		1,010
				24...60	20...60 (1)	1 1	AF40N2-30-11-11		1,010
				48...130	48...130	1 1	AF40N2-30-11-12		1,010
				100...250	100...250	1 1	AF40N2-30-11-13		1,000
				250...500	250...500	1 1	AF40N2-30-11-14		1,000
3	90	30	50	24...60	-	1 1	AF80N3-30-11-41		1,260
				24...60	20...60 (1)	1 1	AF80N3-30-11-11		1,260
				48...130	48...130	1 1	AF80N3-30-11-12		1,260
				100...250	100...250	1 1	AF80N3-30-11-13		1,210
				250...500	250...500	1 1	AF80N3-30-11-14		1,210

(1) AF.-30-...-11 not suitable for direct control by PLC-output.  
 (2) Available in the US and Canada only.

#### Main dimensions mm, inches

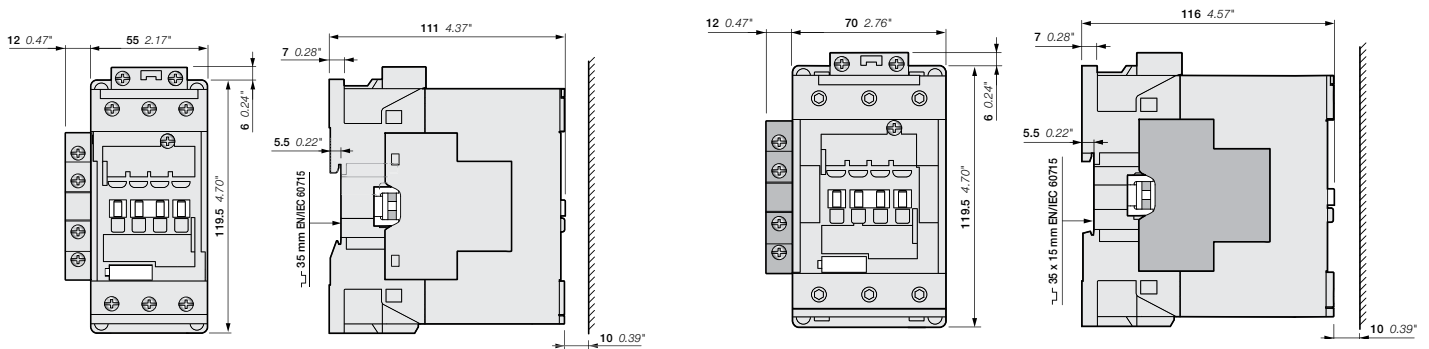

AF40N2

AF80N3

# AF140N4 & AF265N5 3-pole NEMA rated contactors

## Sizes 4 & 5

### AC / DC operated with 1 N.O. + 1 N.C. auxiliary contacts

2



AF140N4-30-11



AF140N4-30-11B



AF265N5-30-11

#### Description

AF140N4 and AF265N5 NEMA rated contactors are mainly used for controlling 3-phase motor circuits up to 575V AC. These contactors are of the block type design with 3 main poles.

- Control circuit: AC or DC operated with electronic coil interface accepting a wide control voltage range (e.g. 100...250 V AC and DC), only 4 control voltage ranges covering 24...500V 50/60 Hz and 20...500 V DC
- can manage large control voltage variations
- reduced panel energy consumption
- very distinct closing and opening
- can withstand short voltage dips and voltage sags (SEMI F47-0706 conditions of use on request).
- Built-in surge suppression
- Add-on auxiliary contact blocks for side mounting and a wide range of accessories.

#### Ordering details

NEMA		3-phase motor rating		Rated control circuit voltage		Auxiliary contacts fitted	Catalog number	Global reference code (1)	Weight Pkg (1 pce)
Size	Continuous current	230 V	460/575V	Uc min. ... Uc max.					
	A	hp	hp	V 50/60 Hz	V DC				kg
<b>For connection with built-in cable clamps</b>									
4	135	50	100	24...60	20...60	1 1	AF140N4-30-11-11		1.750
				48...130	48...130	1 1	AF140N4-30-11-12		1.750
				100...250	100...250	1 1	AF140N4-30-11-13		1.750
				250...500	250...500	1 1	AF140N4-30-11-14		1.750
<b>With bar connections</b>									
4	135	50	100	24...60	20...60	1 1	AF140N4-30-11B-11		1.500
				48...130	48...130	1 1	AF140N4-30-11B-12		1.500
				100...250	100...250	1 1	AF140N4-30-11B-13		1.500
				250...500	250...500	1 1	AF140N4-30-11B-14		1.500
5	270	100	200	24...60	20...60	1 1	AF265N5-30-11-11		4.640
				48...130	48...130	1 1	AF265N5-30-11-12		4.640
				100...250	100...250	1 1	AF265N5-30-11-13		4.640
				250...500	250...500	1 1	AF265N5-30-11-14		4.640

(1) Available in the US and Canada only.

#### Main dimensions mm, inches

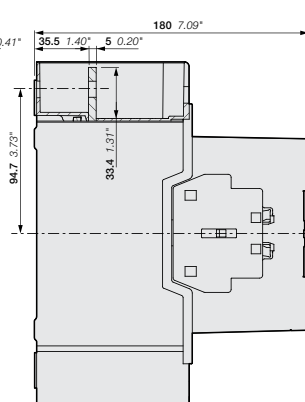
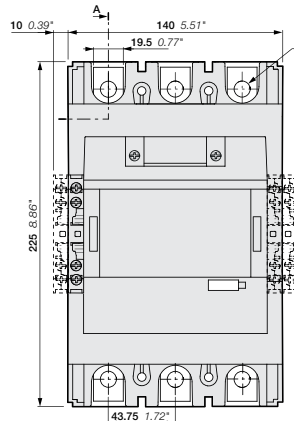
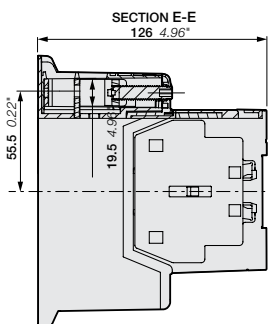
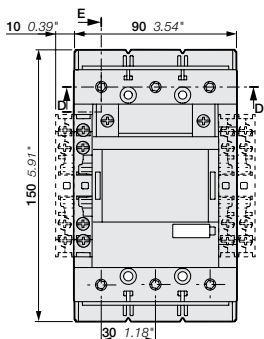

AF140N4

AF265N5



# AF460N6 & AF750N7 3-pole NEMA rated contactors

## Sizes 6 & 7

### AC / DC operated with 1 N.O. + 1 N.C. auxiliary contacts



AF460N6-30-11



AF750N7-30-11

#### Description

AF460N6 and AF750N7 NEMA rated contactors are mainly used for controlling 3-phase motor circuits up to 575V AC. These contactors are of the block type design with 3 main poles.

- Control circuit: AC or DC operated with electronic coil interface accepting a wide control voltage range (e.g. 100...250 V AC and DC), only 4 coils to cover control voltages between 48...500 V 50/60 Hz and 24...500 V DC
- can manage large control voltage variations
- reduced panel energy consumption
- very distinct closing and opening
- can withstand short voltage dips and voltage sags (SEMI F47-0706 conditions of use on request).
- Built-in surge suppression
- Add-on auxiliary contact blocks for side mounting and a wide range of accessories.

#### Ordering details

NEMA		3-phase motor rating		Rated control circuit voltage		Auxiliary contacts fitted		Catalog number	Global reference code (2)	Weight
Size	Continuous current	230 V	460/575V	Uc min. ... Uc max.						Pkg (1 pce)
	A	hp	hp	V 50/60 Hz	V DC					kg
6	540	200	400	-	24...60 (1)	1	1	AF460N6-3011-68		12.000
				48...130	48...130	1	1	AF460N6-3011-69		12.000
				100...250	100...250	1	1	AF460N6-3011-70		12.000
				250...500	250...500	1	1	AF460N6-3011-71		12.000
7	810	300	600	-	24...60 (1)	1	1	AF750N7-3011-68		15.000
				48...130	48...130	1	1	AF750N7-3011-69		15.000
				100...250	100...250	1	1	AF750N7-3011-70		15.000
				250...500	250...500	1	1	AF750N7-3011-71		15.000

- (1) The connection polarities indicated close to the coil terminals must be respected: A1 for the positive pole and A2 for the negative.  
 (2) Available in the US and Canada only.

#### Control inputs

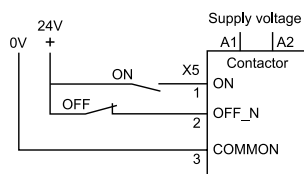

#### Main dimensions mm, inches

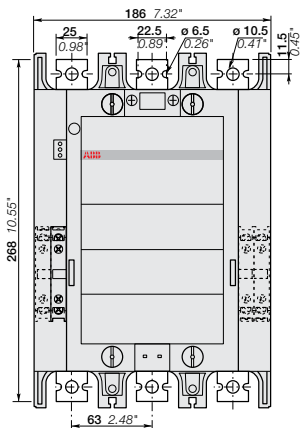

AF460N6

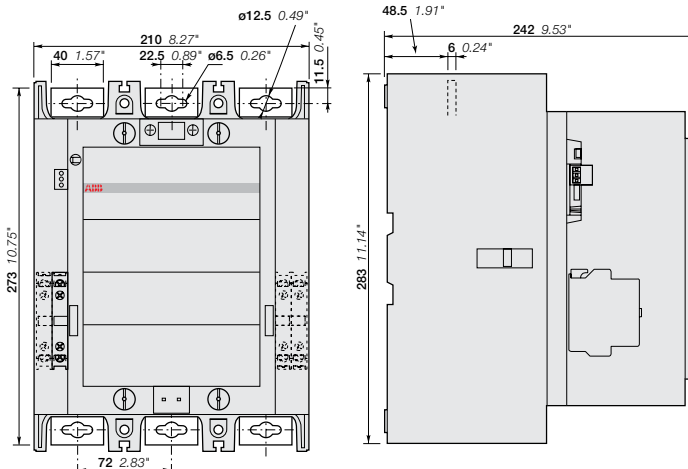
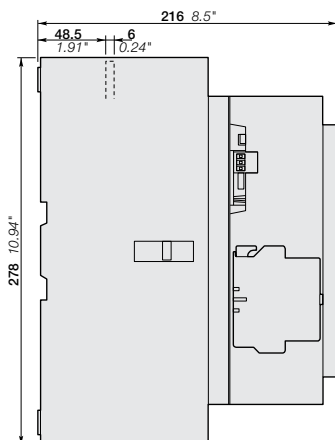

AF750N7

# AF1650N8 3-pole NEMA rated contactor

## Size 8

### AC / DC operated with 1 N.O. + 1 N.C. auxiliary contacts

2



AF1650N8-30-11

#### Description

AF1650N8 NEMA rated contactor is mainly used for controlling 3-phase motor circuits up to 575V AC. This contactor is of the block type design with 3 main poles.

- Control circuit: AC or DC operated with electronic coil interface accepting a wide control voltage range, only 1 coil to cover control voltages between between 100...250 V 50/60 Hz and 100...250 V DC
- can manage large control voltage variations
- reduced panel energy consumption
- very distinct closing and opening
- can withstand short voltage dips and voltage sags (SEMI F47-0706 conditions of use on request).
- Built-in surge suppression
- Add-on auxiliary contact blocks for side mounting and a wide range of accessories.

#### Ordering details

NEMA		3-phase motor rating		Rated control circuit voltage		Auxiliary contacts fitted		Global reference code (1)	Weight
Size	Continuous current	230 V	460/575V	Uc min. ... Uc max.					Pkg (1 pce)
	A	hp	hp	V 50/60 Hz	V DC				kg
8	1215	450	900	100...250	100...250	1	1	AF1650N83011-70	35.000

(1) Available in the US and Canada only.

#### Control inputs

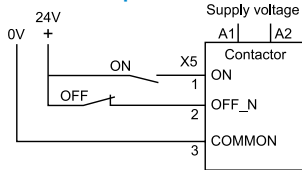

#### AF1650N8

A	392 mm / 15.43"
B	47 mm / 1.85"
C	10 mm / 0.39"
D	3 mm / 0.12"

#### Main dimensions mm, inches

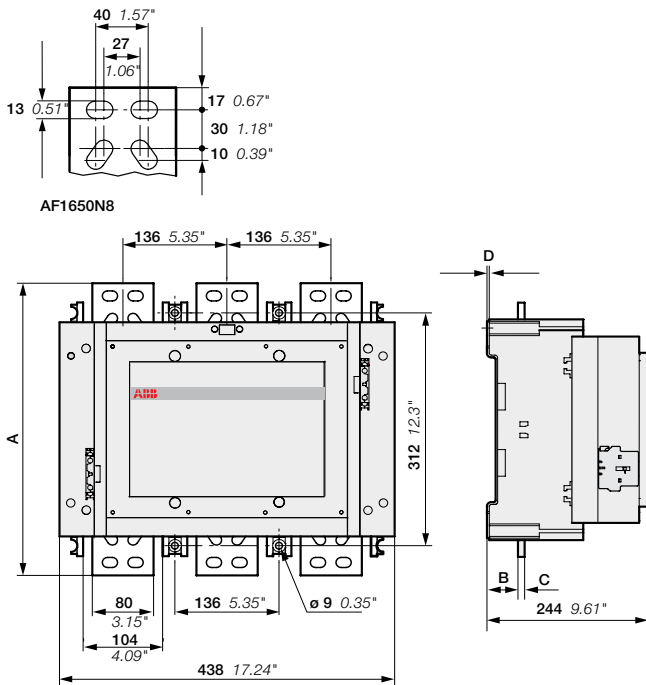

AF1650N8

# AF09N00R ... AF26N1R 3-pole NEMA rated reversing contactors

## Sizes 00 to 1

### AC / DC operated



AF09N00R-3022

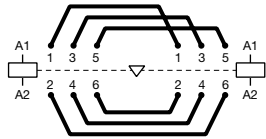

Power bus diagram

### Description

AF09N00R ... AF26N1R NEMA rated reversing contactors are mainly used for directionally controlling 3-phase motor circuits up to 575V AC. These devices include two 3-pole contactors, a mechanical and electrical interlock, power bus (see diagram to the left), and are assembled using fixing clips.

**Note: for mechanically and electrically interlocked devices without power bus, replace the R in the catalog number with an M (ie. AF09N00R-3022-13 becomes AF09N00M-3022-13).**

- control circuit: AC or DC operated with electronic coil interface accepting a wide control voltage range (e.g. 100...250 V AC and DC), only 4 control voltage ranges covering 24...500V 50/60 Hz and 20...500 V DC
  - can manage large control voltage variations
  - reduced panel energy consumption
  - very distinct closing and opening
- built-in surge suppression
- add-on auxiliary contact blocks for front or side mounting and a wide range of accessories

### Ordering details

NEMA Size	Continuous current	3-phase motor rating		Rated control circuit voltage		Auxiliary contacts fitted (2)	Catalog number	Global reference code (3)	Weight Pkg (1 pce)
		230V	460/575	Uc min. ... Uc max.					
	A	hp	hp	V 50/60 Hz	V DC				kg
00	9	1.5	2	24...60	- (1)	2 2	AF09N00R-3022-41		0.622
				48...130	48...130	2 2	AF09N00R-3022-12		0.622
				100...250	100...250	2 2	AF09N00R-3022-13		0.622
				250...500	250...500	2 2	AF09N00R-3022-14		0.702
0	18	3	5	24...60	- (1)	2 2	AF12N0R-3022-41		0.622
				48...130	48...130	2 2	AF12N0R-3022-12		0.622
				100...250	100...250	2 2	AF12N0R-3022-13		0.622
				250...500	250...500	2 2	AF12N0R-3022-14		0.702
1	27	7.5	10	24...60	- (1)	0 2	AF26N1R-3002-41		0.757
				48...130	48...130	2 2	AF26N1R-3022-41		0.785
				48...130	48...130	0 2	AF26N1R-3002-12		0.757
				48...130	48...130	2 2	AF26N1R-3022-12		0.785
				100...250	100...250	0 2	AF26N1R-3002-13		0.757
				100...250	100...250	2 2	AF26N1R-3022-13		0.785
250...500	250...500	0 2	AF26N1R-3002-14		0.837				
250...500	250...500	2 2	AF26N1R-3022-14		0.865				

(1) For 24...60 V 50/60 Hz - 20...60 V DC, use AF.-30-.-11 (see voltage code table). AF.-30-.-11 not suitable for direct control by PLC-output.  
 (2) Normally closed contacts included as part of the electrical interlock. Normally open auxiliaries are either integral or front-mount.  
 (3) Available in the US and Canada only.

### Mounting dimensions mm, inches

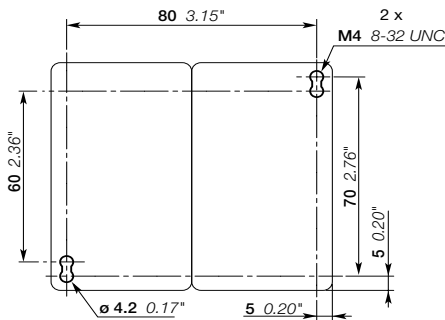

AF09N00R, AF12N0R

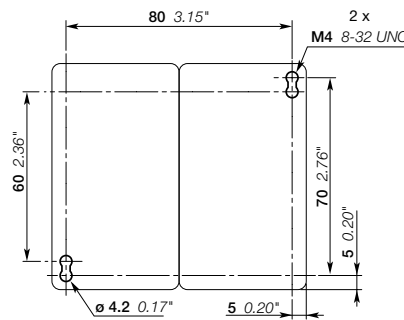

AF26N1R

# AF09N00ZR ... AF26N1ZR 3-pole NEMA rated reversing contactors

## Sizes 00 to 1

### AC / DC operated - low consumption

2



AF09N00ZR-30-22

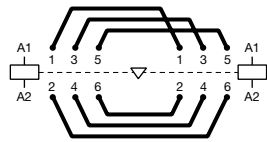

Power bus diagram

#### Description

AF09N00ZR ... AF26N1ZR NEMA rated reversing contactors are mainly used for directionally controlling 3-phase motor circuits up to 575V AC. These devices include two 3-pole contactors, a mechanical and electrical interlock, power bus (see diagram to the left), and are assembled using fixing clips.

**Note: for mechanically and electrically interlocked devices without power bus, replace the R in the catalog number with an M (ie. AF09N00ZR-3022-13 becomes AF09N00ZM-3022-13).**

- control circuit: AC or DC operated with electronic coil interface accepting a wide control voltage range (e.g. 100...250 V AC and DC), only 4 control voltage ranges covering 24...250 V 50/60 Hz and 20...250 V DC
- can manage large control voltage variations
- allow direct control by PLC-output  $\geq 24$  V DC 500 mA
- reduced panel energy consumption
- very distinct closing and opening
- can withstand short voltage dips and voltage sags (SEMI F47-0706 conditions of use on request)
- built-in surge suppression
- add-on auxiliary contact blocks for front or side mounting and a wide range of accessories

#### Ordering details

NEMA Size	Continuous current	3-phase motor rating		Rated control circuit voltage		Auxiliary contacts fitted (2)	Catalog number	Global reference code (3)	Weight Pkg (1 pce)
		230V	460/575	Uc min. ... Uc max.	Uc min. ... Uc max.				
	A	hp	hp	V 50/60 Hz	V DC				kg
00	9	1.5	2	24...60	20...60	2 2	AF09N00ZR-3022-21		0.702
				48...130	48...130	2 2	AF09N00ZR-3022-22		0.702
				100...250	100...250	2 2	AF09N00ZR-3022-23		0.702
0	18	3	5	24...60	20...60	2 2	AF12N0ZR-3022-21		0.702
				48...130	48...130	2 2	AF12N0ZR-3022-22		0.702
				100...250	100...250	2 2	AF12N0ZR-3022-23		0.702
1	27	7.5	10	24...60	20...60	0 2	AF26N1ZR-3002-21		0.837
				48...130	48...130	2 2	AF26N1ZR-3022-21		0.865
				48...130	48...130	0 2	AF26N1ZR-3002-22		0.837
				48...130	48...130	2 2	AF26N1ZR-3022-22		0.865
				100...250	100...250	0 2	AF26N1ZR-3002-23		0.837
				100...250	100...250	2 2	AF26N1ZR-3022-23		0.865

(1) Normally closed contacts included as part of the electrical interlock. Normally open auxiliaries are either integral or front-mount.

(2) Available in the US and Canada only.

#### Mounting dimensions mm, inches

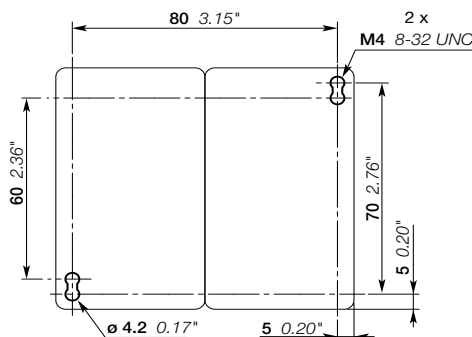

AF09N00ZR, AF12N0ZR

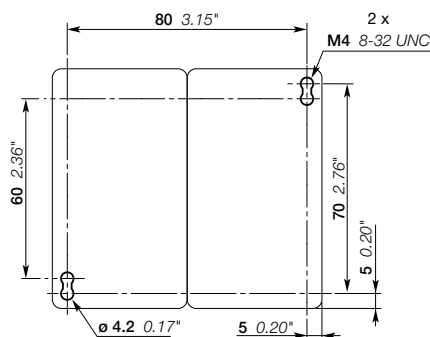

AF26N1ZR

# AF40N2R & AF80N3R 3-pole NEMA rated reversing contactors

## Sizes 2 & 3

### AC / DC operated



AF40N2M-3022

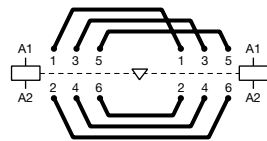

Power bus diagram

#### Description

AF40N2R and AF80N3R NEMA rated reversing contactors are mainly used for directionally controlling 3-phase motor circuits up to 575V AC. These devices include two 3-pole contactors, a mechanical interlock, side-mounted auxiliary contacts for electrical interlocking, power bus (see diagram to the left), and are assembled using fixing clips.

**Note: for mechanically and electrically interlocked devices without power bus, replace the R in the catalog number with an M (ie. AF40N2R-30-22-13 becomes AF40N2M-30-22-13).**

- control circuit: AC or DC operated with electronic coil interface accepting a wide control voltage range (e.g. 100...250 V AC and DC), only 4 control voltage ranges covering 24...500V 50/60 Hz and 20...500 V DC
- can manage large control voltage variations
- reduced panel energy consumption
- very distinct closing and opening
- built-in surge suppression
- add-on auxiliary contact blocks for front or side mounting and a wide range of accessories

#### Ordering details

NEMA Size	Continuous current	3-phase motor rating		Rated control circuit voltage		Auxiliary contacts fitted (2)	Catalog number	Global reference code (3)	Weight Pkg (1 pce)
		230V	460/575	Uc min. ... Uc max.					
	A	hp	hp	V 50/60 Hz	V DC				kg
2	45	15	25	24...60	-	2 2	AF40N2R-3022-41		2.283
				24...60	20...60 (1)	2 2	AF40N2R-3022-11		2.283
				48...130	48...130	2 2	AF40N2R-3022-12		2.283
				100...250	100...250	2 2	AF40N2R-3022-13		2.263
				250...500	250...500	2 2	AF40N2R-3022-14		2.263
3	90	30	50	24...60	-	2 2	AF80N3R-3022-41		2.858
				24...60	20...60 (1)	2 2	AF80N3R-3022-11		2.858
				48...130	48...130	2 2	AF80N3R-3022-12		2.858
				100...250	100...250	2 2	AF80N3R-3022-13		2.758
				250...500	250...500	2 2	AF80N3R-3022-14		2.758

(1) AF.-30...-11 not suitable for direct control by PLC-output.  
 (2) Normally closed contacts included as part of the electrical interlock. Normally open auxiliaries are either integral or front-mount.  
 (3) Available in the US and Canada only.

#### Mounting dimensions mm, inches

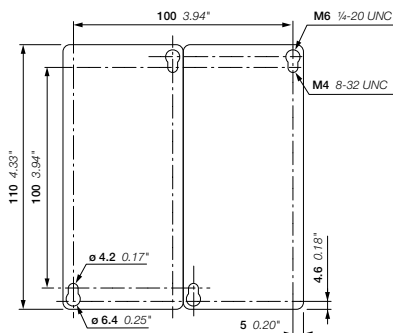

AF40N2R

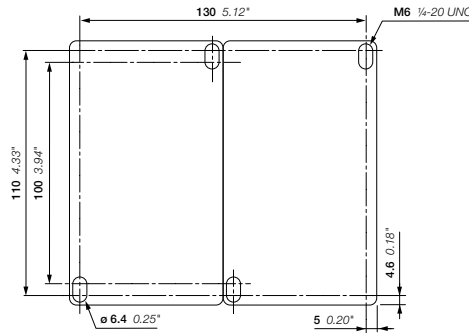

AF80N3R

# AF140N4R & AF265N5R 3-pole NEMA rated reversing contactors

## Sizes 4 & 5

### AC / DC operated

2



AF140N4R-30-22

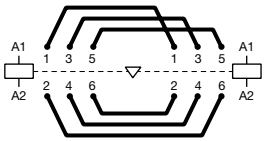

Power bus diagram

#### Description

AF140N4 and AF265N5 NEMA rated contactors are mainly used for directionally controlling 3-phase motor circuits up to 575V AC. These devices include two 3-pole contactors, a mechanical interlock, side-mounted auxiliary contacts for electrical interlocking, power bus (see diagram to the left), and are mounted on a back-plate.

**Note: for mechanically and electrically interlocked devices without power bus, replace the R in the catalog number with an M (ie. AF140N4R-30-22-13 becomes AF140N4M-30-22-13).**

- control circuit: AC or DC operated with electronic coil interface accepting a wide control voltage range (e.g. 100...250 V AC and DC), only 4 control voltage ranges covering 24...500V 50/60 Hz and 20...500 V DC
- can manage large control voltage variations
- reduced panel energy consumption
- very distinct closing and opening
- can withstand short voltage dips and voltage sags (SEMI F47-0706 conditions of use on request).
- built-in surge suppression
- add-on auxiliary contact blocks for side mounting and a wide range of accessories

#### Ordering details

NEMA Size	Continuous current	3-phase motor rating		Rated control circuit voltage Uc min. ... Uc max.		Auxiliary contacts fitted (2)	Catalog number	Global reference code (1)	Weight Pkg (1 pce) kg (2)
		230V	460/575	V 50/60 Hz	V DC				
4	135	50	100	24...60	20...60	2 2	AF140N4R-3022-11		
				48...130	48...130	2 2	AF140N4R-3022-12		
				100...250	100...250	2 2	AF140N4R-3022-13		
				250...500	250...500	2 2	AF140N4R-3022-14		
5	270	100	200	24...60	20...60	2 2	AF265N5R-3022-11		
				48...130	48...130	2 2	AF265N5R-3022-12		
				100...250	100...250	2 2	AF265N5R-3022-13		
				250...500	250...500	2 2	AF265N5R-3022-14		

(1) Available in the US and Canada only.

(2) Available upon request.

Mounting dimensions mm, inches (upon request)

# AF460N6 & AF750N7 3-pole NEMA rated reversing contactors

## Sizes 6 & 7

### AC / DC operated



AF460N6R-11

#### Description

AF460N6 and AF750N7 NEMA rated contactors are mainly used for directionally controlling 3-phase motor circuits up to 575V AC. These devices include two 3-pole contactors, a mechanical interlock, side-mounted auxiliary contacts for electrical interlocking, power bus (see diagram to the left), and are mounted on a back-plate.

**Note: for mechanically and electrically interlocked devices without power bus, replace the R in the catalog number with an M (ie. AF460N6R-11-70 becomes AF460N6M-11-70).**

- control circuit: AC or DC operated with electronic coil interface accepting a wide control voltage range (e.g. 100...250 V AC and DC), only 4 coils to cover control voltages between 48...500 V 50/60 Hz and 24...500 V DC
- can manage large control voltage variations
- reduced panel energy consumption
- very distinct closing and opening
- can withstand short voltage dips and voltage sags (SEMI F47-0706 conditions of use on request)
- built-in surge suppression
- add-on auxiliary contact blocks for front or side mounting and a wide range of accessories

#### Ordering details

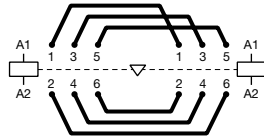

Power bus diagram

NEMA Size	Continuous current	3-phase motor rating		Rated control circuit voltage		Auxiliary contacts fitted (2)	Catalog number	Global reference code (2)	Weight
		230V	460/575	Uc min. ... Uc max.					
	A	hp	hp	V 50/60 Hz	V DC				kg (3)
6	540	200	400	-	24...60 (1)	2 2	AF460N6R-11-68		
				48...130	48...130	2 2	AF460N6R-11-69		
				100...250	100...250	2 2	AF460N6R-11-70		
				250...500	250...500	2 2	AF460N6R-11-71		
7	810	300	600	-	24...60 (1)	2 2	AF750N7R-11-68		
				48...130	48...130	2 2	AF750N7R-11-69		
				100...250	100...250	2 2	AF750N7R-11-70		
				250...500	250...500	2 2	AF750N7R-11-71		

(1) The connection polarities indicated close to the coil terminals must be respected: A1 for the positive pole and A2 for the negative.

(2) Available in the US and Canada only.

(3) Available upon request.

#### Control inputs

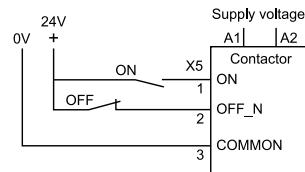

Mounting dimensions mm, inches (upon request)

# AF09 ... AF38 4-pole contactors

## 25 to 55 A general use

### AC / DC operated

2



AF09-40-00



AF26-40-00

#### Description

AF09 ... AF38 4-pole contactors are mainly used for controlling non-inductive or slightly inductive loads (i.e. resistance furnaces...) and generally for controlling power circuits up to 690 V AC and 440 V DC. These contactors are of the block type design with 4 main poles.

- control circuit: AC or DC operated with electronic coil interface accepting a wide control voltage range (e.g. 100...250 V AC and DC), only 4 control voltage ranges covering 24...500 V 50/60 Hz and 20...500 V DC
- can manage large control voltage variations
- reduced panel energy consumption
- very distinct closing and opening
- built-in surge suppression
- add-on auxiliary contact blocks for front or side mounting and a wide range of accessories

#### Ordering details

IEC	UL/CSA	Rated control circuit voltage		Auxiliary contacts fitted	Catalog number	Global reference code	Weight	
		Uc min. ... Uc max.						
Rated operational current $\theta \leq 40^\circ\text{C}$ AC-1	General use rating 600 V AC	V 50/60 Hz	V DC				Pkg (1 pce) kg	
<b>4 N.O. main poles</b>								
25	25	24...60	-	(1)	0 0	AF09-40-00-41	1SBL137201R4100	0.270
		48...130	48...130		0 0	AF09-40-00-12	1SBL137201R1200	0.270
		100...250	100...250		0 0	AF09-40-00-13	1SBL137201R1300	0.270
		250...500	250...500		0 0	AF09-40-00-14	1SBL137201R1400	0.310
30	30	24...60	-	(1)	0 0	AF16-40-00-41	1SBL177201R4100	0.270
		48...130	48...130		0 0	AF16-40-00-12	1SBL177201R1200	0.270
		100...250	100...250		0 0	AF16-40-00-13	1SBL177201R1300	0.270
		250...500	250...500		0 0	AF16-40-00-14	1SBL177201R1400	0.310
45	45	24...60	-	(1)	0 0	AF26-40-00-41	1SBL237201R4100	0.360
		48...130	48...130		0 0	AF26-40-00-12	1SBL237201R1200	0.360
		100...250	100...250		0 0	AF26-40-00-13	1SBL237201R1300	0.360
		250...500	250...500		0 0	AF26-40-00-14	1SBL237201R1400	0.400
55	55	24...60	-	(1)	0 0	AF38-40-00-41	1SBL297201R4100	0.360
		48...130	48...130		0 0	AF38-40-00-12	1SBL297201R1200	0.360
		100...250	100...250		0 0	AF38-40-00-13	1SBL297201R1300	0.360
		250...500	250...500		0 0	AF38-40-00-14	1SBL297201R1400	0.400
<b>2 N.O. + 2 N.C. main poles</b>								
25	25	24...60	-	(1)	0 0	AF09-22-00-41	1SBL137501R4100	0.270
		48...130	48...130		0 0	AF09-22-00-12	1SBL137501R1200	0.270
		100...250	100...250		0 0	AF09-22-00-13	1SBL137501R1300	0.270
		250...500	250...500		0 0	AF09-22-00-14	1SBL137501R1400	0.310
30	30	24...60	-	(1)	0 0	AF16-22-00-41	1SBL177501R4100	0.270
		48...130	48...130		0 0	AF16-22-00-12	1SBL177501R1200	0.270
		100...250	100...250		0 0	AF16-22-00-13	1SBL177501R1300	0.270
		250...500	250...500		0 0	AF16-22-00-14	1SBL177501R1400	0.310
45	45	24...60	-	(1)	0 0	AF26-22-00-41	1SBL237501R4100	0.360
		48...130	48...130		0 0	AF26-22-00-12	1SBL237501R1200	0.360
		100...250	100...250		0 0	AF26-22-00-13	1SBL237501R1300	0.360
		250...500	250...500		0 0	AF26-22-00-14	1SBL237501R1400	0.400
55	55	24...60	-	(1)	0 0	AF38-22-00-41	1SBL297501R4100	0.360
		48...130	48...130		0 0	AF38-22-00-12	1SBL297501R1200	0.360
		100...250	100...250		0 0	AF38-22-00-13	1SBL297501R1300	0.360
		250...500	250...500		0 0	AF38-22-00-14	1SBL297501R1400	0.400

(1) For 24...60 V 50/60 Hz - 20...60 V DC, use AF.-...-11 (see voltage code table). AF.-...-11 not suitable for direct control by PLC-output.

#### Main dimensions mm, inches

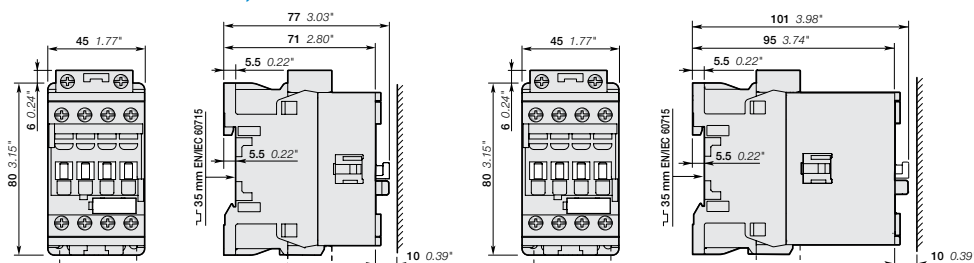

AF09, AF16

AF26, AF38



# AF09Z ... AF38Z 4-pole contactors

## 25 to 55 A general use

### AC / DC operated - low consumption



AF09Z-40-00



AF26Z-40-00

#### Description

AF09Z ... AF38Z 4-pole contactors are mainly used for controlling non-inductive or slightly inductive loads (i.e. resistance furnaces...) and generally for controlling power circuits up to 690 V AC and 440 V DC. These contactors are of the block type design with 4 main poles.

- control circuit: AC or DC operated with electronic coil interface accepting a wide control voltage range (e.g. 100...250 V AC and DC), only 4 control voltage ranges covering 24...250 V 50/60 Hz and 12...250 V DC
- can manage large control voltage variations
- allow direct control by PLC-output  $\geq 24$  V DC 500 mA
- reduced panel energy consumption
- very distinct closing and opening
- can withstand short voltage dips and voltage sags (SEMI F47-0706 conditions of use on request).
- built-in surge suppression
- add-on auxiliary contact blocks for front or side mounting and a wide range of accessories.

#### Ordering details

IEC Rated operational current $\leq 40$ °C AC-1 A	UL/CSA General use rating 600 V AC A	Rated control circuit voltage Uc min. ... Uc max.		Auxiliary contacts fitted 	Catalog number	Global reference code	Weight Pkg (1 pce) kg
		V 50/60 Hz	V DC				
<b>4 N.O. main poles</b>							
25	25	-	12...20	0 0	AF09Z-40-00-20	1SBL136201R2000	0.310
		24...60	20...60	0 0	AF09Z-40-00-21	1SBL136201R2100	0.310
		48...130	48...130	0 0	AF09Z-40-00-22	1SBL136201R2200	0.310
		100...250	100...250	0 0	AF09Z-40-00-23	1SBL136201R2300	0.310
30	30	-	12...20	0 0	AF16Z-40-00-20	1SBL176201R2000	0.310
		24...60	20...60	0 0	AF16Z-40-00-21	1SBL176201R2100	0.310
		48...130	48...130	0 0	AF16Z-40-00-22	1SBL176201R2200	0.310
		100...250	100...250	0 0	AF16Z-40-00-23	1SBL176201R2300	0.310
45	45	-	12...20	0 0	AF26Z-40-00-20	1SBL236201R2000	0.400
		24...60	20...60	0 0	AF26Z-40-00-21	1SBL236201R2100	0.400
		48...130	48...130	0 0	AF26Z-40-00-22	1SBL236201R2200	0.400
		100...250	100...250	0 0	AF26Z-40-00-23	1SBL236201R2300	0.400
55	55	-	12...20	0 0	AF38Z-40-00-20	1SBL296201R2000	0.400
		24...60	20...60	0 0	AF38Z-40-00-21	1SBL296201R2100	0.400
		48...130	48...130	0 0	AF38Z-40-00-22	1SBL296201R2200	0.400
		100...250	100...250	0 0	AF38Z-40-00-23	1SBL296201R2300	0.400
<b>2 N.O. + 2 N.C. main poles</b>							
25	25	-	12...20	0 0	AF09Z-22-00-20	1SBL136501R2000	0.310
		24...60	20...60	0 0	AF09Z-22-00-21	1SBL136501R2100	0.310
		48...130	48...130	0 0	AF09Z-22-00-22	1SBL136501R2200	0.310
		100...250	100...250	0 0	AF09Z-22-00-23	1SBL136501R2300	0.310
30	30	-	12...20	0 0	AF16Z-22-00-20	1SBL176501R2000	0.310
		24...60	20...60	0 0	AF16Z-22-00-21	1SBL176501R2100	0.310
		48...130	48...130	0 0	AF16Z-22-00-22	1SBL176501R2200	0.310
		100...250	100...250	0 0	AF16Z-22-00-23	1SBL176501R2300	0.310
45	45	-	12...20	0 0	AF26Z-22-00-20	1SBL236501R2000	0.400
		24...60	20...60	0 0	AF26Z-22-00-21	1SBL236501R2100	0.400
		48...130	48...130	0 0	AF26Z-22-00-22	1SBL236501R2200	0.400
		100...250	100...250	0 0	AF26Z-22-00-23	1SBL236501R2300	0.400
55	55	-	12...20	0 0	AF38Z-22-00-20	1SBL296501R2000	0.400
		24...60	20...60	0 0	AF38Z-22-00-21	1SBL296501R2100	0.400
		48...130	48...130	0 0	AF38Z-22-00-22	1SBL296501R2200	0.400
		100...250	100...250	0 0	AF38Z-22-00-23	1SBL296501R2300	0.400

Note: Only AF.Z contactors with DC control voltage 12...20 V DC need to respect the connection polarities indicated close to the coil terminals: A1+ for the positive pole and A2- for the negative pole.

#### Main dimensions mm, inches

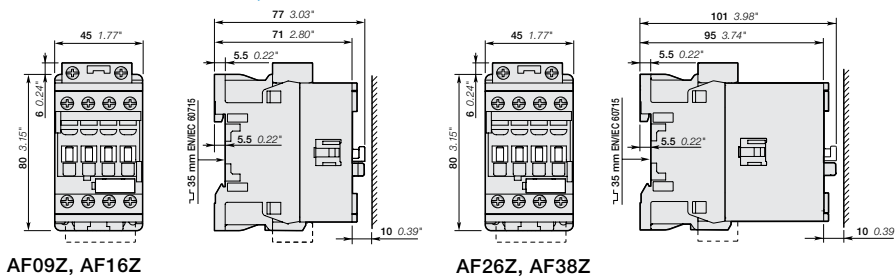

# NF 4-pole control relays

## Pilot duty rated A600 / Q600

### AC / DC operated

2



NF22E

#### Description

NF control relays are used for switching auxiliary and control circuits.

These control relays are of the block type design with:

- 4 poles. Control relays have mechanically linked auxiliary contact elements (side-marked symbol)
- control circuit: AC or DC operated with electronic coil interface accepting a wide control voltage range (e.g. 100...250 V AC and DC)
  - can manage large control voltage variations
  - only 4 control voltage ranges covering 24...500 V 50/60 Hz and 20...500 V DC
  - reduced panel energy consumption
  - very distinct closing and opening
- built-in surge suppression
- add-on auxiliary contact blocks for front or side mounting and a wide range of accessories

#### Ordering details

Number of contacts	Rated control circuit voltage		Catalog number	Global reference code	Weight Pkg (1 pce) kg	
	Uc min. ... Uc max.					
	V 50/60 Hz	V DC				
	24...60	-	(1)	NF22E-41	1SBH137001R4122	0.270
	48...130	48...130		NF22E-12	1SBH137001R1222	0.270
	100...250	100...250		NF22E-13	1SBH137001R1322	0.270
	250...500	250...500		NF22E-14	1SBH137001R1422	0.310
	24...60	-	(1)	NF31E-41	1SBH137001R4131	0.270
	48...130	48...130		NF31E-12	1SBH137001R1231	0.270
	100...250	100...250		NF31E-13	1SBH137001R1331	0.270
	250...500	250...500		NF31E-14	1SBH137001R1431	0.310
	24...60	-	(1)	NF40E-41	1SBH137001R4140	0.270
	48...130	48...130		NF40E-12	1SBH137001R1240	0.270
	100...250	100...250		NF40E-13	1SBH137001R1340	0.270
	250...500	250...500		NF40E-14	1SBH137001R1440	0.310

(1) For 24...60 V 50/60 Hz - 20...60 V DC, use NF..E-11 (see voltage code table). NF..E-11 not suitable for direct control by PLC-output.

#### Main dimensions mm, inches

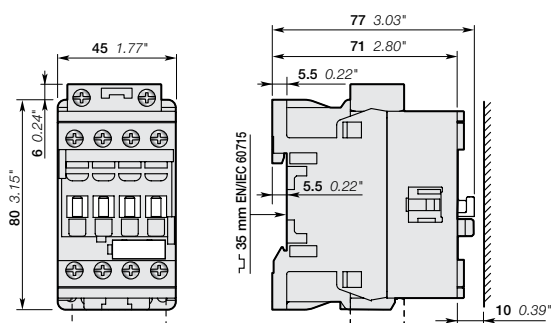

NF22E, NF31E, NF40E

# NFZ 4-pole control relays

## Pilot duty rated A600 / Q600

### AC / DC operated - low consumption



NFZ22E

#### Description

NFZ control relays are used for switching auxiliary and control circuits.

These control relays are of the block type design with:

- 4 poles. Control relays have mechanically linked auxiliary contact elements (side-marked symbol)
- control circuit: AC or DC operated with electronic coil interface accepting a wide control voltage range (e.g. 100...250 V AC and DC)
  - can manage large control voltage variations
  - only 4 control voltage ranges covering 24...250 V 50/60 Hz and 12...250 V DC
  - allow direct control by PLC-output  $\geq 24$  V DC 500 mA
  - reduced panel energy consumption
  - very distinct closing and opening
  - can withstand short voltage dips and voltage sags (SEMI F47-0706 conditions of use on request).
- built-in surge suppression
- add-on auxiliary contact blocks for front or side mounting and a wide range of accessories.

#### Ordering details

Number of contacts	Rated control circuit voltage Uc min. ... Uc max.		Catalog number	Global reference code	Weight Pkg (1 pce) kg
	V 50/60 Hz	V DC			
	-	12...20	NFZ22E-20	1SBH136001R2022	0.310
	24...60	20...60	NFZ22E-21	1SBH136001R2122	0.310
	48...130	48...130	NFZ22E-22	1SBH136001R2222	0.310
	100...250	100...250	NFZ22E-23	1SBH136001R2322	0.310
	-	12...20	NFZ31E-20	1SBH136001R2031	0.310
	24...60	20...60	NFZ31E-21	1SBH136001R2131	0.310
	48...130	48...130	NFZ31E-22	1SBH136001R2231	0.310
	100...250	100...250	NFZ31E-23	1SBH136001R2331	0.310
	-	12...20	NFZ40E-20	1SBH136001R2040	0.310
	24...60	20...60	NFZ40E-21	1SBH136001R2140	0.310
	48...130	48...130	NFZ40E-22	1SBH136001R2240	0.310
	100...250	100...250	NFZ40E-23	1SBH136001R2340	0.310

Note: Only NFZ contactor relays with DC control voltage 12...20 V DC need to respect the connection polarities indicated close to the coil terminals: A1+ for the positive pole and A2- for the negative pole.

#### Main dimensions mm, inches

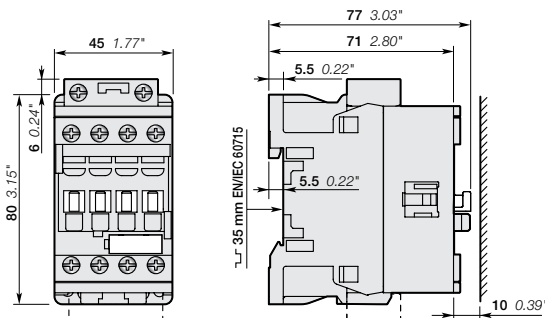

NFZ22E, NFZ31E, NFZ40E

# NF 8-pole control relays

## Pilot duty rated A600 / Q600

### AC / DC operated

2



NF44E

#### Description

NF control relays are used for switching auxiliary and control circuits.

These control relays are of the block type design with:

- 8 poles with a permanently fixed 4-pole auxiliary contact block. Control relays have mechanically linked auxiliary contact elements (side-marked symbol)
- control circuit: AC or DC operated with electronic coil interface accepting a wide control voltage range (e.g. 100...250 V AC and DC)
  - can manage large control voltage variations
  - only 4 control voltage ranges covering 24...500 V 50/60 Hz and 20...500 V DC
  - reduced panel energy consumption
  - very distinct closing and opening
- built-in surge suppression
- add-on auxiliary contact blocks for side mounting and a wide range of accessories

#### Ordering details

Number of contacts		Rated control circuit voltage Uc min. ... Uc max.	Catalog number	Global reference code	Weight Pkg (1 pce) kg	
1st stack	2nd stack					
		V 50/60 Hz	V DC			
		24...60	- (1)	NF44E-41	1SBH137001R4144	0.320
		48...130	48...130	NF44E-12	1SBH137001R1244	0.320
		100...250	100...250	NF44E-13	1SBH137001R1344	0.320
		250...500	250...500	NF44E-14	1SBH137001R1444	0.360
		24...60	- (1)	NF53E-41	1SBH137001R4153	0.320
		48...130	48...130	NF53E-12	1SBH137001R1253	0.320
		100...250	100...250	NF53E-13	1SBH137001R1353	0.320
		250...500	250...500	NF53E-14	1SBH137001R1453	0.360
		24...60	- (1)	NF62E-41	1SBH137001R4162	0.320
		48...130	48...130	NF62E-12	1SBH137001R1262	0.320
		100...250	100...250	NF62E-13	1SBH137001R1362	0.320
		250...500	250...500	NF62E-14	1SBH137001R1462	0.360
		24...60	- (1)	NF71E-41	1SBH137001R4171	0.320
		48...130	48...130	NF71E-12	1SBH137001R1271	0.320
		100...250	100...250	NF71E-13	1SBH137001R1371	0.320
		250...500	250...500	NF71E-14	1SBH137001R1471	0.360
		24...60	- (1)	NF80E-41	1SBH137001R4180	0.320
		48...130	48...130	NF80E-12	1SBH137001R1280	0.320
		100...250	100...250	NF80E-13	1SBH137001R1380	0.320
		250...500	250...500	NF80E-14	1SBH137001R1480	0.360

(1) For 24...60 V 50/60 Hz - 20...60 V DC, use NF.E-11 (see voltage code table). NF.E-11 not suitable for direct control by PLC-output.

#### Main dimensions mm, inches

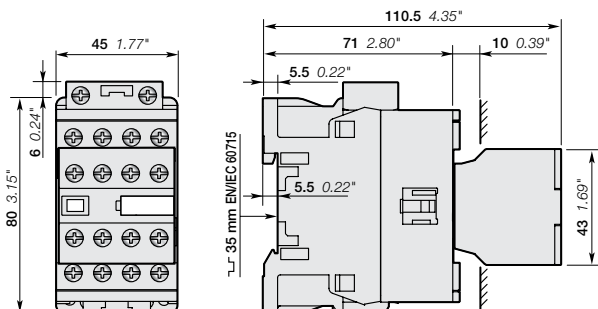

NF44E, NF53E, NF62E, NF71E, NF80E

# NFZ 8-pole control relays

## Pilot duty rated A600 / Q600

### AC / DC operated – Low consumption



NFZ44E

#### Description

NFZ control relays are used for switching auxiliary and control circuits.

These control relays are of the block type design with:

- 8 poles with a permanently fixed 4-pole auxiliary contact block. Control relays have mechanically linked auxiliary contact elements (side-marked symbol)
- control circuit: AC or DC operated with electronic coil interface accepting a wide control voltage range (e.g. 100...250 V AC and DC)
  - can manage large control voltage variations
  - only 4 control voltage ranges covering 24...250 V 50/60 Hz and 12...250 V DC
  - allow direct control by PLC-output  $\geq 24$  VDC 500 mA
  - reduced panel energy consumption
  - very distinct closing and opening
  - can withstand short voltage dips and voltage sags (SEMI F47-0706 conditions of use on request)
- built-in surge suppression
- add-on auxiliary contact blocks for side mounting and a wide range of accessories

#### Ordering details

Number of contacts		Rated control circuit voltage Uc min. ... Uc max.	Catalog number	Global reference code	Weight kg	
1st stack	2nd stack					
		<b>V 50/60 Hz</b>	<b>V DC</b>			
					<b>Pkg (1 pce)</b>	
					<b>kg</b>	
		–	12...20	NFZ44E-20	1SBH136001R2044	0.360
		24...60	20...60	NFZ44E-21	1SBH136001R2144	0.360
		48...130	48...130	NFZ44E-22	1SBH136001R2244	0.360
		100...250	100...250	NFZ44E-23	1SBH136001R2344	0.360
		–	12...20	NFZ53E-20	1SBH136001R2053	0.360
		24...60	20...60	NFZ53E-21	1SBH136001R2153	0.360
		48...130	48...130	NFZ53E-22	1SBH136001R2253	0.360
		100...250	100...250	NFZ53E-23	1SBH136001R2353	0.360
		–	12...20	NFZ62E-20	1SBH136001R2062	0.360
		24...60	20...60	NFZ62E-21	1SBH136001R2162	0.360
		48...130	48...130	NFZ62E-22	1SBH136001R2262	0.360
		100...250	100...250	NFZ62E-23	1SBH136001R2362	0.360
		–	12...20	NFZ71E-20	1SBH136001R2071	0.360
		24...60	20...60	NFZ71E-21	1SBH136001R2171	0.360
		48...130	48...130	NFZ71E-22	1SBH136001R2271	0.360
		100...250	100...250	NFZ71E-23	1SBH136001R2371	0.360
		–	12...20	NFZ80E-20	1SBH136001R2080	0.360
		24...60	20...60	NFZ80E-21	1SBH136001R2180	0.360
		48...130	48...130	NFZ80E-22	1SBH136001R2280	0.360
		100...250	100...250	NFZ80E-23	1SBH136001R2380	0.360

Note: Only NFZ contactor relays with DC control voltage 12...20 V DC need to respect the connection polarities indicated close to the coil terminals: A1+ for the positive pole and A2- for the negative pole.

#### Main dimensions mm, inches

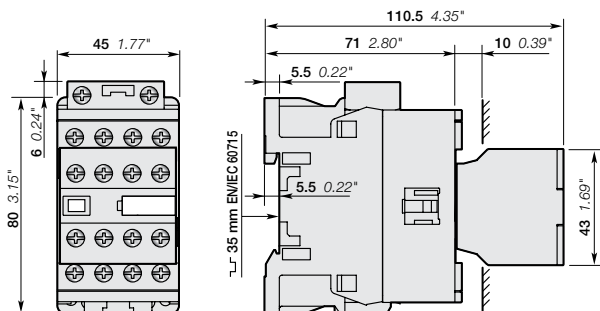

NFZ44E, NFZ53E, NFZ62E, NFZ71E, NFZ80E

# Voltage code table

The below tables indicate the available coil voltages and corresponding digits for catalog numbers. When placing an order, please give the catalog number. Select a standard contactor from ordering detail pages. Change the coil voltage code in the catalog number according to the table below.

Example: for contactor AF400-30-11 and coil 100...250 V 50/60 Hz, the catalog number is AF400-30-11-70.

## 2 AF09 ... AF370 3-pole contactors AF09 ... AF38 4-pole contactors

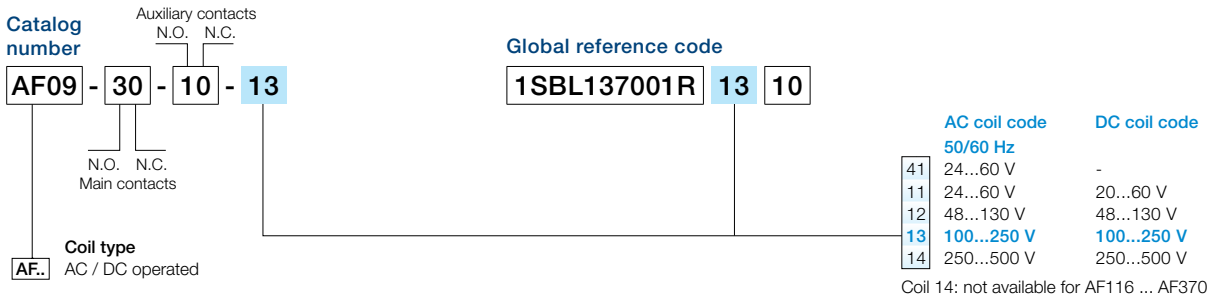

## AF400 ... AF2650 3-pole contactors

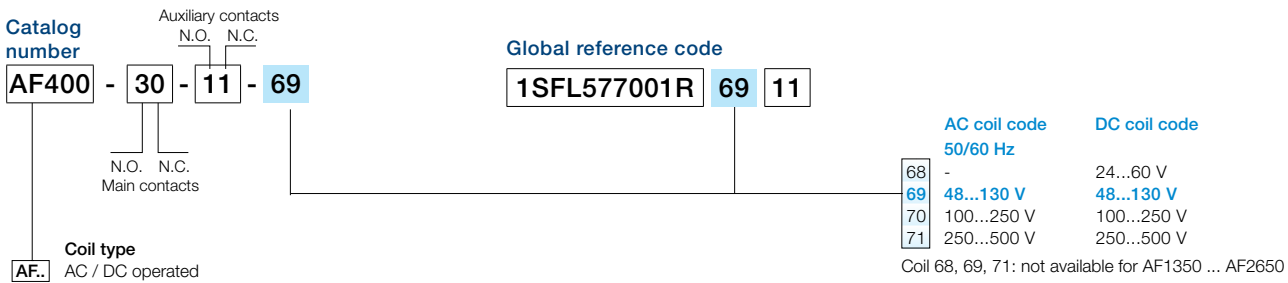

## AF09 ... AF38 3- and 4-pole contactors - low consumption

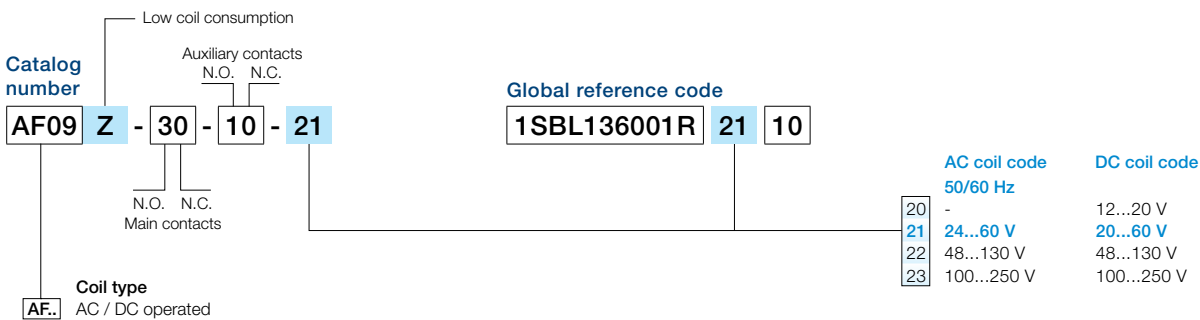

# Voltage code table

## NF control relays

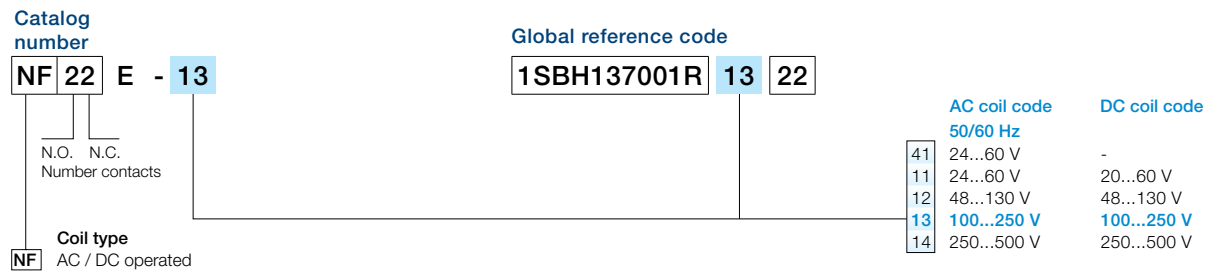

## NF control relays - low consumption

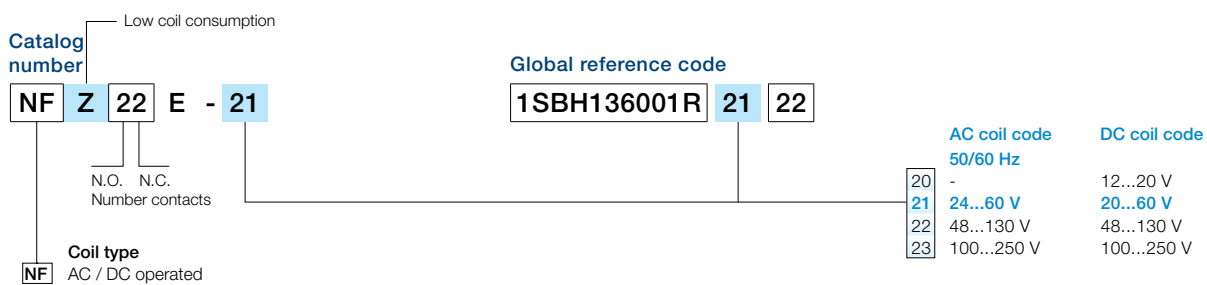

# AF09 ... AF96 3-pole contactors

## Accessory fitting details

### Contactor and main accessories (other accessories available)

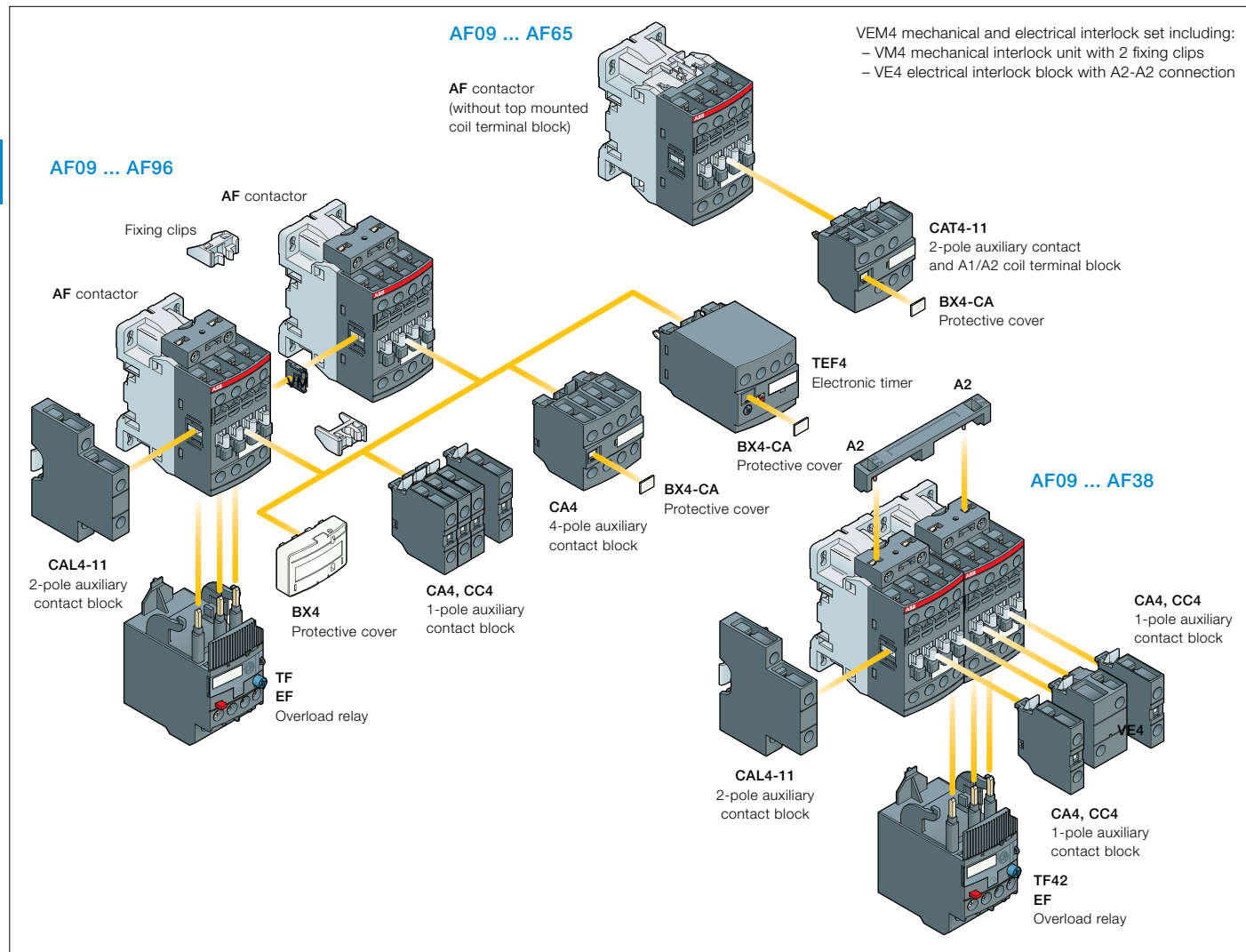

### Main accessory fitting details

Many configurations of accessories are possible depending on whether these are front-mounted or side-mounted.

Contactor types	Main poles		Built-in auxiliary contacts		Front-mounted accessories					Side-mounted accessories			
					Auxiliary contact blocks			Electronic timer	Electrical and mechanical interlock set (between 2 contactors)	Auxiliary contact blocks			
					1-pole CA4					Left side	Right side		
					1-pole CC4		2-pole CAT4-11	4-pole CA4	TEF4	VEM4	2-pole CAL4-11		
					Max. N.C. built-in and add-on N.C. auxiliary contacts: 4 N.C. max. on positions 1, 2, 3, 4 and 3 N.C. max. on positions 1 ±30°, 5								
AF09 ... AF16	3	0	0	1	4 max.	or 1		or 1	or 1	-	+ 1	-	
AF09 ... AF16	3	0	1	0	2 max.	or 1			or 1	-	+ 1	+ 1	
AF26 ... AF38	3	0	0	0	3 max.				-	+ 1	+ 1	or 1	
AF40 ... AF65	3	0	0	0	4 max.	or 1		or 1	or 1	-	+ 1	+ 1	
AF80, AF96	3	0	0	0	4 max.			or 1	or 1	-	+ 1	+ 1	

### Overload relays fitting details (1)

Contactor types	Thermal overload relays	Electronic overload relays
AF09 ... AF38	TF42 (0.10...38 A)	EF19 (0.10...19 A)
AF26 ... AF38	TF42 (0.10...38 A)	EF45 (9...45 A)
AF40 ... AF65	TF65 (22...67 A)	EF65 (25...70 A)
AF80, AF96	TF96 (40...96 A)	EF96 (36...100 A)

The addition of an overload relay on the contactor does not prevent fitting of many other accessories as shown above.

(1) Direct mounting - No kit required.





# AF09 ... AF96 3-pole contactors

## Accessory fitting details

### For AF09 ... AF38 contactors + CE5 auxiliary contacts for severe industrial environments

#### Main accessory fitting details

Many configurations of accessories are possible depending on whether these are front-mounted or side-mounted.

Contactor types	Main poles 	Built-in auxiliary contacts 	Front-mounted accessories			Side-mounted accessories		
			Auxiliary contact blocks			Electronic timer mechanical interlock set (between 2 contactors) VEM4	Auxiliary contact blocks	
			1-pole CE5	1-pole CA4 1-pole CC4		Left side 2-pole CAL4-11	Right side	

#### 3-pole contactors AF09 ... AF38

Max. N.C. built-in and add-on N.C. auxiliary contacts (CA4, CC4, CAL4, VEM4):  
2 max. with 1 CE5, none with 2 CE5 on positions 1, 2, 3, 4

AF09 ... AF16	3 0	0 1	1	+	3 max.	-	+	1	-
AF09 ... AF16	3 0	1 0	2	+	2 max.	-	-	-	-
AF26 ... AF38	3 0	0 0	1	+	3 max.	-	+	1	-
			1	+	1 max.	-	+	1	+ 1
			1	+	2 max.	+ 1	+	1	-
1 max. N.C. built-in and add-on N.C. auxiliary contacts (CA4, CC4, CAL4, VEM4) on positions 1 ±30°, 5									
AF09 ... AF16	3 0	0 1	1	+	3 max.	-	-	-	-
AF09 ... AF16	3 0	1 0	1	+	3 max.	-	+	1	-
AF26 ... AF38	3 0	0 0	1	+	2 max.	+ 1	-	-	-

#### 4-pole contactors AF09 ... AF38

Max. add-on N.C. auxiliary contacts (CA4, CC4, CAL4, VEM4):  
2 max. with 1 CE5, none with 2 CE5 on positions 1, 2, 3, 4

AF09, AF16	4 0	0 0	2	+	2 max.	-	-	-	-	
			1	+	3 max.	-	+	1	-	
			1	+	1 max.	-	+	1	+ 1	-
			1	+	2 max.	+ 1	+	1	-	
1 max. add-on N.C. auxiliary contacts (CA4, CC4, CAL4, VEM4) on positions 1, 2, 3, 4										
AF26, AF38	4 0	0 0	1	+	3 max.	-	+	1	-	
			1	+	2 max.	+ 1	-	-	-	
AF09, AF16	2 2	0 0	1	+	3 max.	-	+	1	-	
AF26, AF38	2 2	0 0								
1 max. add-on N.C. auxiliary contacts (CA4, CC4, CAL4, VEM4) on positions 1 ±30°, 5										
AF09, AF16	4 0	0 0	1	+	3 max.	-	+	1	-	
			1	+	2 max.	+ 1	-	-	-	
No add-on N.C. auxiliary contacts on positions 1 ±30°, 5										
AF26, AF38	4 0	0 0	1	+	3 max.	-	-	-	-	
AF09, AF16	2 2	0 0								
AF26, AF38	2 2	0 0								

# AF116 ... AF370 3-pole contactors with 1 N.O. + 1 N.C. auxiliary contacts

## Accessory fitting details

### Main accessories (other accessories available)

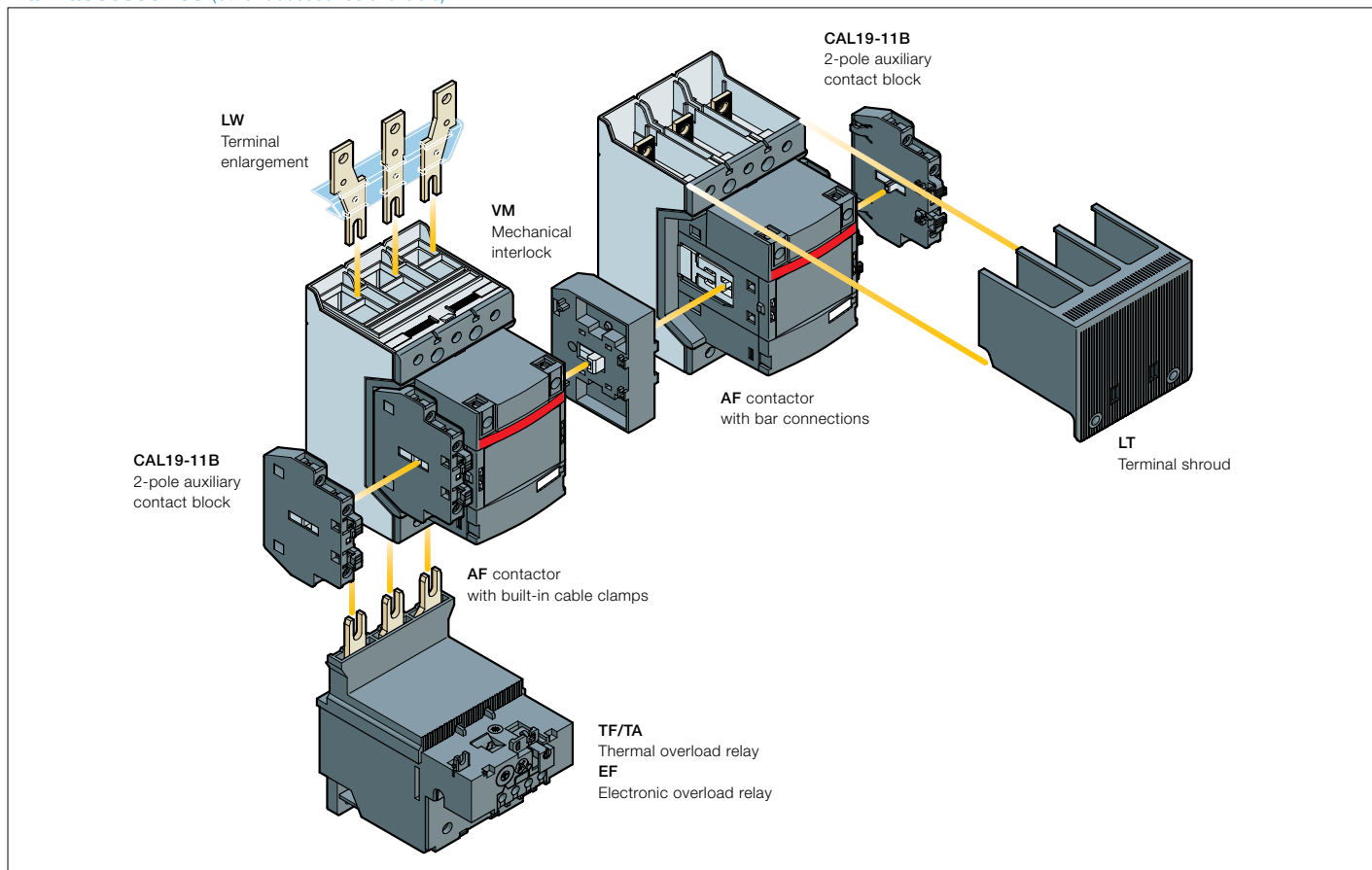

### Main accessory fitting details

Contactor types	Main poles	Available auxiliary contacts	Side-mounted accessories		
			Auxiliary contact blocks		Mechanical interlock units (between two contactors)
			CAL19-11	CAL19-11B	
AF116 ... AF370	3	0 1 1	1 x CAL19-11	+ 2 x CAL19-11B	-
AF116 ... AF370	3	0 1 1	-	+ 2 x CAL19-11B (1)	+ VM... (2)

(1) Total number of auxiliary contact blocks for the two contactors.

(2) Interlock type, according to the contactor ratings (see "Accessories").

### Overload relays fitting details (1)

Contactor types	Thermal overload relays	Electronic overload relays
AF116 ... AF140	TF140DU (66...142 A)	EF146 (54...150 A)
AF146	-	EF146 (54...150 A)
AF190, AF205	TA200DU (66...200 A)	EF205 (63...210 A)
AF265 ... AF370	-	EF370 (115...380 A)

The addition of a thermal or electronic overload relay on the contactor does not prevent fitting of many other accessories as shown in "Main accessory fitting details" table.

(1) Direct mounting - No kit required.

# AF400 ... AF2650 3-pole contactors with 1 N.O. + 1 N.C. auxiliary contacts Accessory fitting details

## Main accessories (other accessories available)

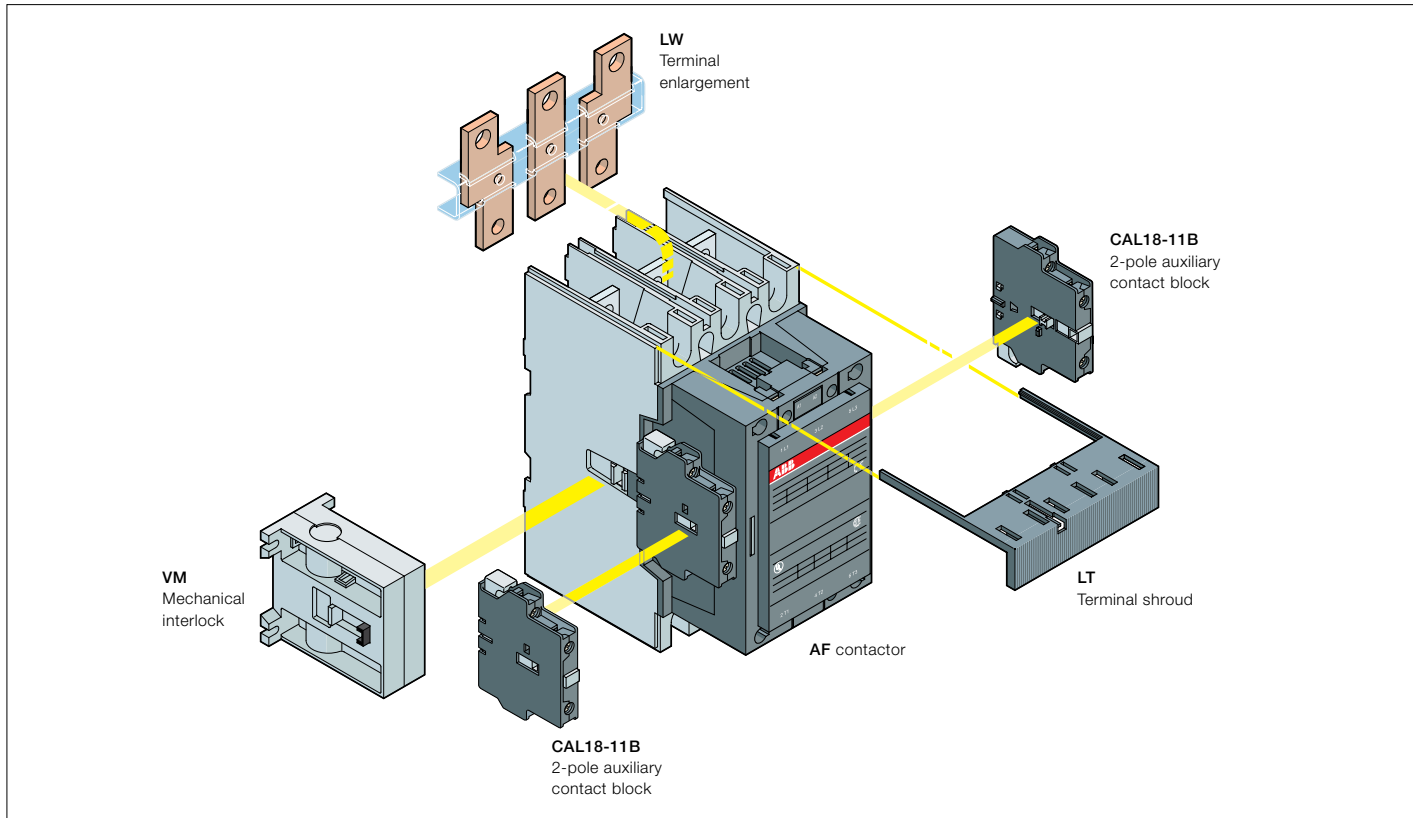

## Main accessory fitting details

Contactor types	Main poles	Available auxiliary contacts	Side-mounted accessories		
			Auxiliary contact blocks		
			CAL18-11	CAL18-11B (3)	Mechanical interlock units (between two contactors)

### Contactors + auxiliary contact blocks

AF400 ... AF2650	3	0	1	1	1 x CAL18-11	+	2 x CAL18-11B	-
------------------	---	---	---	---	--------------	---	---------------	---

### Contactors with mechanical interlocking + auxiliary contact blocks

AF400 ... AF2650	3	0	1	1	2 x CAL18-11 (1)	+	4 x CAL18-11B (1)	+	VM...H (2)
------------------	---	---	---	---	------------------	---	-------------------	---	------------

(1) Total number of auxiliary contact blocks for the two contactors. (2) Interlock type, according to the contactor ratings (see "Accessories").  
(3) The CEL18-... auxiliary contact blocks can replace the CAL18-11 and CAL18-11B. Though, no auxiliary contact block can be mounted outside the CEL18-...

## Overload relays fitting details

Contactor types	Thermal overload relays	Electronic overload relays
AF400, AF460	-	E500DU (150...500 A) (4)
AF580, AF750	-	E800DU (250...800 A) (4)
AF1350, AF1650	-	E1250DU (375...1250 A) (4)

The addition of a thermal or electronic overload relay on the contactor does not prevent fitting of many other accessories as shown in "Main accessory fitting details" table.  
(4) Mounting kit required (see overload relay page).

# AF09 ... AF38 4-pole contactors

## Accessory fitting details

### Contactor and main accessories (other accessories available)

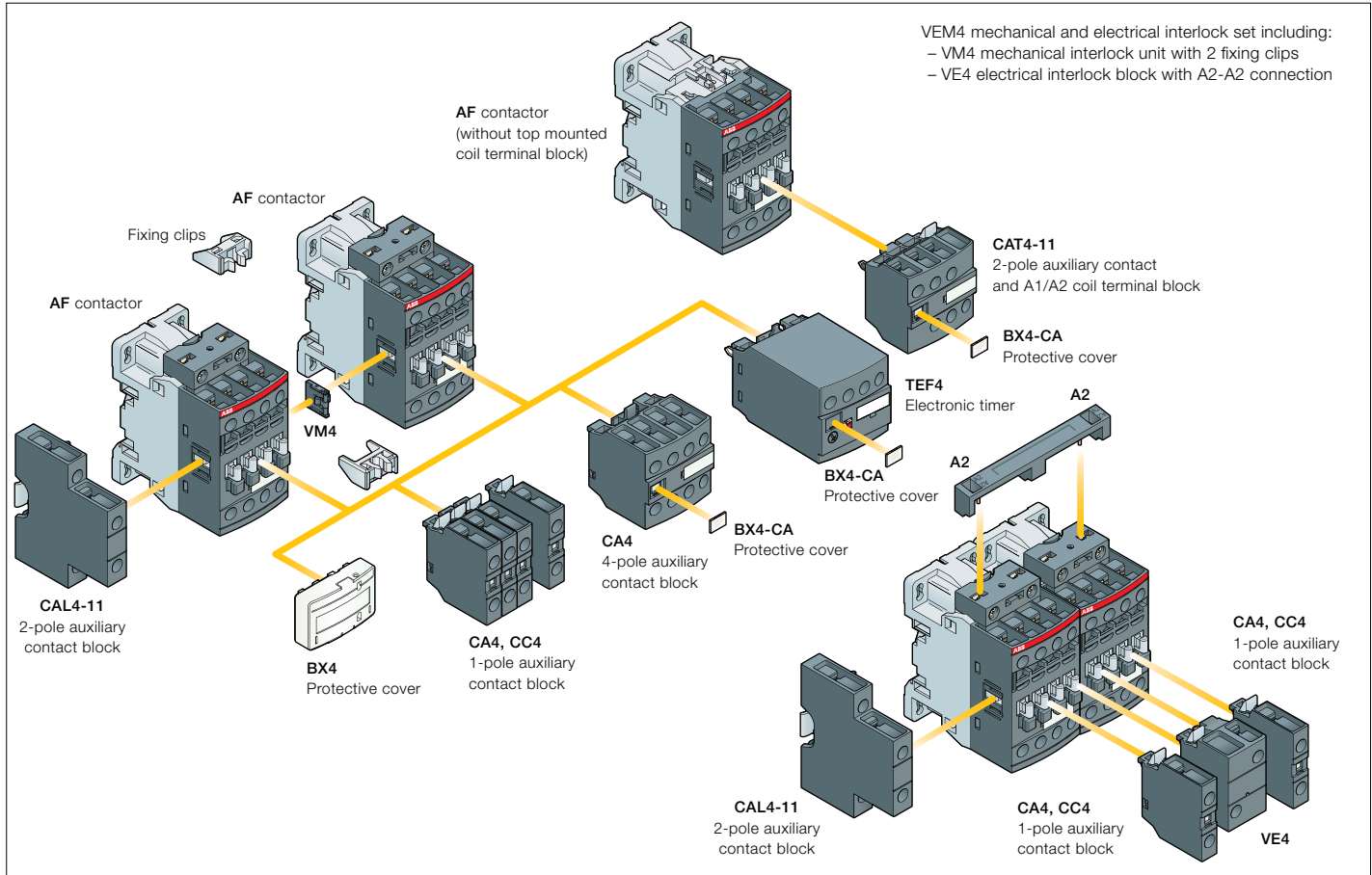

### Main accessory fitting details

Many configurations of accessories are possible depending on whether these are front-mounted or side-mounted.

Contactor types	Main poles	Built-in auxiliary contacts	Front-mounted accessories				Side-mounted accessories				
			Auxiliary contact blocks			Electronic timer	Electrical and mechanical interlock set (between 2 contactors)	Auxiliary contact blocks			
			1-pole CA4 1-pole CC4	2-pole CAT4-11	4-pole CA4	TEF4	VEM4	Left side 2-pole CAL4-11	Right side		
Max. add-on N.C. auxiliary contacts: 4 N.C. max. on positions 1, 2, 3, 4 and 3 N.C. max. on positions 1 ±30°, 5											
AF09 ... AF16	4	0	0	0	4 max. or 1	or 1	or 1	+	1	-	
					2 max. or 1	-	or 1	+	1	+ 1	
					3 max. -	-	-	+ 1	+	1	or 1
Max. add-on N.C. auxiliary contacts: 3 N.C. max. on positions 1, 2, 3, 4 and 2 N.C. max. on positions 1 ±30°, 5											
AF26 ... AF38	4	0	0	0	4 max. or 1	or 1	or 1	-	+	1	-
					2 max. or 1	-	or 1	-	+	1	+ 1
					3 max. -	-	-	+ 1	+	1	or 1
AF09 ... AF16	2	2	0	0	4 max. or 1	or 1	or 1	-	+	1	-
AF26 ... AF38	2	2	0	0	2 max. or 1	-	or 1	-	+	1	+ 1

# NF 4-pole control relays

## Accessory fitting details

### Control relays and main accessories (other accessories available)

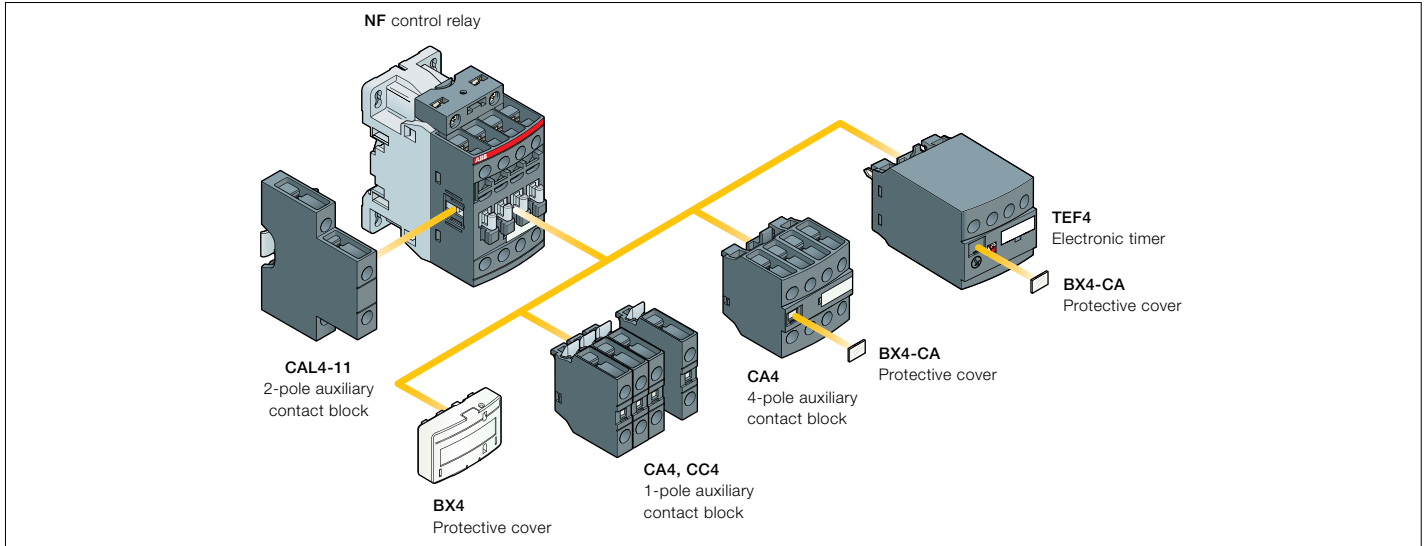

### Main accessory fitting details

Many configurations of accessories are possible depending on whether these are front-mounted or side-mounted.

Control relay types	Main poles	Front-mounted accessories			Electronic timer		Side-mounted accessories	
		Auxiliary contact blocks			TEF4		Left side	Right side
		1-pole CA4	1-pole CC4	4-pole CA4			2-pole CAL4-11	
Max. add-on N.C. auxiliary contacts: 3 N.C. max. on positions 1, 2, 3, 4 and 2 N.C. max. on positions 1 ±30°, 5								
NF	2 2 3 1	E	4 max.	or 1	or 1	+	1	-
		E	2 max.	-	or 1	+	1	+ 1
Max. add-on N.C. auxiliary contacts: 4 N.C. max. on positions 1, 2, 3, 4 and 3 N.C. max. on positions 1 ±30°, 5								
NF	4 0	E	4 max.	or 1	or 1	+	1	-
		E	2 max.	-	or 1	+	1	+ 1

### For NF control relays + CE5 auxiliary contacts for severe industrial environments

#### Main accessory fitting details

Many configurations of accessories are possible depending on whether these are front-mounted or side-mounted.

Control relay types	Main poles	Front-mounted accessories			Side-mounted accessories	
		Auxiliary contact blocks			Left side	Right side
		1-pole CE5	1-pole CA4	1-pole CC4	2-pole CAL4-11	
Max. add-on N.C. auxiliary contacts (CA4, CC4, CAL4): 1 max. with 1 CE5 on positions 1, 2, 3, 4						
NF	2 2 3 1	E	1	+ 3 max.	+	1
		E				
Max. add-on N.C. auxiliary contacts (CA4, CC4, CAL4): 2 max. with 1 CE5, none with 2 CE5 on positions 1, 2, 3, 4						
NF	4 0	E	2	+ 2 max.	-	-
		E	1	+ 3 max.	-	-
		E	1	+ 1 max.	+	1
Max. add-on N.C. auxiliary contacts (CA4, CC4): none with 1 CE5 on positions 1 ±30°, 5						
NF	2 2 3 1	E	1	+ 3 max.	-	-
		E				
Max. add-on N.C. auxiliary contacts (CA4, CC4, CAL4): 1 max. with 1 CE5 on positions 1 ±30°, 5						
NF	4 0	E	1	+ 3 max.	-	+
		E				1

# NF 8-pole control relays

## Accessory fitting details

### Control relays and main accessories (other accessories available)

2

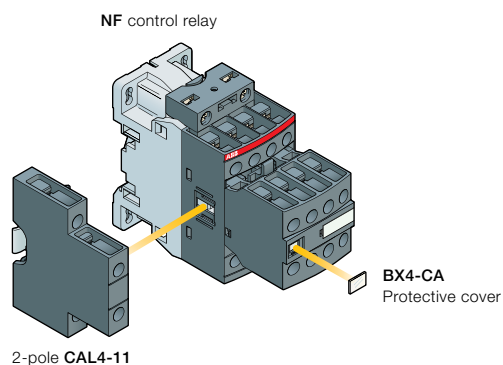

### Main accessory fitting details

Many configurations of accessories are possible depending on whether these are front-mounted or side-mounted.

Control relay types	Main poles	Front-mounted accessories				Side-mounted accessories																
		Auxiliary contact blocks				Auxiliary contact blocks																
		1-pole CA4	1-pole CC4	4-pole CA4		Left side	Right side															
						2-pole CAL4-11																
NF	<table style="border-collapse: collapse; margin-left: 20px;"> <tr> <td style="padding-right: 10px;">4</td> <td style="padding-right: 10px;">4</td> <td style="padding-right: 10px;">E</td> </tr> <tr> <td>5</td> <td>3</td> <td>E</td> </tr> <tr> <td>6</td> <td>2</td> <td>E</td> </tr> <tr> <td>7</td> <td>1</td> <td>E</td> </tr> <tr> <td>8</td> <td>0</td> <td>E</td> </tr> </table>	4	4	E	5	3	E	6	2	E	7	1	E	8	0	E	-		-	+	1	-
4	4	E																				
5	3	E																				
6	2	E																				
7	1	E																				
8	0	E																				

# Auxiliary contact blocks for AF09 ... AF96 contactors and NF control relays



CA4-10



CAL4-11



CA4-22E



CAT4-11E

## Description

The auxiliary contact blocks are used for the operation of auxiliary circuits and control circuits for standard industrial environments.

Types of auxiliary contact blocks for front mounting:

- CA4 1 or 4-pole block, with instantaneous N.O., N.C. contacts
- CC4 1-pole block, with N.O. leading contact or N.C. lagging contact
- CAT4 2-pole block, with instantaneous N.O. + N.C. contacts and A1 / A2 coil terminal connection on front face.

Select the 4-pole auxiliary contact blocks CA4-..E, CA4-..M, CA4-..U or CA4-..N type, according to the contactor or contactor relay type for compliance with the standard requirements (see "Terminal marking and positioning").





Types of auxiliary contact blocks for side mounting:

- CAL4 2-pole block, with instantaneous N.O. + N.C. contacts.

For clipping onto the right- and/or left-hand side of the contactors.

The auxiliary contact blocks are equipped with screw type connecting terminals delivered open, protected against accidental direct contact and bear the corresponding function marking.

## Ordering details (1)

For contactors	Auxiliary contacts	Catalog number	Global reference code	Pkg qty	Weight (1 pce)
	   				kg

### Front-mounted instantaneous auxiliary contact blocks

AF09 ... AF96 4-pole NF	1	0	-	-	CA4-10	1SBN010110R1010	1	0.014
	1	0	-	-	CA4-10-T	1SBN010110T1010	10	0.014
	0	1	-	-	CA4-01	1SBN010110R1001	1	0.014
	0	1	-	-	CA4-01-T	1SBN010110T1001	10	0.014
AF09 ... AF16..-30-10	2	2	-	-	CA4-22M	1SBN010140R1122	1	0.055
	3	1	-	-	CA4-31M	1SBN010140R1131	1	0.055
	1	3	-	-	CA4-13M	1SBN010140R1113	1	0.055
	0	4	-	-	CA4-04M	1SBN010140R1104	1	0.055
AF26 ... AF96..-30-00 AF09 ... AF38..-40-00 AF09 ... AF38..-22-00	2	2	-	-	CA4-22E	1SBN010140R1022	1	0.055
	3	1	-	-	CA4-31E	1SBN010140R1031	1	0.055
	4	0	-	-	CA4-40E	1SBN010140R1040	1	0.055
	0	4	-	-	CA4-04E	1SBN010140R1004	1	0.055
AF09 ... AF16..-30-01	2	2	-	-	CA4-22U	1SBN010140R1322	1	0.055
	3	1	-	-	CA4-31U	1SBN010140R1331	1	0.055
	4	0	-	-	CA4-40U	1SBN010140R1340	1	0.055
	4-pole NF	2	2	-	-	CA4-22N	1SBN010140R1222	1
3		1	-	-	CA4-31N	1SBN010140R1231	1	0.055
4		0	-	-	CA4-40N	1SBN010140R1240	1	0.055
1		3	-	-	CA4-13N	1SBN010140R1213	1	0.055
NF..40E	0	4	-	-	CA4-04N	1SBN010140R1204	1	0.055

### Front-mounted auxiliary contact blocks with N.O. leading contact and N.C. lagging contact

AF09 ... AF96 4-pole NF	-	-	1	0	CC4-10	1SBN010111R1010	1	0.014
	-	-	0	1	CC4-01	1SBN010111R1001	1	0.014

### Side-mounted instantaneous auxiliary contact blocks

AF09 ... AF96 NF	1	1	-	-	CAL4-11	1SBN010120R1011	1	0.040
	1	1	-	-	CAL4-11-T	1SBN010120T1011	10	0.040

### Front-mounted instantaneous auxiliary contact and A1/A2 coil terminal blocks

AF09 ... AF16..-30-10	1	1	-	-	CAT4-11M	1SBN010151R1111	1	0.040
AF26 ... AF65..-30-00 AF09 ... AF38..-40-00 AF09 ... AF38..-22-00	1	1	-	-	CAT4-11E	1SBN010151R1011	1	0.040
AF09 ... AF16..-30-01	1	1	-	-	CAT4-11U	1SBN010151R1311	1	0.040

(1) For each contactor or contactor relay type, refer to "Accessory fitting details" table.

**Note:** CAT4 not suitable for AF.Z contactors with DC control voltage 12...20 V DC.

# Auxiliary contact blocks for AF116 ... AF2650 contactors

2



CAL19-11

## Description

The auxiliary contact blocks are used for the operation of auxiliary circuits and control circuits for standard industrial environments.

Types of auxiliary contact blocks for side mounting:



- CAL 2-pole block, with instantaneous N.O. + N.C. contacts.

For clipping onto the right- and/or left-hand side of the contactors.

The CAL ...-11B is a second block for mounting in addition to a first CAL ...-11 block, right- and/or left-hand of the AF116 ... AF2650 contactors.

The auxiliary contact blocks are equipped with screw type connecting terminals delivered open, protected against accidental direct contact and bear the corresponding function marking.

## Ordering details

For contactors	Auxiliary contacts	Catalog number	Global reference code	Pkg qty	Weight (1 pce)
	 				kg

### Side-mounted instantaneous auxiliary contact blocks

AF116 ... AF370	1	1	CAL19-11	1SFN010820R1011	2	0.040
	1	1	CAL19-11B	1SFN010820R3311	2	0.040
AF400 ... AF2650	1	1	CAL18-11	1SFN010720R1011	2	0.050
	1	1	CAL18-11B	1SFN010720R3311	2	0.050

(1) For each contactor type, refer to "Accessory fitting details" table.



CAL18-11



# Auxiliary contact blocks for AF09 ... AF38 contactors and NF control relays for severe industrial environments



CE5-10W

## Description

The auxiliary contact blocks are used for the operation of auxiliary circuits and control circuits for severe industrial environments.

Types of auxiliary contact blocks for front mounting:

- CE5 1-pole block, instantaneous with N.O. contact or N.C. contact, available in 2 IP degrees
- CE5 D with built-in microswitch IP40, degree of protection (IP20 on terminals)
- CE5 W with built-in microswitch IP67, degree of protection (IP20 on terminals).

The auxiliary contact blocks are equipped with screw type connecting terminals delivered open, protected against accidental direct contact and bear the corresponding function marking.

## Ordering details (1)

For contactors	Auxiliary contacts	Catalog number	Global reference code	Pkg qty	Weight (1 pce) kg
AF09 ... AF38	1 - - -	CE5-10D0.1	1SBN010015R1010	1	0.020
NF	- 1 - -	CE5-01D0.1	1SBN010015R1001	1	0.020
	1 - - -	CE5-10D2	1SBN010017R1010	1	0.020
	- 1 - -	CE5-01D2	1SBN010017R1001	1	0.020
	1 - - -	CE5-10W0.1	1SBN010016R1010	1	0.020
	- 1 - -	CE5-01W0.1	1SBN010016R1001	1	0.020
	1 - - -	CE5-10W2	1SBN010018R1010	1	0.020
	- 1 - -	CE5-01W2	1SBN010018R1001	1	0.020

(1) For each contactor type, refer to "Accessory fitting details" table.

# Auxiliary contact blocks for AF400 ... AF2650 contactors for severe industrial environments

2



CEL18

## Description

The auxiliary contact blocks are used for the operation of auxiliary and control circuits for severe industrial environments.



Types of auxiliary contact blocks for side mounting:

- CEL18 1-pole block, with built-in microswitch IP67 degree of protection (IP20 on terminals). Instantaneous N.O. or N.C. contact.

For clipping onto the right- and/or left-hand side of the contactors.

The auxiliary contact blocks are equipped with screw type connecting terminals delivered open, protected against accidental direct contact and bear the corresponding function marking.

## Ordering details (1)

For contactors	Auxiliary contacts	Catalog number	Global reference code	Pkg qty	Weight (1 pce)
	 				kg
<b>Side-mounting instantaneous auxiliary contact blocks</b>					
AF400 ... AF2650	1 0	CEL18-10	1SFN010716R1010	1	0.050
	0 1	CEL18-01	1SFN010716R1001	1	0.050

(1) For each contactor type, refer to "Accessory fitting details" table.

# Impulse contact blocks

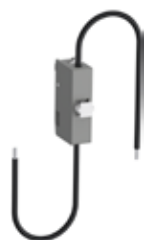

CB5

## Description

Impulse contact blocks are designed for use in enclosures, in association with an adjustable mechanical pushbutton. Two types are available:

CB5-10: N.O. contact with a black actuator ("ON" function)

CB5-01: N.C. contact with a light grey actuator ("OFF" function).

These blocks are equipped with 2 connecting leads 0.5 mm<sup>2</sup> with end, approximately 18 cm long.

Mounting: Clipped onto the front face of the contactors.

## Ordering details

For contactors	Contacts	Catalog number	Global reference code	Pkg qty	Weight (1 pce) kg
AF09 ... AF38	1 -	CB5-10	1SBN010013R1010	1	0.012
	- 1	CB5-01	1SBN010013R1001	1	0.012

Note: For AF40 ... AF96 mounting: please consult us.

## Main dimensions mm, inches

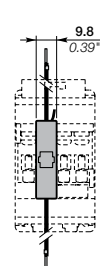

CB5-10

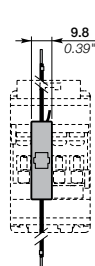
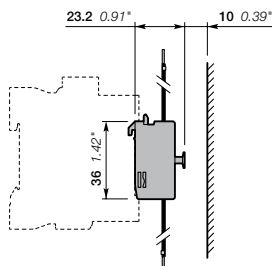

CB5-01

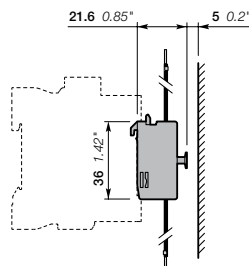

# Electronic timers

2



TEF4-ON

## Description

TEF4 front-mount electronic timers are used for timing function and are available in ON-delay and OFF-delay versions.

### Compact solution in cabinet compared to separate timers

TEF4 electronic timers are front-mounted and clip on AF contactors or NF control relays. A mechanical indicator shows the state of the contactor.

### Safe and cost-reduced wiring

TEF4 electronic timers are supplied by a direct plug-in parallel connection to the coil terminals A1 - A2 of the contactor or contactor relay. A varistor is integrated on the timer to offer a built-in protection against surges in the contactor coil.

### Available for a wide control voltage range 24...240 V AC/DC

TEF4-ON or TEF4-OFF allow time-delayed functions up to 100 s in 3 distinct time ranges, independently of the control system. The time delay ranges are selected by a switch and the time delay can be adjusted by means of a rotary switch. The timing function is activated by closing or opening the device on which the timer is mounted. The OFF-delay version operates without additional control supply.



TEF4-OFF

## Ordering details

For contactors, control relays	Time delay range selected by switch	Delay type	Rated control circuit voltage $U_c$	Auxiliary contacts	Catalog number	Global reference code	Weight Pkg (1 pce) kg
AF09 ... AF96 NF	0.1...1 s	ON-delay	24...240	1 1	TEF4-ON	1SBN020112R1000	0.065
	1...10 s 10...100 s	OFF-delay	24...240	1 1	TEF4-OFF	1SBN020114R1000	0.065



VM4



VM19

## Mechanical interlock units

### Description

The VM mechanical interlock units are designed for the interlocking of two AF contactors. When mounted between two contactors, the VM mechanical interlock unit prevents one of the contactors from closing as long as the other contactor is closed.

The mechanical interlock units VM4 and VM96-4 include 2 fixing clips.

### Ordering details

For contactors	Mounting	Catalog number	Global reference code	Pkg qty	Weight (1 pce) kg
<b>Mechanical interlock units for two contactors mounted side by side</b>					
AF09 ... AF38...-30-... AF09 ... AF38...-40-00	Fixed between two contactors, mounted flush side by side	VM4	1SBN030105T1000	10	0.005
AF40 ... AF96 For same size contactors: AF116 ... AF146 AF190, AF205 AF265 ... AF370		VM96-4	1SBN033405T1000	10	0.006
AF116 ... AF146 and AF190, AF205		VM19	1SFN030300R1000	1	0.054
AF116 ... AF146 and AF190, AF205		VM140/190	1SFN034403R1000	1	0.088
AF190, AF205 and AF265 ... AF370		VM205/265	1SFN035203R1000	1	0.090
AF400 ... AF1250	PN.. mounting plate to be ordered separately	VM750H	1SFN035700R1000	1	0.200
AF1350 ... AF2650	Plate included	VM1650H	1SFN036503R1000	1	6.000
<b>Mechanical interlock units for two contactors mounted one above the other</b>					
AF400 ... AF1250	Additional plate (not supplied)	VM750V	1SFN035701R1000	1	0.200

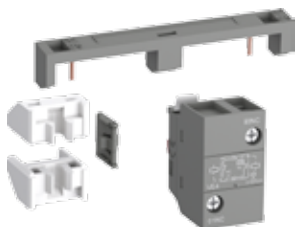

VEM4

## Mechanical and electrical interlock sets

### Description

VEM4 mechanical and electrical interlock set for the interlocking of two AF contactors. VEM4 set includes a mechanical interlock unit VM4 with 2 fixing clips (BB4) and a VE4 electrical interlock block with A2-A2 connection.

Fixing the electrical interlock block to the contactor front face connects the 2 built-in N.C. interlocking contacts with the two coils. VE4 block must be used with A2-A2 connection to respect the electrical connection diagram.

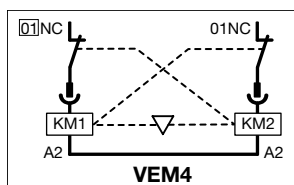

### Ordering details

For contactors	Auxiliary contacts	Catalog number	Global reference code	Pkg qty	Weight (1 pce) kg
<b>Mechanical and electrical interlock set</b>					
For same size contactors: AF09 ... AF16...-30-... AF26 ... AF38...-30-00 AF09, AF16...-40-00 AF26, AF38...-40-00	0 2	VEM4	1SBN030111R1000	1	0.035
<b>Fixing clips</b>					
AF09 ... AF38		BB4	1SBN110120W1000	50	0.002



BB4

Note: VEM4 not suitable for AF..Z contactors with DC control voltage 12...20 V DC.

# Mechanical latching units

2



WB75-A

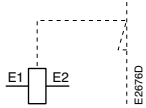

Terminal marking

## Description

For converting standard contactors into latched contactors.

The WB75-A block contains a mechanical latching device with electromagnetic impulse unlatching (AC or DC) or manual unlatching.

Captive screw type connecting terminals, built-in cable clamps, M3.5 (+, -) pozidriv 2 screw with screwdriver guidance; delivered untightened and protected against accidental direct contact.

## Operation

After closing, the contactor continues to be held in the closed position by the latching mechanism should the supply voltage fail at the contactor coil terminals.

Contactor opening can be controlled:

- electrically by an impulse (AC or DC) on the WB75-A block coil.  
(the coil is not designed to be permanently energized)
- manually by pressing the pushbutton on the front face of the WB75-A block.

## Mounting

The WB75-A block is clipped onto the front face of the 1-stack contactor where it takes up two slots. The two other slots do not accept CA4 single pole auxiliary contacts. Up to 2 CAL4-11 auxiliary contact blocks can be side-mounted on contactors (except NF22E and AF..-22-00, refer to main accessory fitting details table in main accessories section).

## Ordering details

For contactors	Rated control circuit voltage Uc		Catalog number	Global reference code	Pkg qty	Weight (1 pce) kg
	V 50 Hz or DC	V 60 Hz				
AF09 ... AF38 NF	24	24...28	WB75A-01	FPTN372726R1001	1	0.120
	42	42...48	WB75A-02	FPTN372726R1002	1	0.120
	48	48...55	WB75A-03	FPTN372726R1003	1	0.120
	110	110...127	WB75A-04	FPTN372726R1004	1	0.120
	220...230	220...255	WB75A-06	FPTN372726R1006	1	0.120
	230...240	230...277	WB75A-05	FPTN372726R1005	1	0.120
	380...415	380...440	WB75A-07	FPTN372726R1007	1	0.120
	415...440	440...480	WB75A-08	FPTN372726R1008	1	0.120

Note: For WB75-A produced since week 06-2012.

# Other accessories



LDC4

## Ordering details

For contactors	Catalog number	Global reference code	Pkg qty	Weight (1 pce)
				kg



BX4

## Additional coil terminal blocks

Additional coil terminal blocks for contactors or control relays.

AF09 ... AF96, NF	LDC4	1SBN070156T1000	10	0.010
-------------------	------	-----------------	----	-------

## Protective covers

Sealable and transparent protective covers BX4 and non-removable BX4-CA to protect the devices against accidental contact.

AF09 ... AF96 1-stack contactors and NF contactor relays	BX4	1SBN110108T1000	10	0.006
4-pole CA4, 2-pole CAT4 auxiliary contact blocks and TEF4 electronic timer	BX4-CA	1SBN110109W1000	50	0.001

Note: BX4 produced since 13045 (day 045 - year 2013) are suitable for AF40 ... AF96.



BX4-CA



BA4

## Function markers AF09 ... AF370

Box of 16 blank cards (16 markers by card) printable on HTP500 thermal transfer printer and AMS 500 marking table to identify your contactors, overload relays or manual motor starters.  
Marker dimensions: 7 x 20 mm (.276" x .787").

AF09 ... AF370 contactors, TF thermal overload relays, EF electronic overload relays and MS116, MS132 manual motor starters	BA4	1SNA235156R2700	16	0.011
AMS 500 support plate for 8 BA4	XUSP02633	1SNA360010R1500	1	0.220
HTP500 support plate	HTP500-BA4	1SNA235712R2400	1	0.290



BA5-50

## Function markers AF400 ... AF2650

Set of 50 function markers designed to be clipped onto the front face of devices. Details can be added to these markers using a ball point pen, indelible felt-tip pen or pentel white.  
Self-adhesive labels (not supplied) can also be added to them.  
Marker dimensions: 7 x 19 mm (.276" x .748").

AF400 ... AF2650 and accessories	BA5-50	1SBN110000R1000	50	0.017
----------------------------------	--------	-----------------	----	-------

## Main dimensions mm, inches

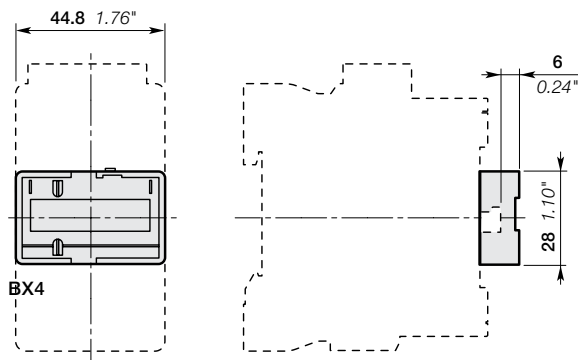

# Other accessories



2

BP38-4



BDT4  
For AF09 ... AF65, NF



BDT4  
For AF80 ... AF96

## Ordering details

For contactors	Catalog number	Global reference code	Pkg qty	Weight (1 pce)
				kg

## Mounting pieces

Mounting piece for replacing A Line contactors mounted by screws with AF Range contactors.

From contactor	To contactor				
A26 ... A40, AL26 ... AL40	AF09 ... AF38	BP38-4	1SBN112303T1000	10	0.003
A40 ... A75, AE50 ... AE75, AF50 ... AF75	AF40 ... AF65	BP65-4	1SBN113403T1000	10	0.004
A95, A110, AE95, AE110, AF95, AF110	AF80 ... AF96	BP96-4	1SBN113903T1000	10	0.005

## Test block

BDT4 test block is suitable for switching on contactor off-load.

Marking on the block indicates the contactor type to fit with.

AF09 ... AF96, NF	BDT4	1SBN110122T1000	10	0.007
-------------------	------	-----------------	----	-------

## Main dimensions mm, inches

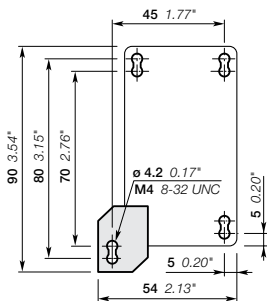

BP38-4

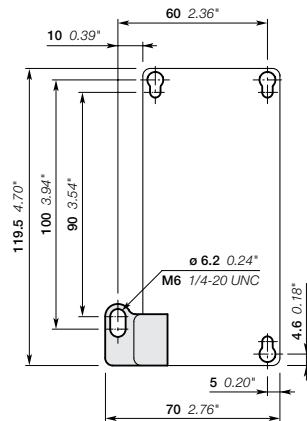

BP65-4

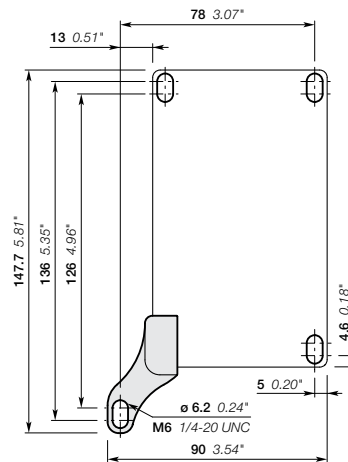

BP96-4



# Terminal shrouds and mechanical lugs



LT140-30L



LT370-30C



LT460-AC



ATK185

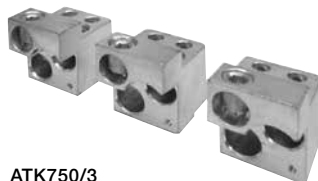

ATK750/3

## Description

Main terminal protection for AF116 ... AF1250 contactors.

The auxiliary contact blocks and coils are designed to provide an IP 20 degree of protection.

The main terminals, equipped with compression lugs or cable clamps, can be protected against accidental direct contact after wiring (EN 50274) by the addition of terminal shrouds (see table below).

## Ordering details

For contactors	Catalog number	Global reference code	Pkg qty	Weight (1 pce) kg
AF116 ... AF146, with compression lugs	LT140-30L	1SFN124203R1000	2	0.070
AF190, AF205, with cable clamps	LT205-30C	1SFN124801R1000	2	0.050
AF190, AF205, with compression lugs	LT205-30L	1SFN124803R1000	2	0.220
AF190, AF205, with shorting bar or between contactor and TOL/EOL in DOL starters	LT205-30Y	1SFN124804R1000	1	0.050
AF265 ... AF370, with cable clamps	LT370-30C	1SFN125401R1000	2	0.035
AF265 ... AF370, with compression lugs	LT370-30L	1SFN125403R1000	2	0.280
AF265 ... AF370, with shorting bar or between contactor and TOL/EOL in DOL starters	LT370-30Y	1SFN125404R1000	1	0.075
AF265 ... AF370, for use with extending cable clamps, ATK300/2 and OZXB4	LT370-30D	1SFN125406R1000	1	0.15
AF400, AF460 with cable clamps	LT460-AC	1SFN125701R1000	2	0.100
AF400, AF460 with compression lugs	LT460-AL	1SFN125703R1000	2	0.800
AF580, AF750 with cable clamps	LT750-AC	1SFN126101R1000	2	0.120
AF580, AF1250 with compression lugs	LT750-AL	1SFN126103R1000	2	0.825

## Description

Large contactors (AF190 and above) include bar terminals as standard to easily facilitate the use of busbar as a means of internal wiring. Mechanical lugs are a common solution for allowing the use of stranded or solid wire, and are widely utilized for field wiring termination.

## Ordering details

For contactors (1)	Description	Catalog number	Global reference code	Pkg qty	Weight (1 pce) kg
AF190, AF205	Lug kit, 1-wire, 4 AWG ... 300 MCM	ATK185	(2)	3	0.164
AF265 ... AF370	Lug kit, 1-wire, 4 AWG ... 400 MCM	ATK300	(2)	3	0.166
AF265 ... AF370	Lug kit, 2-wire, 4 AWG ... 500 MCM	ATK300/2	(2)	3	0.445
AF400 ... AF580	Lug kit, 2-wire, 2/0 AWG ... 500 MCM	ATK580/2	(2)	3	0.345
AF580, AF750	Lug kit, 3-wire, 2/0 AWG ... 500 MCM	ATK750/3	(2)	3	1.071
AF1350	Lug kit, 4-wire, 4/0 AWG ... 500 MCM (3)	ATK1350/4	(2)	3	1.883
AF1350, AF1650	Lug kit, 4-wire, 1/0 AWG ... 750 MCM (3)	ATK1650/4	(2)	3	3.353
AF1350, AF1650	Lug kit, 6-wire, 1/0 AWG ... 750 MCM (3)	ATK1650/6	(2)	3	4.378
AF190, AF205	Spare terminal hardware	LE185	1SFN074716R1000	1 set	0.200
AF265 ... AF370	Spare terminal hardware	LE300	1SFN075116R1000	1 set	0.300
AF400 ... AF580	Spare terminal hardware	LE460	1SFN075716R1000	1 set	0.600
AF580, AF750	Spare terminal hardware	LE750	1SFN076116R1000	1 set	0.750

(1) Note: AF1250, AF2050 & AF2650 intended for busbar connection only and terminal hardware is intended to be sourced separately.

(2) North American applications only.

(3) Note: Use of lug kits for AF1350 & AF1650 in general use applications reduces the ratings to 1050A and 1350A respectively. Recommend busbar connection for full ratings.

# Terminal enlargements and extensions

2



LW140

## Terminal enlargements

### Description

Enlargement pieces designed to increase the width of the contactor terminal pads in order to allow larger connections to be mounted.

### Ordering details

For contactors	Dimensions		Catalog number	Global reference code	Pkg qty	Weight (1 pce)
	hole Ø mm	bar mm				
AF116 ... AF146	6.5	13 x 3	LW140	1SFN074207R1000	1	0.115
AF190, AF205	10.5	17.5 x 5	LW205	1SFN074807R1000	1	0.260
AF265 ... AF370	10.5	20 x 5	LW370	1SFN075407R1000	1	0.340
AF400, AF460	10.5	25 x 5	LW460	1SFN075707R1000	1	0.730
AF580, AF750	13	40 x 6	LW750	1SFN076107R1000	1	1.230
AF1250	13	50 x 10	LW1250	1SFN076407R1000	1	2.000



LX140

## Terminal extension

### Description

Extension pieces designed to extend the main terminals of contactors for combined mounting of contactors and connection sets.

### Ordering details

For contactors	Dimensions		Catalog number	Global reference code	Pkg qty	Weight (1 pce)
	hole Ø mm	bar mm				
AF116 ... AF146	6.5	13 x 3	LX140	1SFN074210R1000	1	0.072
AF190, AF205	8.5	17.5 x 5	LX205	1SFN074810R1000	1	0.180
AF265 ... AF370	10.5	20 x 5	LX370	1SFN075410R1000	1	0.234
AF400, AF460	10.5	25 x 5	LX460	1SFN075710R1000	1	0.500
AF580, AF750	13	40 x 6	LX750	1SFN076110R1000	1	0.850

## Connection module

### Description

Connection module can be fixed on AF116 ... AF146 delivered with bar terminals.



LD146-30

### Ordering details

For contactor	Catalog number	Global reference code	Pkg qty	Weight (1 pce)
AF116 ... AF146	LD146-30	1SFN074208R1000	2	0.165

# Terminal connecting strips and shorting bars



LY16-4



LY185



LH38-4



LF16-4



LG16-4

## Description

Parallel and series connection of 3-pole contactors:

To obtain a star point (3 parallel-connected poles)

To connect poles in parallel and thus increase the AC load passing through the flow path made up of the parallel-connected poles: LP, LY, LH, LF, LG.

The relevant cable cross-sectional area may limit the maximum permissible current. Consult information in table below

To connect poles in series and thus increase the DC load controlled by the poles: LP, LY (only LY16-4 and LY38-4 selectable strips).

Types	for connection of "n" poles	with terminal	insulated
LP	n = 2	no	no (1)
LY	n = 2 (selectable LY16-4, LY38-4 connecting strips)	no	yes
	n = 3	no	yes (1)
LH	n = 2	yes	no
LF	n = 3	yes	yes
LG	n = 4	yes	yes

(1) LP460 ... LP750, LY185 ... LY750 not insulated. Use terminal shrouds.

## Ordering details

For contactors	max. nominal continuous current with "n" poles				Cable cross-sectional area mm <sup>2</sup>	Catalog number	Global reference code	Pkg qty	Weight (1 pce) kg
	in parallel		in series						
	2 poles	3 poles	4 poles	2 poles					
	<b>A</b>								
AF09	30	33	-	25	6	LY16-4	1SBN071303T1000	10	0.006
AF12	32	36	-	27					
AF16	34	40	-	30					
AF26	50	60	-	45	10	LY38-4	1SBN072303T1000	10	0.012
AF116 ... AF146	-	240	-	-	-	LY140	1SBN074203R1000	1	0.055
AF190, AF205	-	400	-	-	-	LY185	1SBN074703R1000	1	0.200
AF265 ... AF370	-	670	-	-	-	LY300	1SBN075103R1000	1	0.300
AF400, AF460	-	1000	-	-	-	LY460	1SBN075703R1000	1	0.450
AF580, AF750	-	1650	-	-	-	LY750	1SBN076103R1000	1	0.800
AF190, AF205	300	-	-	-	-	LP185	1SBN074712R1000	2	0.300
AF265 ... AF370	475	-	-	-	-	LP300	1SBN075112R1000	2	0.400
AF400, AF460	725	-	-	-	-	LP460	1SBN075712R1000	2	0.550
AF580, AF750	1200	-	-	-	-	LP750	1SBN076112R1000	2	0.950
AF09	45	-	-	-	10	LH38-4	1SBN072304R1000	2	0.012
AF12	50	-	-	-	10				
AF16	54	-	-	-	16				
AF26	81	-	-	-	25				
AF30, AF38	90	-	-	-	25				
AF09	-	62	-	-	16	LF16-4	1SBN071305R1000	2	0.020
AF12	-	70	-	-	25				
AF16	-	75	-	-	25				
AF26	-	112	-	-	35	LF38-4	1SBN072305R1000	2	0.040
AF30, AF38	-	125	-	-	50				
AF09	-	-	70	-	25	LG16-4	1SBN071306R1000	2	0.025
AF12	-	-	78	-	25				
AF16	-	-	84	-	25				

## Main dimensions

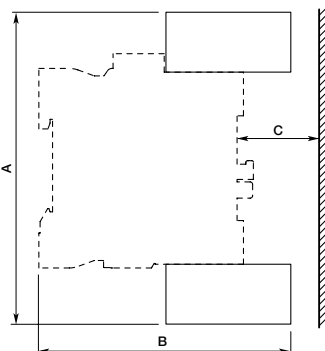

Type	For contactors	Dimensions					
		A		B		C	
		mm	inch	mm	inch	mm	inch
LH38-4	AF09 ... AF16	111.20	4.38"	83	3.27"	22	0.87"
	AF26 ... AF38	114	4.49"	86	3.39"	16	0.63"
LF16-4	AF09 ... AF16	121	4.76"	87	3.43"	23	0.91"
LF38-4	AF26 ... AF38	135.20	5.32"	103	4.06"	31	1.22"
LG16-4	AF09 ... AF16	124.20	4.89"	87	3.43"	23	0.91"

# Reversing and phase-to-phase bus kits

2

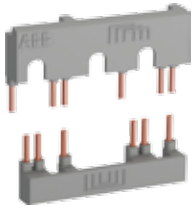

BER16-4

## Connection sets for reversing contactors

### Description

The BER and BEM connection sets are used to connect the main poles of two 3-pole contactors mounted side by side.

The BER connection sets are made up of 1 upstream and 1 downstream connections.

The BEM connection sets are made up of 3 upstream and 3 downstream connections.

BER and BEM connection sets are insulated and made of solid copper bars.

### Ordering details

For 3-pole contactors	Catalog number	Global reference code	Pkg qty	Weight (1 pce) kg
AF09 ... AF16	BER16-4	1SBN081311R1000	1	0.045
AF26 ... AF38	BER38-4	1SBN082311R1000	1	0.100
AF40 ... AF65	BER65-4	1SBN083411R1000	1	0.175
AF80, AF96	BER96-4	1SBN083911R1000	1	0.250
AF116 ... AF146	BER140-4	1SFN084211R1000	1	0.615
AF190, AF205	BER205-4	1SFN084811R1000	1	1.237
AF265 ... AF370	BER370-4	1SFN085411R1000	1	2.140
AF400, AF460	BEM460-30	1SFN085701R1000	1	4.400
AF580, AF750	BEM750-30	1SFN086101R1000	1	7.300

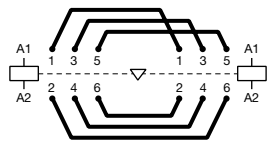

BER, BEM  
Reversing connections



BEP140-30

## 3-pole phase to phase connections

### Description

The BEP and BES connection sets are used to connect phase to phase the main poles of two 3-pole contactors mounted side by side.

The BEP connection sets are made up of 1 upstream or downstream connections.

The BES connection sets are made up of 3 upstream or downstream connections.

BEP and BES connection sets are insulated and made of solid copper bars.

### Ordering details

For 3-pole contactors	Catalog number	Global reference code	Pkg qty	Weight (1 pce) kg
AF116 ... AF146	BEP140-30	1SFN084214R1000	1	0.320
AF190, AF205	BEP205-30	1SFN084814R1000	1	0.534
AF265 ... AF370	BEP370-30	1SFN085414R1000	1	0.926
AF400, AF460	BES460	1SFN085704R1000	1	2.200
AF580, AF750	BES750	1SFN086104R1000	1	3.700

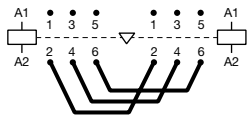

BEP, BES  
Phase to phase connections

# Wye-delta bus kits

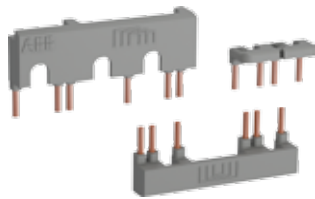

BEY16-4

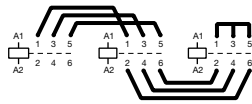

AF09 ... AF750  
1M - 2M -1S

## Description

The BEY and BED connection sets are used to connect the main poles of the Line, Delta and Wye contactors of a wye-delta starter.

The connection sets are made up of:

- Line contactor / delta contactor:
  - BEY: upstream phase-to-phase connection
  - BED: upstream connection in parallel
- Delta contactor / Wye contactor: downstream connection in parallel
- Wye contactor: Wye point upstream
- Insulated, solid copper bar.

## Ordering details

For 3-pole line, delta & wye contactors	Interlock unit between delta & wye contactors	Catalog number	Global reference code	Pkg qty	Weight (1 pce) kg
AF09 ... AF16	With or without VM4 or VEM4	BEY16-4	1SBN081313R2000	1	0.050
AF26 ... AF38	With or without VM4 or VEM4	BEY38-4	1SBN082713R2000	1	0.110
AF40 ... AF65	With or without VM96-4	BEY65-4	1SBN083413R2000	1	0.200
AF80, AF96	With or without VM96-4	BEY96-4	1SBN083913R2000	1	0.250
AF116 ... AF146	With or without VM19	BEY140-4	1SFN084413R1000	1	1.040
AF190 ... AF205 (line and delta) AF140 ... AF146 (wye)	With or without VM140/190	BEY190-4	1SFN084813R1000	1	1.154
AF190, AF205	With or without VM19	BEY205-4	1SFN085213R1000	1	1.205
AF265 ... AF370 (line and delta) AF190 ... AF205 (wye)	With or without VM205/265	BEY265-4	1SFN085413R1000	1	2.020
AF265 ... AF370	With or without VM19	BEY370-4	1SFN085813R1000	1	2.110
AF400 ... AF460	With or without VM750H	BED460U	-	1	4.700
AF580 ... AF750 (line and delta) AF400 ... AF460 (wye)	With or without VM750H	BED580U	-	1	6.300
AF580 ... AF750	With or without VM750H	BED750U	-	1	7.700

# Coupling units

2

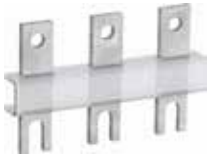

BEA140/XT2



BEA205/T4



BEA370/T5

## Connection bars between contactors and MCCB

### Description

Connection between contactors/starters and moulded case circuit breakers.  
These connection sets are solid copper bars.

### Ordering details

For contactors	MCCB	Catalog number	Global reference code	Pkg qty	Weight (1 pce) kg
<b>Vertical assembly</b>					
AF116 ... AF146	XT2	BEA140/XT2	1SFN084206R1000	1	0.058
AF116 ... AF146	XT4	BEA140/XT4	1SFN084206R1001	1	0.068
AF190, AF205	XT4	BEA205/XT4	1SFN084806R1000	1	0.200
AF190, AF205	T4	BEA205/T4	1SFN084806R1001	1	0.190
AF265 ... AF370	T5	BEA370/T5	1SFN085406R1000	1	0.350
AF400 ... AF750	T6	BEA750/T6	1SFN086106R1000	1	0.410
AF400 ... AF750	T5	BEA750/T5	1SFN086106R1001	1	0.410
<b>Vertical assembly with control wire terminals</b> (also suitable when using busbar kits for starter combinations)					
AF400 ... AF750	T5	BEA750D/T5	1SFN086106R1003	1	0.720
AF400 ... AF750	T6	BEA750D/T6	1SFN086106R1002	1	0.720
<b>Horizontal assembly</b> (also suitable when using busbar kits for starter combinations)					
AF400, AF460	T4	BEA460H/T4	1SFN085907R1000	1	2.450

## Connection bars between contactors and fusible disconnects

### Description

Connection between contactors/starters and fusible disconnect switches.  
These connection sets are solid copper bars.

### Ordering details

For contactors	Switch fuse	Catalog number	Global reference code	Pkg qty	Weight (1 pce) kg
<b>Vertical assembly</b>					
AF400, AF460	OESA400	BEF460/OESA400	1SFN085708R1000	1	0.340
AF460 ... AF750	OESA630 to OESA800	BEF750/OESA800	1SFN086108R1000	1	0.740
<b>Horizontal assembly</b>					
AF400, AF460	OESA400...LR	OESA460H/OESA400	1SFN085709R1000	1	1.250

Note: The BEF connection bars provided for the A145 ... A300 contactors can be used for the AF145 ... AF300 contactors.

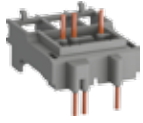

BEA16-4

## Connecting links with manual motor starters

### Description

The BEA insulated 3-pole connecting links are used to connect AF09 ... AF38 contactors with the MS116 or MS132 manual motor starters. The BEA insulated 3-pole connecting links ensure the electrical and mechanical connection between the contactor and the associated manual motor starter.

### Ordering details

For 3-pole contactors	Manual motor starter	Catalog number	Global reference code	Pkg qty	Weight (1 pce) kg
AF09 ... AF16	MS116-0.16 ... MS116-25, MS132-0.16... MS132-25	BEA16-4	1SBN081306T1000	10	0.025
AF26 ... AF38	MS116-0.16 ... MS116-16, MS132-0.16 ... MS132-10	BEA26-4	1SBN082306T1000	10	0.025
	MS116-20 ... MS116-32, MS132-12 ... MS132-32	BEA38-4	1SBN082306T2000	10	0.030

# Mounting plates

2



PN460

## Description

Mounting plates with fixing holes for the specified contactors and overload relays.

## Ordering details

For contactors	For overload relays	Catalog number	Global reference code	Pkg qty	Weight (1 pce)
					kg

### Mounting plates for Direct on line starters

AF400, AF460	E500DU	PN460-11	1SFN095705R1000	1	2.120
AF580, AF750	E800DU	PN750-11	1SFN096105R1000	1	2.500

For two contactors side by side with space for mechanical interlock	For one or two overload relays	Catalog number	Global reference code	Pkg qty	Weight (1 pce)
					kg

### Mounting plates for mechanical interlocked contactors, reversing starters and two speed starters for double windings

AF400, AF460	E500DU	PN460-21	1SFN095701R1000	1	3.490
AF580, AF750	E800DU	PN750-21	1SFN096101R1000	1	4.230

For main and delta contactors	For wye contactor (1)	For overload relays	Catalog number	Global reference code	Pkg qty	Weight (1 pce)
						kg

### Mounting plates for wye-delta starters and two speed starters for single windings

AF400, AF460	A300, AF400	E500DU	PN460-41	1SFN095703R1000	1	5.310
AF580, AF750	AF400 ... AF580	E800DU	PN750-41	1SFN096103R1000	1	6.320

(1) Space for mechanical interlock included.



# Adapter plates

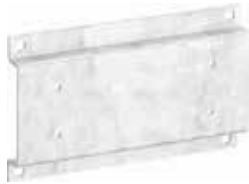

PR146-1

## Description

Adapter plates with fixing holes for replacing installed contactors.

## Ordering details

From contactors	To contactor	Catalog number	Global reference code	Pkg qty	Weight (1 pce)
A95, AF95, A110, AF110	AF116, AF140, AF146	PR146-1	1SFN094200R1000	1	0.300
EH150, EH160, EH175, EH210, EG160	AF190, AF205	PR210-1	1SFN094900R1000	1	0.440
EH250, EH260, EH300	AF265, AF305, AF370	PR300-1	1SFN095300R1000	1	0.560
EH370, EH550, EG315	AF400, AF460, AF580	PR460-1	1SFN095700R1000	1	0.900
EH700, EH800	AF750	PR750-1	1SFN096100R1000	1	0.500
OKYM150, OKYM175	AF190	PR185-2	1SFN095100R1001	1	0.500
OKYM200, OKYM250	AF265, AF305, AF370	PR300-2	1SFN095300R1001	1	0.500
OKYM315	AF400, AF460	PR400-2	1SFN095700R1002	1	0.820
OKYM400	AF400, AF460	PR460-2	1SFN095700R1001	1	0.800
OKYM500	AF580	PR580-2	1SFN096100R1002	1	0.700
EH550, EG630, OKYM630	AF580, AF750	PR750-2	1SFN096100R1001	1	1.100

Note: for smaller devices, see mounting pieces on the other accessories page.

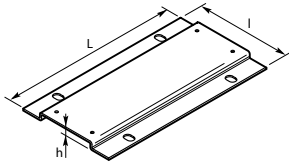

## Dimensions (mm)

Type of the plate	Dimensions			Fixing holes
	L	l	h	mm
PR146-1	150	90	15	4 x $\varnothing$ 6.5
PR210-1	200	132	11.5	4 x $\varnothing$ 7
PR300-1	200	172	11.5	4 x $\varnothing$ 7
PR460-1	278	198	11.5	4 x $\varnothing$ 7
PR750-1	283	244	11.5	4 x $\varnothing$ 7
PR185-2	202	152	11.2	4 x $\varnothing$ 11
PR300-2	202	152	11.2	4 x $\varnothing$ 11
PR400-2	278	151	11.5	4 x $\varnothing$ 11
PR460-2	278	176	11.5	4 x $\varnothing$ 11
PR580-2	283	176	11.5	4 x $\varnothing$ 11
PR750-2	283	255	11.5	4 x $\varnothing$ 14

Fixing holes according to the plate types

# Service parts

## Contactor coils, main contact sets and arc chutes

2



ZAF1650

### Contactor coils

#### Ordering details

For contactors	Rated control circuit voltage Uc min. ... Uc max.		Catalog number	Global reference code	Pkg qty	Weight (1 pce) kg
	V 50/60 Hz	V DC				
AF400, AF460	-	24...60	ZAF460-68	1SFN155770R6806	1	0.525
	48...130	48...130	ZAF460-69	1SFN155770R6906	1	0.525
	100...250	100...250	ZAF460-70	1SFN155770R7006	1	0.525
	250...500	250...500	ZAF460-71	1SFN155770R7106	1	0.525
AF580 ... AF1250	-	24...60	ZAF750-68	1SFN156170R6806	1	1.335
	48...130	48...130	ZAF750-69	1SFN156170R6906	1	1.335
	100...250	100...250	ZAF750-70	1SFN156170R7006	1	1.335
	250...500	250...500	ZAF750-71	1SFN156170R7106	1	1.335
AF1350 ... AF2050	100...250	100...250	ZAF1650-70 (1)	1SFN156570R7026	1 set	0.900
			ZP1650 (2)	1SFN166521R1070	1	0.300
AF2650	100...250	100...250	ZAF2650-70 (1)	1SFN156670R7026	1 set	0.900
			ZP2650 (2)	1SFN166621R1070	1	0.300

(1) One set of two coil.  
(2) Printed circuit board.

### Main contact sets

#### Description

The contact sets for 3-pole contactors consists of six fixed contacts, three moving contacts, springs and the required screws.

#### Ordering details

For contactors	Catalog number	Global reference code	Pkg qty	Weight (1 pce) kg
AF400	ZL400	1SFN165703R1000	1 set	1.320
AF460	ZL460	1SFN165903R1000	1 set	1.320
AF580	ZL580	1SFN166103R1000	1 set	1.840
AF750	ZL750	1SFN166303R1000	1 set	1.840
AF1250	ZL1250	1SFN166403R1000	1 set	1.840
AF1350 (1)	ZL1350	1SFN166503R1000	1 set	2.500
AF1650 (1)	ZL1650	1SFN166703R1000	1 set	3.500
AF2050 (1)	ZL2050	1SFN167003R1000	1 set	3.500
AF2650 (2)	ZL2650	1SFN166603R1000	1 set	1.200

(1) Six fixed, three moving contacts per each power pole.  
(2) Moving contacts only.

### Arc chutes

#### Description

The arc chute sets for 3-pole contactors include six arc chutes, two for each power pole.

#### Ordering details

For contactors	Catalog number	Global reference code	Pkg qty	Weight (1 pce) kg
AF400, AF460	ZW460	1SFN165710R1000	1 set	1.380
AF580, AF750, AF1250	ZW750	1SFN166110R1000	1 set	1.500
AF1350, AF1650, AF2050	ZW1650	1SFN166510R1000	1 set	4.000
AF2650	ZW2650	1SFN166610R1000	1 set	4.000

# AF09 ... AF38 3-pole contactors

## Technical data

### Main pole - Utilization characteristics according to IEC

Contactors types	AC / DC operated	AF09	AF12	AF16	AF26	AF30	AF38
Standards		IEC 60947-1 / 60947-4-1 and EN 60947-1 / 60947-4-1					
Rated operational voltage U <sub>e</sub> max.		690 V					
Rated frequency (without derating)		50 / 60 Hz					
Conventional free-air thermal current I <sub>th</sub>							
acc. to IEC 60947-4-1, open contactors, $\theta \leq 40\text{ }^\circ\text{C}$		35 A	35 A	35 A	50 A	50 A	50 A
With conductor cross-sectional area		6 mm <sup>2</sup>	6 mm <sup>2</sup>	6 mm <sup>2</sup>	10 mm <sup>2</sup>	10 mm <sup>2</sup>	10 mm <sup>2</sup>
<b>AC-1 Utilization category</b>							
For air temperature close to contactor							
<b>I<sub>e</sub> / Rated operational current AC-1</b>	$\theta \leq 40\text{ }^\circ\text{C}$	25 A	28 A	30 A	45 A	50 A	50 A
U <sub>e</sub> max. $\leq 690\text{ V}$ , 50/60 Hz	$\theta \leq 60\text{ }^\circ\text{C}$	25 A	28 A	30 A	40 A	42 A	42 A
	$\theta \leq 70\text{ }^\circ\text{C}$	22 A	24 A	26 A	32 A	37 A	37 A
With conductor cross-sectional area		4 mm <sup>2</sup>	6 mm <sup>2</sup>	6 mm <sup>2</sup>	10 mm <sup>2</sup>	10 mm <sup>2</sup>	10 mm <sup>2</sup>
<b>AC-3 Utilization category</b>							
For air temperature close to contactor $\theta \leq 60\text{ }^\circ\text{C}$							
<b>I<sub>e</sub> / Max. rated operational current AC-3 (1)</b>							
	220-230-240 V	9 A	12 A	18 A	26 A	33 A	40 A
	380-400 V	9 A	12 A	18 A	26 A	32 A	38 A
	415 V	9 A	12 A	18 A	26 A	32 A	38 A
	440 V	9 A	12 A	18 A	26 A	32 A	38 A
	500 V	9,5 A	12,5 A	15 A	23 A	28 A	33 A
	690 V	7 A	9 A	10,5 A	17 A	21 A	24 A
<b>Rated operational power AC-3 (1)</b>							
	220-230-240 V	2,2 kW	3 kW	4 kW	6,5 kW	9 kW	11 kW
	380-400 V	4 kW	5,5 kW	7,5 kW	11 kW	15 kW	18,5 kW
	415 V	4 kW	5,5 kW	9 kW	11 kW	15 kW	18,5 kW
	440 V	4 kW	5,5 kW	9 kW	15 kW	18,5 kW	22 kW
	500 V	5,5 kW	7,5 kW	9 kW	15 kW	18,5 kW	22 kW
	690 V	5,5 kW	7,5 kW	9 kW	15 kW	18,5 kW	22 kW
<b>Rated making capacity AC-3</b>		10 x I <sub>e</sub> AC-3 acc. to IEC 60947-4-1					
<b>Rated breaking capacity AC-3</b>		8 x I <sub>e</sub> AC-3 acc. to IEC 60947-4-1					
<b>AC-8a Utilization category</b>							
(without thermal overload relay - U <sub>e</sub> 400 V 50/60 Hz - $\theta \leq 40\text{ }^\circ\text{C}$ )							
<b>I<sub>e</sub> / Rated operational current AC-8a</b>		12 A	16 A	22 A	30 A	40 A	50 A
<b>Rated operational power AC-8a</b>		5,5 kW	7,5 kW	11 kW	15 kW	20 kW	25 kW
<b>Short-circuit protection device for contactors</b>							
without thermal overload relay - Motor protection excluded (2)							
U <sub>e</sub> $\leq 500\text{ V AC}$ - gG type fuse		25 A	32 A	32 A	50 A	63 A	63 A
<b>Rated short-time withstand current I<sub>cw</sub></b>							
at 40 °C ambient temperature, in free air from a cold state							
	1 s	300 A	300 A	300 A	700 A	700 A	700 A
	10 s	150 A	150 A	150 A	350 A	350 A	350 A
	30 s	80 A	80 A	80 A	225 A	225 A	225 A
	1 min	60 A	60 A	60 A	150 A	150 A	150 A
	15 min	35 A	35 A	35 A	50 A	50 A	50 A
<b>Maximum breaking capacity</b>							
cos $\phi = 0,45$							
	at 440 V	250 A	250 A	250 A	500 A	500 A	500 A
	at 690 V	106 A	106 A	106 A	200 A	200 A	200 A
<b>Power dissipation per pole</b>							
	I <sub>e</sub> / AC-1	0,8 W	1 W	1,2 W	1,8 W	2,4 W	2,4 W
	I <sub>e</sub> / AC-3	0,1 W	0,2 W	0,35 W	0,6 W	0,9 W	1,3 W
<b>Max. electrical switching frequency</b>							
	AC-1	600 cycles/h					
	AC-3	1200 cycles/h					
	AC-2, AC-4	300 cycles/h			150 cycles/h		



(1) For the corresponding kW/A or hp/A values of 1500 r.p.m, 50 Hz or 1800 r.p.m, 60 Hz, 3-phase motors, see "Motor rated operational powers and currents".

(2) For the protection of motor starters against short circuits, see "Coordination with short-circuit protection devices".

# AF40 ... AF96 3-pole contactors

## Technical data

### Main pole - Utilization characteristics according to IEC

Contactor types	AC / DC operated	AF40	AF52	AF65	AF80	AF96	
Standards		IEC 60947-1 / 60947-4-1 and EN 60947-1 / 60947-4-1					
Rated operational voltage $U_e$ max.		690 V					
Rated frequency (without derating)		50 / 60 Hz					
Conventional free-air thermal current $I_{th}$ acc. to IEC 60947-4-1, open contactors, $\theta \leq 40^\circ\text{C}$ With conductor cross-sectional area		105 A	105 A	105 A	130 A	130 A	
		35 mm <sup>2</sup>	35 mm <sup>2</sup>	35 mm <sup>2</sup>	50 mm <sup>2</sup>	50 mm <sup>2</sup>	
<b>AC-1 Utilization category</b>							
For air temperature close to contactor							
$I_e$ / Rated operational current AC-1 $U_e$ max. $\leq 690$ V, 50/60 Hz	$\theta \leq 40^\circ\text{C}$	70 A	100 A	105 A	125 A	130 A	
	$\theta \leq 60^\circ\text{C}$	60 A	80 A	90 A	100 A	105 A	
	$\theta \leq 70^\circ\text{C}$	50 A	70 A	80 A	85 A	90 A	
With conductor cross-sectional area		25 mm <sup>2</sup>	35 mm <sup>2</sup>	35 mm <sup>2</sup>	50 mm <sup>2</sup>	50 mm <sup>2</sup>	
<b>AC-3 Utilization category</b>							
For air temperature close to contactor $\theta \leq 60^\circ\text{C}$							
$I_e$ / Max. rated operational current AC-3 (1)	220-230-240 V	40 A	53 A	65 A	80 A	96 A	
	380-400 V	40 A	53 A	65 A	80 A	96 A	
 3-phase motors	415 V	40 A	53 A	65 A	80 A	96 A	
	440 V	40 A	53 A	65 A	80 A	96 A	
	500 V	35 A	45 A	55 A	65 A	80 A	
	690 V	25 A	35 A	39 A	49 A	57 A	
	<b>Rated operational power AC-3 (1)</b>						
	220-230-240 V	11 kW	15 kW	18.5 kW	22 kW	25 kW	
 1500 r.p.m. 50 Hz 1800 r.p.m. 60 Hz 3-phase motors	380-400 V	18.5 kW	22 kW	30 kW	37 kW	45 kW	
	415 V	22 kW	30 kW	37 kW	45 kW	55 kW	
	440 V	22 kW	30 kW	37 kW	45 kW	55 kW	
	500 V	22 kW	30 kW	37 kW	45 kW	55 kW	
	690 V	22 kW	30 kW	37 kW	45 kW	55 kW	
	<b>Rated making capacity AC-3</b>						
10 x $I_e$ AC-3 acc. to IEC 60947-4-1							
<b>Rated breaking capacity AC-3</b>							
8 x $I_e$ AC-3 acc. to IEC 60947-4-1							
<b>AC-8a Utilization category</b>							
(without thermal overload relay - $U_e$ 400 V 50/60 Hz - $\theta \leq 40^\circ\text{C}$ )							
$I_e$ / Rated operational current AC-8a		53 A	70 A	85 A	105 A	120 A	
	Rated operational power AC-8a	25 kW	37 kW	45 kW	55 kW	65 kW	
<b>Short-circuit protection device for contactors</b>							
without thermal overload relay - Motor protection excluded (2)							
$U_e \leq 500$ V AC - gG type fuse							
Rated short-time withstand current $I_{cw}$ at 40 °C ambient temperature, in free air from a cold state	1 s	1000 A	1000 A	1000 A	1200 A	1200 A	
	10 s	600 A	600 A	600 A	780 A	780 A	
	30 s	350 A	350 A	350 A	450 A	450 A	
	1 min	250 A	250 A	250 A	300 A	300 A	
	15 min	110 A	110 A	110 A	140 A	140 A	
<b>Maximum breaking capacity</b>							
$\cos \varphi = 0.45$							
	at 440 V	(3)					
	at 690 V	(3)					
Power dissipation per pole	$I_e$ / AC-1	3 W	6.3 W	7 W	7.6 W	8.2 W	
	$I_e$ / AC-3	1 W	1.7 W	2.7 W	3 W	4.5 W	
Max. electrical switching frequency	AC-1	600 cycles/h					
	AC-3	1200 cycles/h					
	AC-2, AC-4	150 cycles/h					

(1) For the corresponding kW/A or hp/A values of 1500 r.p.m, 50 Hz or 1800 r.p.m, 60 Hz, 3-phase motors, see "Motor rated operational powers and currents".

(2) For the protection of motor starters against short circuits, see "Coordination with short-circuit protection devices".

(3) On request.

# AF116 ... AF370 3-pole contactors

## Technical data

### Main pole - Utilization characteristics according to IEC

Contactor types	AC / DC operated	AF116	AF140	AF146	AF190	AF205	AF265	AF305	AF370
<b>Standards</b>		IEC 60947-1 / 60947-4-1 and EN 60947-1 / 60947-4-1							
<b>Rated operational voltage Ue max.</b>		690 V	690 V	1000 V	1000 V	1000 V	1000 V	1000 V	1000 V
<b>Rated frequency (without derating)</b>		50 / 60 Hz							
<b>Conventional free-air thermal current Ith</b>		160 A	200 A	225 A	275 A	350 A	400 A	500 A	600 A
acc. to IEC 60947-4-1, open contactors, $\theta \leq 40^\circ\text{C}$ With conductor cross-sectional area		70 mm <sup>2</sup>	95 mm <sup>2</sup>	95 mm <sup>2</sup>	150 mm <sup>2</sup>	240 mm <sup>2</sup>	240 mm <sup>2</sup> (3)	300 mm <sup>2</sup>	2 x 185 mm <sup>2</sup> (4)
<b>AC-1 Utilization category</b>									
For air temperature close to contactor									
<b>Ie / Rated operational current AC-1</b>	$\theta \leq 40^\circ\text{C}$	160 A	200 A	225 A	275 A	350 A	400 A	500 A	600 A
Ue max. $\leq 690\text{ V}$ , 50/60 Hz	$\theta \leq 60^\circ\text{C}$	145 A	175 A	200 A	250 A	300 A	350 A	400 A	500 A
	$\theta \leq 70^\circ\text{C}$	130 A	160 A	175 A	200 A	240 A	290 A	325 A	400 A
<b>Ie / Rated operational current AC-1</b>	$\theta \leq 40^\circ\text{C}$	—	—	225 A	250 A	275 A	350 A	375 A	400 A
Ue max. $\leq 1000\text{ V}$ , 50/60 Hz	$\theta \leq 60^\circ\text{C}$	—	—	200 A	225 A	250 A	300 A	325 A	350 A
	$\theta \leq 70^\circ\text{C}$	—	—	175 A	185 A	200 A	240 A	260 A	290 A
With conductor cross-sectional area		70 mm <sup>2</sup>	95 mm <sup>2</sup>	95 mm <sup>2</sup>	150 mm <sup>2</sup>	240 mm <sup>2</sup>	240 mm <sup>2</sup> (3)	300 mm <sup>2</sup>	2 x 185 mm <sup>2</sup> (4)
<b>AC-3 Utilization category</b>									
For air temperature close to contactor $\theta \leq 60^\circ\text{C}$									
<b>Ie / Max. rated operational current AC-3 (1)</b>									
	220-230-240 V	116 A	140 A	146 A	190 A	205 A	265 A	305 A	370 A
	380-400 V	116 A	140 A	146 A	190 A	205 A	265 A	305 A	370 A
	415 V	116 A	140 A	146 A	190 A	205 A	265 A	305 A	370 A
	440 V	116 A	140 A	146 A	190 A	205 A	265 A	305 A	370 A
	500 V	110 A	130 A	130 A	160 A	185 A	260 A	290 A	350 A
	690 V	65 A	80 A	93 A	135 A	165 A	250 A	290 A	315 A
	1000 V	—	—	60 A	85 A	100 A	100 A	100 A	100 A
<b>Rated operational power AC-3 (1)</b>									
	220-230-240 V	30 kW	37 kW	45 kW	55 kW	55 kW	75 kW	90 kW	110 kW
	380-400 V	55 kW	75 kW	75 kW	90 kW	110 kW	132 kW	160 kW	200 kW
	415 V	55 kW	75 kW	75 kW	90 kW	110 kW	132 kW	160 kW	200 kW
	440 V	75 kW	90 kW	90 kW	110 kW	132 kW	160 kW	160 kW	200 kW
	500 V	75 kW	90 kW	90 kW	110 kW	132 kW	160 kW	200 kW	250 kW
	690 V	55 kW	75 kW	90 kW	132 kW	160 kW	200 kW	250 kW	315 kW
	1000 V	—	—	75 kW	110 kW	132 kW	132 kW	132 kW	132 kW
<b>Rated making capacity AC-3</b>		10 x Ie AC-3 acc. to IEC 60947-4-1							
<b>Rated breaking capacity AC-3</b>		8 x Ie AC-3 acc. to IEC 60947-4-1							
<b>Short-circuit protection device for contactors</b>									
without thermal overload relay - Motor protection excluded (2)									
Ue $\leq 500\text{ V}$ AC - gG type fuse		250 A	315 A	315 A	355 A	400 A	500 A	500 A	630 A
<b>Rated short-time withstand current Icw</b>	1 s	1300 A	1460 A	1460 A	1900 A	2050 A	2650 A	3050 A	3700 A
at 40 °C ambient temperature,	10 s	928 A	1168 A	1168 A	1520 A	1640 A	2120 A	2440 A	2960 A
in free air from a cold state	30 s	536 A	674 A	674 A	878 A	947 A	1224 A	1409 A	1709 A
	1 min	379 A	477 A	477 A	621 A	670 A	865 A	996 A	1208 A
	15 min	160 A	200 A	225 A	275 A	350 A	400 A	500 A	600 A
<b>Maximum breaking capacity</b>									
$\cos \varphi = 0.45$	at 440 V	2000 A	3000 A	3000 A	3300 A	3500 A	3800 A	4600 A	5000 A
( $\cos \varphi = 0.35$ for Ie > 100 A)	at 690 V	1000 A	1500 A	1500 A	2200 A	2500 A	3300 A	3800 A	4000 A
<b>Power dissipation per pole</b>									
	Ie / AC-1	12 W	18 W	23 W	15 W	25 W	32 W	50 W	72 W
	Ie / AC-3	6 W	9 W	10 W	7 W	8 W	14 W	19 W	27 W
<b>Maximum electrical switching frequency</b>									
	AC-1	300 cycles/h							
	AC-3	300 cycles/h							
	AC-2, AC-4	150 cycles/h							

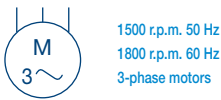

(1) For the corresponding kW/A or hp/A values of 1500 r.p.m, 50 Hz or 1800 r.p.m, 60 Hz, 3-phase motors, see "Motor rated operational powers and currents".  
 (2) For the protection of motor starters against short circuits, see "Coordination with short-circuit protection devices".  
 (3) For currents above 275A use terminal enlargements or terminal extensions.  
 (4) For currents above 450A use terminal enlargements or terminal extensions.

# AF400 ... AF2650 3-pole contactors

## Technical data

### Main pole - Utilization characteristics according to IEC

Contactor types	AC / DC operated	AF400	AF460	AF580	AF750	AF1250	AF1350	AF1650	AF2050	AF2650	
<b>Standards</b>		IEC 60947-1 / 60947-4-1 and EN 60947-1 / 60947-4-1									
<b>Rated operational voltage Ue max.</b>		1000 V									
<b>Rated frequency (without derating)</b>		50/60 Hz									
<b>Conventional free-air thermal current Ith</b>		acc. to IEC 60947-4-1, open contactors, $\theta \leq 40^\circ\text{C}$									
	With conductor cross-sectional area (3)	600 A	700 A	800 A	1050 A	1260 A	1350 A	1650 A	2050 A	2650 A	
		2x185 mm <sup>2</sup>	2x240 mm <sup>2</sup>	2x240 mm <sup>2</sup>	800 mm <sup>2</sup> (4)	1000 mm <sup>2</sup> (4)	1000 mm <sup>2</sup> (5)	1500 mm <sup>2</sup> (5)	2000 mm <sup>2</sup> (5)	3000 mm <sup>2</sup> (5)	
<b>AC-1 Utilization category</b>		For air temperature close to contactor									
	<b>Ie / Rated operational current AC-1</b>	$\theta \leq 40^\circ\text{C}$									
	Ue max. $\leq 690\text{ V}$ , 50/60 Hz	600 A	700 A	800 A	1050 A	1260 A	1350 A	1650 A	2050 A	2650 A	
		$\theta \leq 55^\circ\text{C}$									
		500 A	600 A	700 A	875 A	1040 A	1150 A	1450 A	1750 A	2350 A	
		$\theta \leq 70^\circ\text{C}$									
		400 A	480 A	580 A	720 A	875 A	1000 A	1270 A	1500 A	2120 A	
	<b>Ie / Rated operational current AC-1</b>	$\theta \leq 40^\circ\text{C}$									
	Ue max. $\leq 1000\text{ V}$ , 50/60 Hz	600 A	700 A	800 A	1000 A	1260 A	1350 A	1650 A	2050 A	2650 A	
		$\theta \leq 55^\circ\text{C}$									
		500 A	600 A	700 A	875 A	1040 A	1150 A	1450 A	1750 A	2350 A	
		$\theta \leq 70^\circ\text{C}$									
		400 A	480 A	580 A	720 A	875 A	1000 A	1270 A	1500 A	2120 A	
	With conductor cross-sectional area	2x185 mm <sup>2</sup>	2x240 mm <sup>2</sup>	2x240 mm <sup>2</sup>	800 mm <sup>2</sup> (4)	1000 mm <sup>2</sup> (4)	1000 mm <sup>2</sup> (5)	1500 mm <sup>2</sup> (5)	2000 mm <sup>2</sup> (5)	3000 mm <sup>2</sup> (5)	
<b>AC-3 Utilization category</b>		For air temperature close to contactor $\theta \leq 55^\circ\text{C}$									
	<b>Ie / Max. rated operational current AC-3 (1)</b>										
	<b>220-230-240 V</b>	400 A	460 A	580 A	750 A	-	860 A	1050 A	-	-	
	<b>380-400 V</b>	400 A	460 A	580 A	750 A	-	860 A	1050 A	-	-	
	<b>415 V</b>	400 A	460 A	580 A	750 A	-	860 A	1050 A	-	-	
	<b>440 V</b>	400 A	460 A	580 A	750 A	-	860 A	1050 A	-	-	
	<b>500 V</b>	400 A	460 A	580 A	750 A	-	800 A	950 A	-	-	
	<b>690 V</b>	350 A	400 A	500 A	650 A	-	800 A	950 A	-	-	
	<b>1000 V</b>	155 A	200 A	250 A	300 A	-	-	-	-	-	
	<b>Rated operational power AC-3 (1)</b>										
	<b>220-230-240 V</b>	110 kW	132 kW	160 kW	220 kW	-	257 kW	315 kW	-	-	
	<b>380-400 V</b>	200 kW	250 kW	315 kW	400 kW	-	475 kW	560 kW	-	-	
	<b>415 V</b>	220 kW	250 kW	355 kW	425 kW	-	500 kW	600 kW	-	-	
	<b>440 V</b>	220 kW	250 kW	355 kW	450 kW	-	560 kW	670 kW	-	-	
	<b>500 V</b>	250 kW	315 kW	400 kW	520 kW	-	560 kW	700 kW	-	-	
	<b>690 V</b>	315 kW	355 kW	500 kW	600 kW	-	750 kW	900 kW	-	-	
	<b>1000 V</b>	220 kW	280 kW	355 kW	400 kW	-	-	-	-	-	
	<b>Rated making capacity AC-3</b>	10 x Ie AC-3 acc. to IEC 60947-4-1									
	<b>Rated breaking capacity AC-3</b>	8 x Ie AC-3 acc. to IEC 60947-4-1									
<b>Short-circuit protection device for contactors</b>		without thermal overload relay									
	Motor protection excluded (2)										
	Ue $\leq 500\text{ V AC}$ - gG type fuse	630 A	800 A	1000 A	1000 A	Please consult us for coordination with circuit-breaker					
<b>Rated short-time withstand current Icw</b>		at 40 °C ambient temperature, in free air from a cold state									
	<b>1 s</b>	4600 A	4600 A	7000 A	7000 A	8000 A	10000 A	12000 A	12000 A	12000 A	
	<b>10 s</b>	4400 A	4400 A	6400 A	6400 A	7200 A	8000 A	10000 A	10000 A	10000 A	
	<b>30 s</b>	3100 A	3100 A	4500 A	4500 A	5200 A	6000 A	7500 A	7500 A	7500 A	
	<b>1 min</b>	2500 A	2500 A	3500 A	3500 A	4000 A	4500 A	5500 A	5500 A	5500 A	
	<b>15 min</b>	840 A	840 A	1300 A	1300 A	1500 A	1600 A	2200 A	2200 A	2800 A	
<b>Maximum breaking capacity</b>		cos $\varphi = 0.45$									
	<b>at 440 V</b>	4000 A	5000 A	6000 A	7500 A	10000 A					
	<b>at 690 V</b>	3500 A	4500 A	5000 A	7000 A	-					
	(cos $\varphi = 0.35$ for Ie > 100 A)										
<b>Power dissipation per pole</b>		Ie / AC-1									
		30 W	42 W	32 W	50 W	80 W	80 W	80 W	125 W	200 W	
	Ie / AC-3	16 W	21 W	17 W	28 W	-	50 W	50 W	-	-	
<b>Max. electrical switching frequency</b>		AC-1									
		300 cycles/h			300 cycles/h			300 cycles/h		60 cycles/h	
	AC-3	300 cycles/h			300 cycles/h			-		60 cycles/h	
	AC-2, AC-4	60 cycles/h			60 cycles/h			-		-	

(1) For the corresponding kW/A or hp/A values of 1500 r.p.m, 50 Hz or 1800 r.p.m, 60 Hz, 3-phase motors, see "Motor rated operational powers and currents".

(2) For the protection of motor starters against short circuits, see "Coordination with short-circuit protection devices".

(3) Conductors with preparation.

(4) Max. connection bar width 50 mm.

(5) Max. connection bar width 100 mm.

# AF09 ... AF38 3-pole contactors

## Technical data

### Main pole - Utilization characteristics according to UL / NEMA / CSA

Contactor types	AC / DC operated	AF09	AF12	AF16	AF26	AF30	AF38	
Standards		UL 60947-1 / 60947-4-1A and CSA 60947-1 / 60947-4-1A						
Max. operational voltage		600 V						
NEMA size		00	0	-	1	-	-	
NEMA continuous amp rating	Thermal current	9 A	18 A		27 A			
NEMA maximum horse power ratings 1-phase, 60 Hz	115 V AC	1/3 hp	1 hp		2 hp			
	230 V AC	1 hp	2 hp		3 hp			
NEMA maximum horse power ratings 3-phase, 60 Hz	200 V AC	1-1/2 hp	3 hp		7-1/2 hp			
	230 V AC	1-1/2 hp	3 hp		7-1/2 hp			
	460 V AC	2 hp	5 hp		10 hp			
	575 V AC	2 hp	5 hp		10 hp			
UL / CSA general use rating	600 V AC	25 A	28 A	30 A	45 A	50 A	50 A	
	With conductor cross-sectional area	AWG 10	AWG 10	AWG 10	AWG 8	AWG 8	AWG 8	
UL / CSA maximum 1-phase motor rating	Full load current	120 V AC	13.8 A	16 A	20 A	24 A	24 A	
		240 V AC	10 A	12 A	17 A	17 A	28 A	
	Horse power rating	120 V AC	3/4 hp	1 hp	1-1/2 hp	2 hp	2 hp	
		240 V AC	1-1/2 hp	2 hp	3 hp	3 hp	5 hp	
UL / CSA maximum 3-phase motor rating	Full load current (1)	200-208 V AC	7.8 A	11 A	17.5 A	25.3 A	32.2 A	32.2 A
		220-240 V AC	6.8 A	9.6 A	15.2 A	22 A	28 A	28 A
		440-480 V AC	7.6 A	11 A	14 A	21 A	27 A	27 A
		550-600 V AC	9 A	11 A	17 A	22 A	27 A (2)	27 A (2)
	Horse power rating (1)	200-208 V AC	2 hp	3 hp	5 hp	7-1/2 hp	10 hp	10 hp
		220-240 V AC	2 hp	3 hp	5 hp	7-1/2 hp	10 hp	10 hp
		440-480 V AC	5 hp	7-1/2 hp	10 hp	15 hp	20 hp	20 hp
		550-600 V AC	7-1/2 hp	10 hp	15 hp	20 hp	25 hp (2)	25 hp (2)
<b>Short-circuit protection device for contactors</b>								
without thermal overload relay - Motor protection excluded								
High fault current		100 kA						
Fuse rating		30 A	30 A	60 A	60 A	100 A	200 A	
Fuse type, 600 V		J						
<b>Max. electrical switching frequency</b>								
For general use		600 cycles/h						
For motor use		1200 cycles/h						

(1) For the corresponding kW/A or hp/A values of 1500 r.p.m, 50 Hz or 1800 r.p.m, 60 Hz, 3-phase motors, see "Motor rated operational powers and currents".

(2) For contactors produced since week 49-2011.

### General technical data

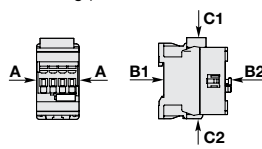
Contactor types	AC / DC operated	AF09	AF12	AF16	AF26	AF30	AF38
<b>Rated insulation voltage Ui</b>							
acc. to IEC 60947-4-1		690 V					
acc. to UL / CSA		600 V					
<b>Rated impulse withstand voltage Uimp.</b>		6 kV					
<b>Electromagnetic compatibility</b>		Devices complying with IEC 60947-1 / EN 60947-1 - Environment A					
<b>Ambient air temperature close to contactor</b>							
Operation	Fitted with thermal overload relay	-25...+60 °C					
	Without thermal overload relay	-40...+70 °C					
Storage		-60...+80 °C					
<b>Climatic withstand</b>		Category B according to IEC 60947-1 Annex Q					
<b>Maximum operating altitude (without derating)</b>		3000 m					
<b>Mechanical durability</b>							
Number of operating cycles		10 millions operating cycles					
Max. switching frequency		3600 cycles/h					
<b>Shock withstand</b>							
acc. to IEC 60068-2-27 and EN 60068-2-27							
Mounting position 1							
		<b>Shock direction</b>					
		1/2 sinusoidal shock for 11 ms: no change in contact position, closed or open position					
		<b>A</b>		30 g			
		<b>B1</b>		25 g closed position / 5 g open position			
		<b>B2</b>		15 g			
		<b>C1</b>		25 g			
<b>C2</b>		25 g					
<b>Vibration withstand</b>							
acc. to IEC 60068-2-6							
		5...300 Hz					
		4 g closed position / 2 g open position					

# AF40 ... AF96 3-pole contactors

## Technical data

### Main pole - Utilization characteristics according to UL / NEMA / CSA

Contactor types	AC / DC operated	AF40	AF52	AF65	AF80	AF96
Standards		UL 60947-1 / 60947-4-1A and CSA 60947-1 / 60947-4-1A				
Maximum operational voltage		600 V				
NEMA size		2	-	-	3	-
NEMA continuous amp rating	Thermal current	45 A	-	-	90 A	-
NEMA maximum horse power ratings						
1-phase, 60 Hz	115 V AC	3 hp	-	-	-	-
	230 V AC	7.5 hp	-	-	-	-
NEMA maximum horse power ratings						
3-phase, 60 Hz	200 V AC	10 hp	-	-	25 hp	-
	230 V AC	15 hp	-	-	30 hp	-
	460 V AC	25 hp	-	-	50 hp	-
	575 V AC	25 hp	-	-	50 hp	-
UL / CSA general use rating						
600 V AC		60 A	80 A	90 A	105 A	115 A
With conductor cross-sectional area		AWG 6	AWG 4	AWG 3	AWG 2	AWG 2
UL / CSA maximum 1-phase motor rating						
Full load current	120 V AC	34 A	34 A	56 A	80 A	80 A
	240 V AC	40 A	50 A	68 A	68 A	88 A
Horse power rating	120 V AC	3 hp	3 hp	5 hp	7-1/2 hp	7-1/2 hp
	240 V AC	7-1/2 hp	10 hp	15 hp	15 hp	20 hp
UL / CSA maximum 3-phase motor rating						
Full load current (1)	200-208 V AC	32.2 A	48.3 A	62.1 A	78.2 A	92 A
	220-240 V AC	42 A	54 A	68 A	80 A	80 A
	440-480 V AC	40 A	52 A	65 A	77 A	77 A
	550-600 V AC	41 A	52 A	62 A	77 A	77 A
Horse power rating (1)	200-208 V AC	10 hp	15 hp	20 hp	25 hp	30 hp
	220-240 V AC	15 hp	20 hp	25 hp	30 hp	30 hp
	440-480 V AC	30 hp	40 hp	50 hp	60 hp	60 hp
	550-600 V AC	40 hp	50 hp	60 hp	75 hp	75 hp
Short-circuit protection device for contactors						
without thermal overload relay - Motor protection excluded						
High fault current		100 kA				
Fuse rating		150 A	150 A	150 A	200 A	200 A
Fuse type, 600 V		J				
Maximum electrical switching frequency						
For general use		600 cycles/h				
For motor use		1200 cycles/h				

(1) For the corresponding kW/A or hp/A values of 1500 r.p.m, 50 Hz or 1800 r.p.m, 60 Hz, 3-phase motors, see "Motor rated operational powers and currents".

### General technical data

Contactor types	AC / DC operated	AF40	AF52	AF65	AF80	AF96
Rated insulation voltage Ui		690 V				
acc. to IEC 60947-4-1		600 V				
acc. to UL / CSA		1000 V				
Rated impulse withstand voltage Uimp.		6 kV				
Electromagnetic compatibility		8 kV				
Ambient air temperature close to contactor		Devices complying with IEC 60947-1 / EN 60947-1				
Operation	Fitted with thermal overload relay	(2)				
	Without thermal overload relay	-40...+70 °C				
Storage		-60...+80 °C				
Climatic withstand		Category B according to IEC 60947-1 Annex Q				
Maximum operating altitude (without derating)		3000 m				
Mechanical durability						
Number of operating cycles		10 millions operating cycles				
Maximum switching frequency		3600 cycles/h				
Shock withstand						
acc. to IEC 60068-2-27 and EN 60068-2-27						
Mounting position 1						
	Shock direction	1/2 sinusoidal shock for 11 ms: no change in contact position, closed or open position				

(2) On request.



# AF116 ... AF370 3-pole contactors

## Technical data

### Main pole - Utilization characteristics according to UL / NEMA / CSA

Contactor types	AC / DC operated	AF116	AF140	AF146	AF190	AF205	AF265	AF305	AF370
<b>Standards</b>		UL 60947-1 / 60947-4-1A and CSA 60947-1 / 60947-4-1A							
<b>Maximum operational voltage</b>		600V							
<b>NEMA size</b>		—	4	—	—	—	5	—	—
<b>NEMA continuous amp rating</b>	<b>Thermal current</b>	—	135 A	—	—	—	270 A	—	—
<b>NEMA maximum horse power ratings</b>									
<b>1-phase, 60 Hz</b>									
	115 V AC	—	—	—	—	—	—	—	—
	230 V AC	—	—	—	—	—	—	—	—
<b>NEMA maximum horse power ratings</b>									
<b>3-phase, 60 Hz</b>									
	200 V AC	—	40 hp	—	—	—	75 hp	—	—
	230 V AC	—	50hp	—	—	—	100 hp	—	—
	460 V AC	—	100 hp	—	—	—	200 hp	—	—
	575 V AC	—	100 hp	—	—	—	200 hp	—	—
<b>UL / CSA general use rating</b>									
600 V AC		160 A	200 A	200 A	230 A	250 A	300 A	350 A	400 A
600 V AC (w/ LX.. terminal extensions)		160 A	200 A	200 A	250 A	300 A	350 A	400 A	520 A
With conductor cross-sectional area		AWG 2/0	AWG 3/0	AWG 3/0	MCM 250	MCM 350 (2)	MCM 500	2//AWG 3/0	2//MCM 300
<b>UL / CSA maximum 1-phase motor rating</b>									
<b>Full load current</b>									
	120 V AC	—	—	—	—	—	—	—	—
	240 V AC	—	—	—	—	—	—	—	—
<b>Horse power rating</b>									
	120 V AC	—	—	—	—	—	—	—	—
	240 V AC	—	—	—	—	—	—	—	—
<b>UL / CSA maximum 3-phase motor rating</b>									
<b>Full load current (1)</b>									
	200-208 V AC	92 A	120 A	120 A	150 A	177 A	221 A	285 A	359 A
	220-240 V AC	104 A	130 A	130 A	154 A	192 A	248 A	312 A	360 A
	440-480 V AC	96 A	124 A	124 A	156 A	180 A	240 A	302 A	361 A
	550-600 V AC	99 A	125 A	125 A	144 A	192 A	242 A	289 A	336 A
<b>Horse power rating (1)</b>									
	200-208 V AC	30 hp	40 hp	40 hp	50 hp	60 hp	75 hp	100 hp	125 hp
	220-240 V AC	40 hp	50 hp	50 hp	60 hp	75 hp	100 hp	125 hp	150 hp
	440-480 V AC	75 hp	100 hp	100 hp	125 hp	150 hp	200 hp	250 hp	300 hp
	550-600 V AC	100 hp	125 hp	125 hp	150 hp	200 hp	250 hp	300 hp	350 hp
<b>Short-circuit protection device for contactors</b>									
without thermal overload relay - Motor protection excluded									
<b>High fault current</b>		100 kA							
<b>Fuse rating</b>		225 A	250 A	250 A	450 A	400 A	500 A	600 A	800 A
<b>Fuse type, 600 V</b>		J							
<b>Maximum electrical switching frequency</b>									
<b>For general use</b>		300 cycles/h							
<b>For motor use</b>		300 cycles/h							

(1) For the corresponding kW/A or hp/A values of 1500 r.p.m, 50 Hz or 1800 r.p.m, 60 Hz, 3-phase motors, see "Motor rated operational powers and currents".

(2) For conductor cross-sectional area above MCM 300 use terminal enlargements LW205.

### General technical data

Contactor types	AC / DC operated	AF116	AF140	AF146	AF190	AF205	AF265	AF305	AF370
<b>Rated insulation voltage Ui</b>		1000 V							
acc. to IEC 60947-4-1		600 V							
acc. to UL / CSA		600 V							
<b>Rated impulse withstand voltage Uimp.</b>		8 kV							
<b>Electromagnetic compatibility</b>		AF contactors comply with IEC 60947-1 / EN 60947-1 - Environment A							
<b>Ambient air temperature close to contactor</b>									
<b>Operation</b>									
Fitted with thermal overload relay		-25 to +55 °C							
Without thermal overload relay		-40 to +70 °C							
<b>Storage</b>		-40 to +70 °C							
<b>Maximum operating altitude (without derating)</b>		3000 m							
<b>Mechanical durability</b>									
<b>Number of operating cycles</b>		5 million operating cycles							
<b>Maximum switching frequency</b>		300 cycles/h							

# AF400 ... AF2650 3-pole contactors

## Technical data

### Main pole - Utilization characteristics according to UL / NEMA / CSA

Contactor types	AC / DC operated	AF400	AF460	AF580	AF750	AF1250	AF1350	AF1650	AF2050	AF2650
Standards		UL 60947-1 / 60947-4-1A and CSA 60947-1 / 60947-4-1A								
Maximum operational voltage		600 V								
NEMA size		-	6	-	7	-	-	8	-	-
NEMA maximum horse power ratings										
1-phase, 60 Hz	115 V AC	-	-	-	-	-	-	-	-	-
	230 V AC	-	-	-	-	-	-	-	-	-
NEMA maximum horse power ratings										
3-phase, 60 Hz	200 V AC	-	150 hp	-	-	-	-	-	-	-
	230 V AC	-	200 hp	-	300 hp	-	-	450 hp	-	-
	460 V AC	-	400 hp	-	600 hp	-	-	900 hp	-	-
	575 V AC	-	400 hp	-	600 hp	-	-	900 hp	-	-
UL / CSA general use rating										
600 V AC		550 A	650 A	750 A	900 A	1210 A	1350 A	1650 A	2100 A	2700 A
UL / CSA maximum 1-phase motor rating										
Full load current	120 V AC	-	-	-	-	-	-	-	-	-
	240 V AC	-	-	-	-	-	-	-	-	-
Horse power rating	120 V AC	-	-	-	-	-	-	-	-	-
	240 V AC	-	-	-	-	-	-	-	-	-
UL / CSA maximum 3-phase motor rating										
Full load current (1)	200-208 V AC	358.8 A	414 A	552 A	692.3 A	-	954 A	1030 A	-	-
	220-240 V AC	360 A	480 A	604 A	722 A	-	954 A	1030 A	-	-
	440-480 V AC	414 A	477 A	590 A	722 A	-	954 A	1030 A	-	-
	550-600 V AC	382 A	472 A	578 A	672 A	-	944 A	1050 A	-	-
Horse power rating (1)	200-208 V AC	125 hp	150 hp	200 hp	250 hp	-	-	-	-	-
	220-240 V AC	150 hp	200 hp	250 hp	300 hp	-	400 hp	450 hp	-	-
	440-480 V AC	350 hp	400 hp	500 hp	600 hp	-	800 hp	900 hp	-	-
	550-600 V AC	400 hp	500 hp	600 hp	700 hp	-	1000 hp	1150 hp	-	-
Short-circuit protection device for contactors										
without thermal overload relay - Motor protection excluded										
Fuse rating		1000 A		1200 A		Please consult us for coordination with circuit-breaker				
Fuse type, 600 V		L								
Maximum electrical switching frequency										
For general use		300 cycles/h				60 cycles/h			15 cycles/h	
For motor use		300 cycles/h				60 cycles/h			-	

(1) For the corresponding kW/A or hp/A values of 1500 r.p.m, 50 Hz or 1800 r.p.m, 60 Hz, 3-phase motors, see "Motor rated operational powers and currents".

### General technical data

Contactor types	AC / DC operated	AF400	AF460	AF580	AF750	AF1250	AF1350	AF1650	AF2050	AF2650
Rated insulation voltage Ui										
acc. to IEC 60947-4-1		1000 V								
acc. to UL		600 V								
Rated impulse withstand voltage Uimp.		8 kV								
Electromagnetic compatibility		AF contactors complying with IEC 60947-1 / EN 60947-1 - Environment A								
Ambient air temperature close to contactor										
Operation	Fitted with electronic overload relay	-25 to +70 °C								
	Without electronic overload relay	-40 to +70 °C								
Storage		-40 to +70 °C								
Maximum operating altitude (without derating)		3000 m								
Mechanical durability										
Number of operating cycles		3 millions operating cycles				0.5 million operating cycles			0.3 million operating cycles	
Max. switching frequency		300 cycles/h				60 cycles/h				
Shock withstand										
acc. to IEC 60068-2-27 and EN 60068-2-27										
Mounting position 1										
Shock direction		1/2 sinusoidal shock for 30 ms: no change in contact position, closed or open position								
A		5 g								
B1		5 g								
B2		5 g								
C1		5 g								
C2		5 g								

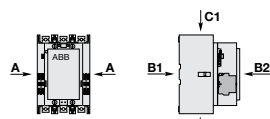

# AF09 ... AF38 3-pole contactors

## Technical data

### Magnet system characteristics

Contactor types	AC / DC operated	AF09	AF12	AF16	AF26	AF30	AF38
Coil operating limits acc. to IEC 60947-4-1	AC supply	At $\theta \leq 60\text{ }^\circ\text{C}$ $0.85 \times U_c \text{ min} \dots 1.1 \times U_c \text{ max.}$ At $\theta \leq 70\text{ }^\circ\text{C}$ $0.85 \times U_c \text{ min} \dots U_c \text{ max.}$					
	DC supply	At $\theta \leq 60\text{ }^\circ\text{C}$ $0.85 \times U_c \text{ min} \dots 1.1 \times U_c \text{ max.}$ At $\theta \leq 70\text{ }^\circ\text{C}$ (AF) $0.85 \times U_c \text{ min} \dots U_c \text{ max.}$ - (AF..Z) $0.85 \times U_c \text{ min} \dots 1.1 \times U_c \text{ max.}$					
AC control voltage 50/60 Hz		24...500 V AC					
Rated control circuit voltage $U_c$		24...500 V AC					
Coil consumption	Average pull-in value	(AF) 50 VA - (AF..Z) 16 VA					
	Average holding value	(AF) 2.2 VA / 2 W - (AF..Z) 1.7 VA / 1.5 W					
DC control voltage		12...500 V DC					
Rated control circuit voltage $U_c$		12...500 V DC					
Coil consumption	Average pull-in value	(AF) 50 W - (AF..Z) 12...16 W					
	Average holding value	(AF) 2 W - (AF..Z) 1.7 W					
PLC-output control		(AF..Z) $\geq 500\text{ mA}$ 24 V DC					
Drop-out voltage		$\leq 60\%$ of $U_c \text{ min.}$					
Voltage sag immunity acc. to SEMI F47-0706		(AF..Z) conditions of use on request					
Dips withstand $-20\text{ }^\circ\text{C} \leq \leq +60\text{ }^\circ\text{C}$		(AF..Z) 22 ms average for $U_c \geq 24\text{ V}$ 50/60 Hz or $U_c \geq 20\text{ V}$ DC					
Operating time							
Between coil energization and:	N.O. contact closing	40...95 ms					
	N.C. contact opening	38...90 ms					
Between coil de-energization and:	N.O. contact opening	11...95 ms					
	N.C. contact closing	13...98 ms					

### Mounting characteristics and conditions for use

Contactor types	AC / DC operated	AF09	AF12	AF16	AF26	AF30	AF38
Mounting positions							
Mounting distances		Max. N.C. built-in and add-on N.C. auxiliary contacts: see accessory fitting details for a 3-pole contactor AF09 ... AF38					
Fixing		The contactors can be assembled side by side					
On rail according to IEC 60715, EN 60715		35 x 7.5 mm or 35 x 15 mm					
By screws (not supplied)		2 x M4 screws placed diagonally					

# AF40 ... AF96 3-pole contactors

## Technical data

### Magnet system characteristics

Contactor types	AC / DC operated	AF40	AF52	AF65	AF80	AF96
Coil operating limits acc. to IEC 60947-4-1	AC supply	At $\theta \leq 70^\circ\text{C}$ $0.85 \times U_c \text{ min} \dots 1.1 \times U_c \text{ max.}$				
	DC supply	At $\theta \leq 70^\circ\text{C}$ $0.85 \times U_c \text{ min} \dots 1.1 \times U_c \text{ max.}$				
<b>AC control voltage 50/60 Hz</b>						
Rated control circuit voltage $U_c$		24...500 V AC				
Coil consumption	Average pull-in value	25 VA				40 VA
	Average holding value	4 VA / 2 W				
<b>DC control voltage</b>						
Rated control circuit voltage $U_c$		20...500 V DC				
Coil consumption	Average pull-in value	25 W				40 W
	Average holding value	2 W				
<b>PLC-output control</b>						
Drop-out voltage		$\leq 60\%$ of $U_c \text{ min.}$				
<b>Voltage sag immunity</b> acc. to SEMI F47-0706						
Dips withstand		conditions of use on request				
<b>Operating time</b>						
Between coil energization and:	N.O. contact closing	42...100 ms				
	N.C. contact opening	38...95 ms				
Between coil de-energization and:	N.O. contact opening	17...100 ms				
	N.C. contact closing	19...105 ms				

### Mounting characteristics and conditions for use

Contactor types	AC / DC operated	AF40	AF52	AF65	AF80	AF96
<b>Mounting positions</b>						
Max. N.C. built-in and add-on N.C. auxiliary contacts: see accessory fitting details for a 3-pole contactor AF40 ... AF96						
<b>Mounting distances</b>						
The contactors can be assembled side by side						
<b>Fixing</b>						
On rail according to IEC 60715, EN 60715		35 x 7.5 mm or 35 x 15 mm				35 x 15 mm
By screws (not supplied)		2 x M4 or 2 x M6 screws placed diagonally				

# AF116 ... AF370 3-pole contactors

## Technical data

### Magnet system characteristics

Contactor types	AC / DC operated	AF116	AF140	AF146	AF190	AF205	AF265	AF305	AF370
Coil operating limits	AC supply	At $\theta \leq 70^\circ\text{C}$ $0.85 \times U_c \text{ min} \dots 1.1 \times U_c \text{ max}$							
acc. to IEC 60947-4-1	DC supply	At $\theta \leq 70^\circ\text{C}$ $0.80 \times U_c \text{ min} \dots 1.1 \times U_c \text{ max}$							
<b>Rated control circuit voltage <math>U_c</math></b>									
<b>Coil consumption</b>									
<b>AC control voltage 50/60 Hz</b>									
24...60 V AC	Average pull-in value	225 VA			165 VA		475 VA		
	Average holding value	5.5 VA			6 VA		8.5 VA		
48...130 V AC	Average pull-in value	170 VA			175 VA		340 VA		
	Average holding value	4 VA			4 VA		17 VA		
100...250 V AC	Average pull-in value	130 VA			220 VA		385 VA		
	Average holding value	6 VA			7 VA		17.5 VA		
250...500 V AC	Average pull-in value	200 VA			200 VA		400 VA		
	Average holding value	18 VA			18 VA		20 VA		
<b>DC control voltage</b>									
20...60 V DC	Average pull-in value	210 W			205 W		400 W		
	Average holding value	2.5 W			2.5 W		3 W		
48...130 V DC	Average pull-in value	130 W			130 W		360 W		
	Average holding value	2.5 W			2.5 W		2.5 W		
100...250 V DC	Average pull-in value	135 W			190 W		410 W		
	Average holding value	3 W			2.5 W		4.5 W		
250...500 V DC	Average pull-in value	180 W			160 W		270 W		
	Average holding value	3.5 W			3.5 W		4 W		
<b>Drop-out voltage</b>		55 % of $U_c \text{ min}$							
<b>Operating time</b>									
<b>Coil supply between A1 - A2</b>									
Between coil energization and:	N.O. contact closing	20...55 ms			25...60 ms		30...60 ms		
Between coil de-energization and:	N.O. contact opening	40...70 ms			45...80 ms		45...80 ms		

### Mounting characteristics and conditions for use

Contactor types	AC / DC operated	AF116	AF140	AF146	AF190	AF205	AF265	AF305	AF370
<b>Mounting positions</b>									
Max. add-on N.O. or N.C. auxiliary contacts: see accessory fitting details for 3-pole contactor AF116 ... AF370									
<b>Mounting distances</b>									
The contactors can be assembled side by side									
<b>Fixing</b>									
On rail acc. to IEC 60715, EN 60715									
By screws (not supplied)									
4 x M5									

# AF400 ... AF2650 3-pole contactors

## Technical data

### Magnet system characteristics

Contactor types	AC / DC operated	AF400	AF460	AF580	AF750	AF1250	AF1350	AF1650	AF2050	AF2650
Coil operating limits	AC supply	At $\theta \leq 70^\circ\text{C}$ $0.85 \times U_c \text{ min} \dots 1.1 \times U_c \text{ max}$								
acc. to IEC 60947-4-1	DC supply	At $\theta \leq 70^\circ\text{C}$ $0.80 \times U_c \text{ min} \dots 1.1 \times U_c \text{ max}$								
Rated control circuit voltage $U_c$										
Coil consumption										
AC control voltage 50/60 Hz										
24...60 V AC	Average pull-in value	900 VA		780 VA		-				
	Average holding value	12 VA		12 VA		-				
48...130 V AC	Average pull-in value	1215 VA		1100 VA		-				
	Average holding value	12 VA		12 VA		-				
100...250 V AC	Average pull-in value	955 VA		880 VA		2450 VA		-		
	Average holding value	12 VA		12 VA		48 VA		-		
250 ... 500 V AC	Average pull-in value	950 VA		985 VA		-				
	Average holding value	12 VA		12 VA		-				
DC control voltage										
20...60 V DC	Average pull-in value	900 VA		785 VA		-				
	Average holding value	5 VA		5.5 VA		-				
48...130 V DC	Average pull-in value	1150 VA		1020 VA		-				
	Average holding value	5 VA		5 VA		-				
100...250 V DC	Average pull-in value	895 VA		880 VA		2290 VA		-		
	Average holding value	5 VA		5 VA		20.5 VA		-		
250 ... 500 V AC	Average pull-in value	885 VA		910 VA		-				
	Average holding value	7.5 VA		7.5 VA		-				
Drop-out voltage	55 % of $U_c \text{ min.}$									
Voltage sag immunity	Conditions of use on request									
acc. to SEMI F47										
Dips withstand	$\geq 20 \text{ ms}$									
Operating time										
Coil supply between A1 - A2										
Between coil energization and:	Main contact closing	50...120 ms				50...80 ms				
Between coil de-energization and:	Main contact opening	33...70 ms				35...55 ms				
Control input for PLC's										
Between coil energization and:	Main contact closing	40...60 ms		40...90 ms		40...65 ms				
Between coil de-energization and:	Main contact opening	10...30 ms				10...30 ms				















### Mounting characteristics and conditions for use

Contactor types	AC / DC operated	AF400	AF460	AF580	AF750	AF1250	AF1350	AF1650	AF2050	AF2650
Mounting positions										
Max. add-on N.O. or N.C. auxiliary contacts: see accessory fitting details for 3-pole contactor AF400 ... AF2650										
Mounting distances										
The contactors can be assembled side by side										
Fixing										
On rail according to IEC 60715, EN 60715										
By screws (not supplied)										
		4 x M5		4 x M6		4 x M8				

# AF09 ... AF38 3-pole contactors

## Technical data











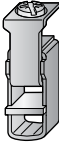
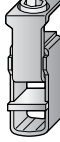



### Connecting characteristics

Contactor types	AC / DC operated	AF09	AF12	AF16	AF26	AF30	AF38
<b>Main terminals</b>		 Screw terminals with cable clamp					
<b>Connection capacity (min. ... max.)</b>							
<b>Main conductors (poles)</b>							
	Rigid	Solid ( $\leq 4 \text{ mm}^2$ )	} 1 x	1...6 mm <sup>2</sup>		2.5...10 mm <sup>2</sup>	
		Stranded ( $\geq 6 \text{ mm}^2$ )		2 x	1...6 mm <sup>2</sup>		2.5...10 mm <sup>2</sup>
	Flexible with non insulated ferrule		1 x	0.75...6 mm <sup>2</sup>		1.5...10 mm <sup>2</sup>	
			2 x	0.75...6 mm <sup>2</sup>		1.5...10 mm <sup>2</sup>	
	Flexible with insulated ferrule		1 x	0.75...4 mm <sup>2</sup>		1.5...10 mm <sup>2</sup>	
			2 x	0.75...2.5 mm <sup>2</sup>		1.5...4 mm <sup>2</sup>	
	Bars or lugs		L <	9.6 mm		12.5 mm	
Connection capacity acc. to UL/CSA			1 or 2 x	AWG 16...10		AWG 14...8	
Stripping length				10 mm		14 mm	
Tightening torque				1.5 Nm / 13 lb.in		2.5 Nm / 22 lb.in	
<b>Auxiliary conductors</b>							
(built-in auxiliary terminals + coil terminals)							
	Rigid solid		1 x	1...2.5 mm <sup>2</sup>			
			2 x	1...2.5 mm <sup>2</sup>			
	Flexible with non insulated ferrule		1 x	0.75...2.5 mm <sup>2</sup>			
			2 x	0.75...2.5 mm <sup>2</sup>			
	Flexible with insulated ferrule		1 x	0.75...2.5 mm <sup>2</sup>			
			2 x	0.75...1.5 mm <sup>2</sup>			
	Lugs		L <	8 mm			
Connection capacity acc. to UL/CSA			1 or 2 x	AWG 18...14			
Stripping length				10 mm			
Tightening torque							
Coil terminals				1.2 Nm / 11 lb.in			
Built-in auxiliary terminals				1.2 Nm / 11 lb.in			
<b>Degree of protection</b>							
acc. to IEC 60947-1 / EN 60947-1 and IEC 60529 / EN 60529							
Main terminals		IP20					
Coil terminals		IP20					
Built-in auxiliary terminals		IP20					
<b>Screw terminals</b>		Delivered in open position, screws of unused terminals must be tightened					
Main terminals		M3.5			M4		
		<b>Screwdriver type</b>		Flat Ø 5.5 / Pozidriv 2		Flat Ø 6.5 / Pozidriv 2	
Coil terminals		M3.5					
		<b>Screwdriver type</b>		Flat Ø 5.5 / Pozidriv 2			
Built-in auxiliary terminals		M3.5					
		<b>Screwdriver type</b>		Flat Ø 5.5 / Pozidriv 2			

# AF40 ... AF96 3-pole contactors

## Technical data

### Connecting characteristics

Contactor types	AC / DC operated	AF40	AF52	AF65	AF80	AF96
<b>Main terminals</b>						
		Screw terminals with double connector 2 x (9.3 width x 7.9/10.3 depth)			Screw terminals with double connector 2 x (12.4 width x 9.3/11.1 depth)	
<b>Connection capacity (min. ... max.)</b>						
<b>Main conductors (poles)</b>						
 Rigid	Solid ( $\leq 4 \text{ mm}^2$ )	} <b>1 x</b>	6...35 mm <sup>2</sup>			6...70 mm <sup>2</sup>
 Stranded ( $\geq 6 \text{ mm}^2$ )			<b>2 x</b> 6...35 mm <sup>2</sup>			6...50 mm <sup>2</sup>
 Flexible with non insulated ferrule		<b>1 x</b>	4...35 mm <sup>2</sup>			6...50 mm <sup>2</sup>
 Flexible with insulated ferrule		<b>2 x</b>	4...35 mm <sup>2</sup>			6...50 mm <sup>2</sup>
 Flexible with insulated ferrule		<b>1 x</b>	4...35 mm <sup>2</sup>			6...50 mm <sup>2</sup>
 Flexible with insulated ferrule		<b>2 x</b>	4...35 mm <sup>2</sup>			6...50 mm <sup>2</sup>
 Bars or lugs		<b>L &lt;</b>	9.2 mm			12.2 mm
Connection capacity acc. to UL/CSA		<b>1 or 2 x</b>	AWG 10...2			AWG 6...1
Stripping length			16 mm			17 mm
Tightening torque			4 Nm / 35 lb.in			6 Nm / 53 lb.in
<b>Auxiliary conductors</b> (built-in auxiliary terminals + coil terminals)						
 Rigid solid		<b>1 x</b>	1...2.5 mm <sup>2</sup>			
 Rigid solid		<b>2 x</b>	1...2.5 mm <sup>2</sup>			
 Flexible with non insulated ferrule		<b>1 x</b>	0.75...2.5 mm <sup>2</sup>			
 Flexible with non insulated ferrule		<b>2 x</b>	0.75...2.5 mm <sup>2</sup>			
 Flexible with insulated ferrule		<b>1 x</b>	0.75...2.5 mm <sup>2</sup>			
 Flexible with insulated ferrule		<b>2 x</b>	0.75...2.5 mm <sup>2</sup>			
 Lugs		<b>L &lt;</b>	8 mm			
Connection capacity acc. to UL/CSA		<b>1 or 2 x</b>	AWG 18...14			
Stripping length			10 mm			
Tightening torque			1.2 Nm / 11 lb.in			
Coil terminals			1.2 Nm / 11 lb.in			
Built-in auxiliary terminals			1.2 Nm / 11 lb.in			
<b>Degree of protection</b> acc. to IEC 60947-1 / EN 60947-1 and IEC 60529 / EN 60529						
Main terminals			IP10			
Coil terminals			IP20			
Built-in auxiliary terminals			IP20			
<b>Screw terminals</b>						
Main terminals			Delivered in open position, screws of unused terminals must be tightened			
		<b>Screwdriver type</b>	M6			M8
Coil terminals		<b>Screwdriver type</b>	Flat Ø 6.5 / Pozidriv 2			Hexagon socket (s = 4 mm)
		<b>Screwdriver type</b>	M3.5			
Built-in auxiliary terminals		<b>Screwdriver type</b>	Flat Ø 5.5 / Pozidriv 2			
		<b>Screwdriver type</b>	M3.5			
		<b>Screwdriver type</b>	Flat Ø 5.5 / Pozidriv 2			



# AF116 ... AF370 3-pole contactors

## Technical data

### Connecting characteristics

Contactor types	AC / DC operated	AF116	AF140	AF146	AF190	AF205	AF265	AF305	AF370
<b>Main terminals</b>									
Flat type									
<b>Connection capacity (min. ... max.)</b>									
<b>Main conductors (poles)</b>									
	Cu cable - Stranded	1 x	10...95 mm <sup>2</sup>		6...150 mm <sup>2</sup>		16...300 mm <sup>2</sup>		
	Clamp type		LD... included (1)		1SDA066917R1		1SDA055016R1		
	Tightening torque		8 Nm		14 Nm		25 Nm		
	Cu cable - Stranded	2 x	10...95 mm <sup>2</sup>		50...120 mm <sup>2</sup>		70...185 mm <sup>2</sup>		
	Clamp type		LD... included (1)		1SFN074709R1000, LZ185-2C/120		1SCA022194R0890, OZXB4		
	Tightening torque		8 Nm		16 Nm		22 Nm		
	Al cable - Stranded	1 x	-		95...185 mm <sup>2</sup>		185...240 mm <sup>2</sup>		
	Clamp type		-		1SDA054988R1		1SDA055020R1		
	Tightening torque		-		31 Nm		43 Nm		
	Cu cable - Flexible	1 x	10...70 mm <sup>2</sup>		6...120 mm <sup>2</sup>		16...240 mm <sup>2</sup>		
	Clamp type		LD... included (1)		1SDA066917R1		1SDA055016R1		
	Tightening torque		8 Nm		14 Nm		25 Nm		
	Cu cable - Flexible	2 x	10...70 mm <sup>2</sup>		50...95 mm <sup>2</sup>		70...185 mm <sup>2</sup>		
	Clamp type		LD... included (1)		1SFN074709R1000, LZ185-2C/120		1SCA022194R0890, OZXB4		
	Tightening torque		8 Nm		16 Nm		22 Nm		
	Lugs	W ≤	22 mm (.866 in)		24 mm (.945 in)		32 mm (1.260 in)		
		Ø >	6 mm (.236 in)		8 mm (.315 in)		10 mm (.394 in)		
	Socket type		LL... included		LL... included		LL... included		
	Tightening torque		9 Nm / 80 lb.in		18 Nm / 160 lb.in		28 Nm / 248 lb.in		
Connection capacity acc. to UL / CSA		1 x	AWG 6...3/0		6...300 MCM		4...400 MCM		
	Clamp type		LD... included (1)		ATK185 (2)		ATK300 (2)		
	Tightening torque		8 Nm / 71 lb.in		34 Nm / 301 lb.in		42 Nm / 372 lb.in		
Connection capacity acc. to UL / CSA		2 x	AWG 6...3/0		-		4...500 MCM		
	Clamp type		LD... included (1)		-		ATK300/2 (2)		
	Tightening torque		8 Nm / 71 lb.in		-		42 Nm / 372 lb.in		
<b>Auxiliary conductors</b>									
(coil terminals)									
	Solid / stranded	1 x	1...4 mm <sup>2</sup>						
		2 x	1...4 mm <sup>2</sup>						
	Flexible	1 x	0.75...2.5 mm <sup>2</sup>						
		2 x	0.75...2.5 mm <sup>2</sup>						
	Flexible with non insulated ferrule	1 x	0.75...2.5 mm <sup>2</sup>						
		2 x	0.75...2.5 mm <sup>2</sup>						
	Flexible with insulated ferrule	1 x	0.75...2.5 mm <sup>2</sup>						
		2 x	0.75...2.5 mm <sup>2</sup>						
	Lugs	L <	8 mm						
		L >	3.5 mm						
Connection capacity acc. to UL / CSA		1 or 2 x	AWG 18...14						
Stripping length			9 mm						
Tightening torque			1.00 Nm / 9 lb.in						
<b>Degree of protection</b>									
acc. to IEC 60947-1 / EN 60947-1 and IEC 60529 / EN 60529									
Main terminals			IP00						
Coil terminals			IP20						
<b>Screw terminals</b>									
Main terminals			M6		M8		M10		
		Screwdriver type	Screws and bolts						
Coil terminals (delivered in open position)			M3.5						
		Screwdriver type	Flat Ø 5.5 mm / Pozidriv 2						











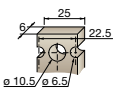
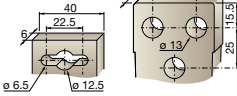
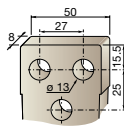
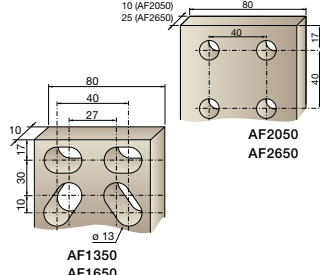

(1) LD... not included for AF116 ... AF146-30...B.

(2) Available in North America only.

# AF400 ... AF2650 3-pole contactors

## Technical data

### Connecting characteristics

Contactor types	AC / DC operated	AF400	AF460	AF580	AF750	AF1250	AF1350	AF1650	AF2050	AF2650
<b>Main terminals</b>										
Flat type										
										
<b>Connection capacity (min. ... max.)</b>										
<b>Main conductors (poles)</b>										
	Cu cable - Stranded	2 x	240 mm <sup>2</sup>		-		-			
	Clamp type		1SDA013922R1		-		-			
	Tightening torque		35 Nm		-		-			
	Cu cable - Stranded	3 x	-	185 mm <sup>2</sup>		-		-		-
	Clamp type		-	1SDA013956R1		-		-		-
	Tightening torque		-	35 Nm		45 Nm		-		-
	Al cable - Stranded	2 x	240 mm <sup>2</sup>		-		-			
	Clamp type		1SDA013922R1		-		-			
	Tightening torque		35 Nm		-		-			
		3 x	-	185 mm <sup>2</sup>		-		-		-
	Clamp type		-	1SDA013956R1		-		-		-
	Tightening torque		-	35 Nm		45 Nm		-		-
	Lugs	W ≤	47 mm		50 mm		100 mm		-	
		Ø >	10 mm		12 mm		-		-	
	Tightening torque		35 Nm / 310 lb.in		45 Nm / 398 lb.in		-		-	
Connection capacity acc. to UL / CSA										
		2 x	250-500 MCM alt. 2/0 AWG-400 MCM		-		2// 3 x 0.25 in bars, use LW1250		4/0 AWG - 500 MCM 4//4 x 0.25 in	
	Clamp type		K6TH alt. ATK580		-		K7TK ATK1350/4		K7TK bars	
	Tightening torque		275 lb.in		-		375 lb.in		-	
Connection capacity acc. to UL / CSA										
		3 x	2/0 AWG-400 MCM		2/0 AWG-500 MCM		1/0-750 MCM		-	
	Clamp type		K6TJ		ATK750/3		K8TL, K8TM, ATK1650/4		K8TL, K8TM, ATK1650/4, ATK1650/6	
	Tightening torque		275 lb.in		375 lb.in		500 lb.in		-	
<b>Auxiliary conductors (coil terminals)</b>										
	Solid / stranded	1 x	1...4 mm <sup>2</sup>		-		-			
		2 x	1...4 mm <sup>2</sup>		-		-			
	Flexible	1 x	0.75...2.5 mm <sup>2</sup>		-		-			
		2 x	0.75...2.5 mm <sup>2</sup>		-		-			
	Flexible with non insulated ferrule	1 x	0.75...2.5 mm <sup>2</sup>		-		-			
		2 x	0.75...2.5 mm <sup>2</sup>		-		-			
	Flexible with insulated ferrule	1 x	0.75...2.5 mm <sup>2</sup>		-		-			
		2 x	0.75...2.5 mm <sup>2</sup>		-		-			
	Lugs	L ≤	8 mm		-		-			
		L >	3.7 mm		-		-			
Connection capacity acc. to UL / CSA										
		1 or 2 x	AWG 18...14		-		-			
	Tightening torque	Recommended	1.00 Nm / 9 lb.in		-		-			
		Max.	1.20 Nm		-		-			
<b>Degree of protection</b>										
acc. to IEC 60947-1 / EN 60947-1 and IEC 60529 / EN 60529										
Main terminals										
IP00										
Coil terminals										
IP20										
<b>Screw terminals</b>										
Main terminals										
M10 M12										
Screws and bolts										
Coil terminals (delivered in open position)										
M3.5										
Screwdriver type										
Flat Ø 5.5 mm / Pozidriv 2										

2

# AF09 ... AF96 3-pole contactors

## Technical data

### Built-in auxiliary contacts according to IEC

Contactor types	AC / DC operated	AF09	AF12	AF16	AF26	AF30	AF38	AF40	AF52	AF65	AF80	AF96
Rated operational voltage U <sub>e</sub> max.		690 V										
Rated frequency (without derating)		50 / 60 Hz										
Conventional free air thermal current I <sub>th</sub> - θ ≤ 40 °C		16 A										
le / Rated operational current AC-15 acc. to IEC 60947-5-1	24-127 V 50/60 Hz	6 A										
	220-240 V 50/60 Hz	4 A										
	400-440 V 50/60 Hz	3 A										
	500 V 50/60 Hz	2 A										
	690 V 50/60 Hz	2 A										
Making capacity AC-15		10 x I <sub>e</sub> AC-15 acc. to IEC 60947-5-1										
Breaking capacity AC-15		10 x I <sub>e</sub> AC-15 acc. to IEC 60947-5-1										
le / Rated operational current DC-13 acc. to IEC 60947-5-1	24 V DC	6 A / 144 W										
	48 V DC	2.8 A / 134 W										
	72 V DC	1 A / 72 W										
	110 V DC	0.55 A / 60 W										
	125 V DC	0.55 A / 69 W										
	220 V DC	0.27 A / 60 W										
	250 V DC	0.27 A / 68 W										
	400 V DC	0.15 A / 60 W										
	500 V DC	0.13 A / 65 W										
	600 V DC	0.1 A / 60 W										
Short-circuit protection device gG type fuse		10 A										
Rated short-time withstand current I <sub>ow</sub>	for 1.0 s	100 A										
	for 0.1 s	140 A										
Minimum switching capacity with failure rate acc. to IEC 60947-5-4		12 V / 3 mA										
Non-overlapping time between N.O. and N.C. contacts		10 <sup>-7</sup>										
Power dissipation per pole at 6 A		≥ 2 ms										
Max. electrical switching frequency	AC-15	0.1 W										
	DC-13	1200 cycles/h										
		900 cycles/h										
Mechanically linked contacts acc. to annex L of IEC 60947-5-1		Built-in N.O. or N.C. auxiliary contacts and additional N.O. or N.C. auxiliary contacts (CA4, CAL4, CAT4 aux. contact blocks) are mechanically linked contacts.										
Mirror contacts acc. to annex F of IEC 60947-4-1		Built-in N.C. auxiliary contacts or additional N.C. auxiliary contacts (CA4, CAL4, CAT4 aux. contact blocks) are mirror contacts.										



### Built-in auxiliary contacts according to UL / CSA

Contactor types	AC / DC operated	AF09	AF12	AF16	AF26	AF30	AF38	AF40	AF52	AF65	AF80	AF96
Max. operational voltage		600 V AC, 600 V DC										
Pilot duty		A600, Q600										
AC thermal rated current		10 A										
AC maximum volt-ampere making		7200 VA										
AC maximum volt-ampere breaking		720 VA										
DC thermal rated current		2.5 A										
DC maximum volt-ampere making-breaking		69 VA										

# AF09 ... AF38 4-pole contactors

## Technical data

### Main pole - Utilization characteristics according to IEC

Contactors types	AC / DC operated	AF09	AF16	AF26	AF38
Standards		IEC 60947-1 / 60947-4-1 and EN 60947-1 / 60947-4-1			
Rated operational voltage $U_e$ max.		690 V			
Rated frequency (without derating)		50 / 60 Hz			
Conventional free-air thermal current $I_{th}$ acc. to IEC 60947-4-1, open contactors, $\theta \leq 40^\circ\text{C}$ With conductor cross-sectional area		35 A	35 A	55 A	55 A
		6 mm <sup>2</sup>	6 mm <sup>2</sup>	16 mm <sup>2</sup>	16 mm <sup>2</sup>
<b>AC-1 Utilization category</b>					
For air temperature close to contactor					
$I_e$ / Rated operational current AC-1 $U_e$ max. $\leq 690$ V, 50/60 Hz	$\theta \leq 40^\circ\text{C}$	25 A	30 A	45 A	55 A
	$\theta \leq 60^\circ\text{C}$	25 A	30 A	40 A	45 A
	$\theta \leq 70^\circ\text{C}$	22 A	26 A	32 A	37 A
With conductor cross-sectional area		4 mm <sup>2</sup>	6 mm <sup>2</sup>	10 mm <sup>2</sup>	16 mm <sup>2</sup>
<b>AC-3 Utilization category</b>					
For air temperature close to contactor $\theta \leq 60^\circ\text{C}$					
$I_e$ / Max. rated operational current AC-3 (1)					
	220-230-240 V	9 A	18 A	23.2 A	23.2 A
 3-phase motors	380-400 V	9 A	18 A	22 A	22 A
	415 V	9 A	18 A	21.2 A	21.2 A
	440 V	9 A	18 A	20 A	20 A
	500 V	9.5 A	15 A	17.6 A	17.6 A
	690 V	7 A	10.5 A	10.5 A	10.5 A
Rated operational power AC-3 (1)					
	220-230-240 V	2.2 kW	4 kW	5.5 kW	5.5 kW
 1500 r.p.m. 50 Hz 1800 r.p.m. 60 Hz 3-phase motors	380-400 V	4 kW	7.5 kW	11 kW (2)	11 kW (2)
	415 V	4 kW	9 kW	11 kW	11 kW
	440 V	4 kW	9 kW	11 kW	11 kW
	500 V	5.5 kW	9 kW	11 kW	11 kW
	690 V	5.5 kW	9 kW	9 kW	9 kW
Rated making capacity AC-3		10 x $I_e$ AC-3 acc. to IEC 60947-4-1			
Rated breaking capacity AC-3		8 x $I_e$ AC-3 acc. to IEC 60947-4-1			
<b>Short-circuit protection device for contactors</b>					
Without thermal overload relay - Motor protection excluded					
$U_e \leq 500$ V AC - gG type fuse		25 A	32 A	50 A	63 A
Rated short-time withstand current $I_{cw}$ At 40 °C ambient temperature, in free air from a cold state	1 s	300 A	300 A	450 A	450 A
	10 s	150 A	150 A	300 A	300 A
	30 s	80 A	80 A	225 A	225 A
	1 min	60 A	60 A	150 A	150 A
	15 min	35 A	35 A	55 A	55 A
Power dissipation per pole	$I_e$ / AC-1	0.8 W	1.2 W	1.6 W	2.3 W
	$I_e$ / AC-3	0.1 W	0.35 W	0.42 W	0.42 W
Max. electrical switching frequency	AC-1	600 cycles/h			
	AC-3	600 cycles/h			

(1) For the corresponding kW/A or hp/A values of 1500 r.p.m. 50 Hz or 1800 r.p.m. 60 Hz, 3-phase motors, see "Motor rated operational powers and currents".

(2) 400V 3-phase motor only.

### Main pole - Utilization characteristics according to UL / CSA

Contactors types	AC / DC operated	AF09	AF16	AF26	AF38
Standards		UL 60947-1 / 60947-4-1A and CSA 60947-1 / 60947-4-1A			
Max. operational voltage		600 V			
UL / CSA general use rating	600 V AC	25 A	30 A	45 A	55 A
	With conductor cross-sectional area	AWG 10	AWG 10	AWG 8	AWG 6
Max. electrical switching frequency		600 cycles/h			
	For general use	600 cycles/h			

Note: 4-pole contactors fitted with 2 N.O. + 2 N.C. main poles, see "General technical data".

# AF09 ... AF38 4-pole contactors

## Technical data

### Magnet system characteristics

Contactor types	AC / DC operated	AF09	AF16	AF26	AF38
Coil operating limits acc. to IEC 60947-4-1	AC supply	At $\theta \leq 60\text{ }^\circ\text{C}$ $0.85 \times U_c \text{ min} \dots 1.1 \times U_c \text{ max}$ . At $\theta \leq 70\text{ }^\circ\text{C}$ $0.85 \times U_c \text{ min} \dots U_c \text{ max}$ .			
	DC supply	At $\theta \leq 60\text{ }^\circ\text{C}$ $0.85 \times U_c \text{ min} \dots 1.1 \times U_c \text{ max}$ . At $\theta \leq 70\text{ }^\circ\text{C}$ (AF) $0.85 \times U_c \text{ min} \dots U_c \text{ max}$ . - (AF..Z) $0.85 \times U_c \text{ min} \dots 1.1 \times U_c \text{ max}$ .			
<b>AC control voltage 50/60 Hz</b>					
Rated control circuit voltage $U_c$		24...500 V AC			
Coil consumption	Average pull-in value	(AF) 50 VA - (AF..Z) 16 VA			
	Average holding value	(AF) 2.2 VA / 2 W - (AF..Z) 1.7 VA / 1.5 W			
<b>DC control voltage</b>					
Rated control circuit voltage $U_c$		12...500 V DC			
Coil consumption	Average pull-in value	(AF) 50 W - (AF..Z) 12...16 W			
	Average holding value	(AF) 2 W - (AF..Z) 1.7 W (AF..Z) $\geq 500\text{ mA}$ 24 V DC			
<b>PLC-output control</b>					
Drop-out voltage		$\leq 60\%$ of $U_c \text{ min}$ .			
<b>Voltage sag immunity</b> acc. to SEMI F47-0706					
Dips withstand		(AF..Z) conditions of use on request			
-20 °C $\leq$ $\leq$ +60 °C					
(AF..Z) 22 ms average for $U_c \geq 24\text{ V}$ 50/60 Hz or $U_c \geq 20\text{V}$ DC					
<b>Operating time</b>					
Between coil energization and:	N.O. contact closing	40...95 ms			
	N.C. contact opening	38...90 ms			
Between coil de-energization and:	N.O. contact opening	11...95 ms			
	N.C. contact closing	13...98 ms			

### Mounting characteristics and conditions for use

Contactor types	AF09	AF16	AF26	AF38
Mounting positions				
Mounting distances	Max. add-on N.C. auxiliary contacts: see accessory fitting details for a 4-pole contactor AF09 ... AF38			
Fixing	The contactors can be assembled side by side			
On rail according to IEC 60715, EN 60715	35 x 7.5 mm or 35 x 15 mm			
	By screws (not supplied)	2 x M4 screws placed diagonally		

# AF09 ... AF38 4-pole contactors

## Technical data

### General technical data

Contactor types	AC / DC operated	AF09	AF16	AF26	AF38
<b>Rated insulation voltage <math>U_i</math></b>					
acc. to IEC 60947-4-1		690 V			
acc. to UL / CSA		600 V			
<b>Rated impulse withstand voltage <math>U_{imp}</math></b>		6 kV			
<b>Electromagnetic compatibility</b>		Devices complying with IEC 60947-1 / EN 60947-1 - Environment A			
<b>Ambient air temperature close to contactor</b>					
Operation		-40...+70 °C			
Storage		-60...+80 °C			
<b>Climatic withstand</b>		Category B according to IEC 60947-1 Annex Q			
<b>Maximum operating altitude (without derating)</b>		3000 m			
<b>Mechanical durability</b>					
Number of operating cycles		10 millions operating cycles			
Max. switching frequency		3600 cycles/h			
<b>Shock withstand</b>					
acc. to IEC 60068-2-27 and EN 60068-2-27					
Mounting position 1					
	<b>Shock direction</b>	1/2 sinusoidal shock for 11 ms: no change in contact position, closed or open position			
	4 N.O. Main poles	<b>A</b>	30 g		
		<b>B1</b>	25 g closed position / 5 g open position		
		<b>B2</b>	15 g		
		<b>C1</b>	25 g		
		<b>C2</b>	25 g		
	2 N.O. + 2 N.C. Main poles	<b>A</b>	30 g closed position / 25 g open position		
		<b>B1</b>	25 g closed position / 5 g open position		
		<b>B2</b>	15 g closed position / 10 g open position		
		<b>C1</b>	25 g closed position / 20 g open position		
		<b>C2</b>	25 g closed position / 20 g open position		
<b>Vibration withstand</b>					
acc. to IEC 60068-2-6		5...300 Hz			
		4 g closed position / 2 g open position			

### Remark for 4-pole contactors fitted with 2 N.O. + 2 N.C. main poles

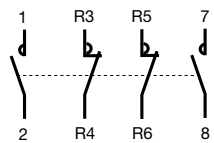

These contactors are suitable for controlling 2 separate circuits, i.e. 2 loads with 2 separate supplies, or 1 circuit comprising 2 separate loads with a single supply (see diagrams below). When the contactor operates there is no mechanical overlapping between the N.O. poles and the N.C. poles: BREAK before MAKE.



These contactors are not suitable for a reversing starter or for controlling a single load from 2 separate supplies.

### Block diagrams

– Single supply and 2 separate loads

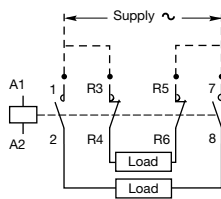



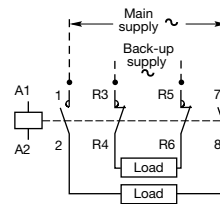







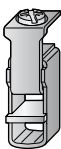



– 2 separate supplies and 2 separate loads



# AF09 ... AF38 4-pole contactors

## Technical data

### Connecting characteristics

Contactor types	AF09	AF16	AF26	AF38
<b>Main terminals</b>				
	Screw terminals with cable clamp		Screw terminals with double connector 2 x (5.5 width x 6.8 depth)	
<b>Connection capacity (min. ... max.)</b>				
<b>Main conductors (poles)</b>				
 Rigid	Solid ( $\leq 4 \text{ mm}^2$ )	} 1 x	1...6 mm <sup>2</sup>	1.5...16 mm <sup>2</sup>
 Stranded ( $\geq 6 \text{ mm}^2$ )			2 x	1...6 mm <sup>2</sup>
 Flexible with non insulated ferrule		1 x	0.75...6 mm <sup>2</sup>	1.5...16 mm <sup>2</sup>
 Flexible with non insulated ferrule		2 x	0.75...6 mm <sup>2</sup>	1.5...16 mm <sup>2</sup>
 Flexible with insulated ferrule		1 x	0.75...4 mm <sup>2</sup>	1.5...16 mm <sup>2</sup>
 Flexible with insulated ferrule		2 x	0.75...2.5 mm <sup>2</sup>	1.5...16 mm <sup>2</sup>
 Bars or lugs		L <	9.6 mm	-
Connection capacity acc. to UL/CSA	1 or 2 x		AWG 16...10	AWG 16...6
Stripping length			10 mm	12 mm
Tightening torque			1.5 Nm / 13 lb.in	2.5 Nm / 22 lb.in
<b>Auxiliary conductors (coil terminals)</b>				
 Rigid solid		1 x	1...2.5 mm <sup>2</sup>	
 Rigid solid		2 x	1...2.5 mm <sup>2</sup>	
 Flexible with non insulated ferrule		1 x	0.75...2.5 mm <sup>2</sup>	
 Flexible with non insulated ferrule		2 x	0.75...2.5 mm <sup>2</sup>	
 Flexible with insulated ferrule		1 x	0.75...2.5 mm <sup>2</sup>	
 Flexible with insulated ferrule		2 x	0.75...1.5 mm <sup>2</sup>	
 Lugs		L <	8 mm	
Connection capacity acc. to UL/CSA	1 or 2 x		AWG 18...14	
Stripping length			10 mm	
Tightening torque			1.2 Nm / 11 lb.in	
<b>Degree of protection</b>				
acc. to IEC 60947-1 / EN 60947-1 and IEC 60529 / EN 60529				
Main terminals	IP20			
Coil terminals	IP20			
<b>Screw terminals</b>	Delivered in open position, screws of unused terminals must be tightened			
Main terminals			M3.5	M4.5
	<b>Screwdriver type</b>	Flat Ø 5.5 / Pozidriv 2		
Coil terminals			M3.5	
	<b>Screwdriver type</b>	Flat Ø 5.5 / Pozidriv 2		

# NF control relays

## Technical data

### Contact utilization characteristics according to IEC

Control relay types	AC / DC operated	NF
Standards		IEC 60947-1 / 60947-5-1 and EN 60947-1 / 60947-5-1
Rated operational voltage $U_e$ max.		690 V
Rated frequency (without derating)		50 / 60 Hz
Conventional free-air thermal current $I_{th} \theta \leq 40^\circ\text{C}$		16 A
<b>2</b> $I_e$ / Rated operational current AC-15 acc. to IEC 60947-5-1		
	24-127 V 50/60 Hz	6 A
	220-240 V 50/60 Hz	4 A
	400-440 V 50/60 Hz	3 A
	500 V 50/60 Hz	2 A
	690 V 50/60 Hz	2 A
Rated making capacity AC-15		10 x $I_e$ AC-15 acc. to IEC 60947-5-1
Rated breaking capacity AC-15		10 x $I_e$ AC-15 acc. to IEC 60947-5-1
$I_e$ / Rated operational current DC-13 acc. to IEC 60947-5-1		
	24 V DC	6 A / 144 W
	48 V DC	2.8 A / 134 W
	72 V DC	1 A / 72 W
	110 V DC	0.55 A / 60 W
	125 V DC	0.55 A / 69 W
	220 V DC	0.27 A / 60 W
	250 V DC	0.27 A / 68 W
	400 V DC	0.15 A / 60 W
	500 V DC	0.13 A / 65 W
	600 V DC	0.1 A / 60 W
Short-circuit protection device gG type fuse		10 A
Rated short-time withstand current $I_{cw}$	for 1.0 s	100 A
	for 0.1 s	140 A
Minimum switching capacity		12 V / 3 mA
with failure rate acc. to IEC 60947-5-4		$10^{-7}$
Non-overlapping time between N.O. and N.C. contacts		$\geq 2$ ms
Power dissipation per pole at 6 A		0.1 W
Max. electrical switching frequency	AC-15	1200 cycles/h
	DC-13	900 cycles/h
Mechanically linked contacts acc. to annex L of IEC 60947-5-1		Built-in N.O. or N.C. auxiliary contacts and additional N.O. or N.C. auxiliary contacts (CA4, CAL4 aux. contact blocks) are mechanically linked contacts.

### Contact utilization characteristics according to UL / CSA

Control relay types	AC / DC operated	NF
Standards		UL 60947-1 / 60947-4-1A and CSA 60947-1 / 60947-4-1A
Max. operational voltage		600 V AC, 600 V DC
Pilot duty		A600, Q600
AC thermal rated current		10 A
AC maximum volt-ampere making		720 VA
AC maximum volt-ampere breaking		720 VA
DC thermal rated current		2.5 A
DC maximum volt-ampere making-breaking		69 VA



# NF control relays

## Technical data

### General technical data

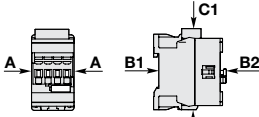
<b>Control relay types</b>	AC / DC operated	NF
<b>Rated insulation voltage <math>U_i</math></b>		690 V
acc. to IEC 60947-5-1		600 V
acc. to UL / CSA		6 kV
<b>Rated impulse withstand voltage <math>U_{imp}</math></b>		6 kV
<b>Electromagnetic compatibility</b>		Devices complying with IEC 60947-1 / EN 60947-1 - Environment A
<b>Ambient air temperature</b> close to contactor relay		
Operation in free air		-40...+70 °C
Storage		-60...+80 °C
<b>Climatic withstand</b>		Category B according to IEC 60947-1 Annex Q
<b>Maximum operating altitude (without derating)</b>		3000 m
<b>Mechanical durability</b>		
Number of operating cycles		20 millions operating cycles
Max. switching frequency		6000 cycles/h
<b>Shock withstand</b>		
acc. to IEC 60068-2-27 and EN 60068-2-27		
Mounting position 1		
	<b>Shock direction</b>	1/2 sinusoidal shock for 11 ms: no change in contact position, closed or open position
	A	30 g
	B1	25 g closed position / 5 g open position
	B2	15 g
	C1	25 g
	C2	25 g
<b>Vibration withstand</b>		5...300 Hz
acc. to IEC 60068-2-6		4 g closed position / 2 g open position

### Magnet system characteristics

<b>Control relay types</b>	AC / DC operated	NF
<b>Coil operating limits</b>	AC supply	At $\theta \leq 60$ °C $0.85 \times U_c \text{ min...} 1.1 \times U_c \text{ max.}$
acc. to IEC 60947-5-1	DC supply	At $\theta \leq 70$ °C $0.85 \times U_c \text{ min...} U_c \text{ max.}$
		At $\theta \leq 60$ °C $0.85 \times U_c \text{ min...} 1.1 \times U_c \text{ max.}$
		At $\theta \leq 70$ °C (AF) $0.85 \times U_c \text{ min...} U_c \text{ max.}$ - (NFZ) $0.85 \times U_c \text{ min...} 1.1 \times U_c \text{ max.}$
<b>AC control voltage 50/60 Hz</b>		
Rated control circuit voltage $U_c$		24...500 V AC
Coil consumption	<b>Average pull-in value</b>	(NF) 50 VA - (NFZ) 16 VA
	<b>Average holding value</b>	(NF) 2.2 VA / 2 W - (NFZ) 1.7 VA / 1.5 W
<b>DC control voltage</b>		
Rated control circuit voltage $U_c$		12...500 V DC
Coil consumption	<b>Average pull-in value</b>	(NF) 50 W - (NFZ) 12...16 W
	<b>Average holding value</b>	(NF) 2 W - (NFZ) 1.7 W
<b>PLC-output control</b>		(NFZ) $\geq 500$ mA 24 V DC
<b>Drop-out voltage</b>		$\leq 60$ % of $U_c \text{ min.}$
<b>Voltage sag immunity</b>		
acc. to SEMI F47-0706		(NFZ) conditions of use on request
<b>Dips withstand</b>		
-20 °C $\leq$ $\leq$ +60 °C		(NFZ) 22 ms average for $U_c \geq 24$ V 50/60 Hz or $U_c \geq 20$ V DC
<b>Operating time</b>		
Between coil energization and:	<b>N.O. contact closing</b>	40...95 ms
	<b>N.C. contact opening</b>	38...90 ms
Between coil de-energization and:	<b>N.O. contact opening</b>	11...95 ms
	<b>N.C. contact closing</b>	13...98 ms



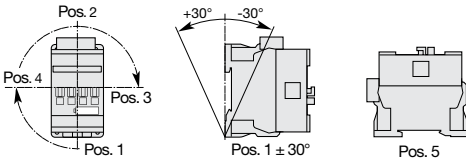





### Mounting characteristics

<b>Control relay types</b>	AC / DC operated	NF
<b>Mounting positions</b>		
<b>Mounting distances</b>		Max. add-on N.C. auxiliary contacts: see accessory fitting details for a NF contactor relay
<b>Fixing</b>		The contactor relays can be assembled side by side.
On rail according to IEC 60715, EN 60715		35 x 7.5 mm or 35 x 15 mm
By screws (not supplied)		2 x M4 screws placed diagonally

# NF control relays

## Technical data

### Connecting characteristics

Control relay types	AC / DC operated	NF
Main terminals		 Screw terminals with cable clamp
<b>2</b> Connection capacity (min. ... max.)		
<b>Pole and coil terminals</b>		
 Rigid	1 x	1...2.5 mm <sup>2</sup>
 Rigid	2 x	1...2.5 mm <sup>2</sup>
 Flexible with non insulated ferrule	1 x	0.75...2.5 mm <sup>2</sup>
 Flexible with non insulated ferrule	2 x	0.75...2.5 mm <sup>2</sup>
 Flexible with insulated ferrule	1 x	0.75...2.5 mm <sup>2</sup>
 Flexible with insulated ferrule	2 x	0.75...1.5 mm <sup>2</sup>
 Lugs	L <	8 mm
Connection capacity acc. to UL/CSA	1 or 2 x	AWG 18...14
Stripping length		10 mm
<b>Tightening torque</b>		
Pole terminals		1.2 Nm / 11 lb.in
Coil terminals		1.2 Nm / 11 lb.in
<b>Degree of protection</b>		
acc. to IEC 60947-1 / EN 60947-1 and IEC 60529 / EN 60529		
All terminals		IP20
<b>Screw terminals</b>		
All terminals		Delivered in open position, screws of unused terminals must be tightened
		M3.5
	<b>Screwdriver type</b>	Fiat Ø 5.5 / Pozidriv 2

# Auxiliary contact blocks for AF09 ... AF96 contactors and NF control relays

## Technical data





### Contact utilization characteristics according to IEC

Types	1-pole <b>CA4</b> , 1-pole <b>CC4</b> , 4-pole <b>CA4</b> , 2-pole <b>CAT4</b> , 2-pole <b>CAL4</b>	
Standards	IEC 60947-5-1 and EN 60947-5-1	
Rated insulation voltage $U_i$ acc. to IEC 60947-5-1	690 V	
Rated impulse withstand voltage $U_{imp}$	6 kV	
Rated operational voltage $U_e$ max.	24...690 V	
Conventional thermal current $I_{th}$ - $\leq 40^\circ\text{C}$	16 A	
Rated frequency (without derating)	50/60 Hz	
$I_e$ / Rated operational current AC-15 acc. to IEC 60947-5-1	24-127 V 50/60 Hz	6 A
	220-240 V 50/60 Hz	4 A
	400-440 V 50/60 Hz	3 A
	500 V 50/60 Hz	2 A
	690 V 50/60 Hz	2 A
Making capacity acc. to IEC 60947-5-1	10 x $I_e$ AC-15	
Breaking capacity acc. to IEC 60947-5-1	10 x $I_e$ AC-15	
$I_e$ / Rated operational current DC-13 acc. to IEC 60947-5-1	24 V DC	6 A / 144 W
	48 V DC	2.8 A / 134 W
	72 V DC	1 A / 72 W
	110 V DC	0.55 A / 60 W
	125 V DC	0.55 A / 69 W
	220 V DC	0.27 A / 60 W
	250 V DC	0.27 A / 68 W
	400 V DC	0.15 A / 60 W
	500 V DC	0.13 A / 65 W
	600 V DC	0.1 A / 60 W
Short-circuit protection device gG type fuse	10 A	
Rated short-time withstand current $I_{cw}$ = $40^\circ\text{C}$	for 1.0 s	100 A
	for 0.1 s	140 A
Minimum switching capacity with failure rate acc. to IEC 60947-5-4	12 V / 3 mA	
Power dissipation per pole at 6 A	0.1 W	
Mechanical durability	Number of operating cycles	10 millions operating cycles
	Max. switching frequency	3600 cycles/h
Max. electrical switching frequency	AC-15	1200 cycles/h
	DC-13	900 cycles/h
Mechanically linked contacts acc. to annex L of IEC 60947-5-1	Additional N.O. or N.C. auxiliary contacts (CA4, CAL4, CAT4) are mechanically linked contacts	
Mirror contacts acc. to annex F of IEC 60947-4-1	Additional N.C. auxiliary contacts (CA4, CAL4, CAT4) are mirror contacts	

### Contact utilization characteristics according to UL / CSA

Types	1-pole <b>CA4</b> , 1-pole <b>CC4</b> , 4-pole <b>CA4</b> , 2-pole <b>CAT4</b> , 2-pole <b>CAL4</b>	
Standards	UL 60947-1 / 60947-4-1A and CSA 60947-1 / 60947-4-1A	
Max. operational voltage	600 V AC, 600 V DC	
Pilot duty	A600, Q600	
AC thermal rated current	10 A	
AC maximum volt-ampere making	7200 VA	
AC maximum volt-ampere breaking	720 VA	
DC thermal rated current	2.5 A	
DC maximum volt-ampere making-breaking	69 VA	

### Connecting characteristics

Types	1-pole <b>CA4</b> , 1-pole <b>CC4</b> , 4-pole <b>CA4</b> , 2-pole <b>CAT4</b> , 2-pole <b>CAL4</b>	
Connection capacity (min. ... max.)		
 Rigid solid	1 x	1...2.5 mm <sup>2</sup>
	2 x	1...2.5 mm <sup>2</sup>
 Flexible with non insulated ferrule	1 x	0.75...2.5 mm <sup>2</sup>
	2 x	0.75...2.5 mm <sup>2</sup>
 Flexible with insulated ferrule	1 x	0.75...2.5 mm <sup>2</sup>
	2 x	0.75...1.5 mm <sup>2</sup>
 Lugs	L <	8 mm
Connection capacity acc. to UL/CSA	1 or 2 x	AWG 18...14
Stripping length	10 mm	
Tightening torque	1.2 Nm / 11 lb.in	
Degree of protection acc. to IEC 60947-1 / EN 60947-1 and IEC 60529 / EN 60529	IP20	
Screw terminals	Delivered in open position, screws of unused terminals must be tightened	
All terminals	M3.5	
Screwdriver type	Flat $\varnothing$ 5.5 / Pozidriv 2	

# Auxiliary contact blocks for AF116 ... AF2650 contactors

## Technical data

Types	CAL18	CAL19
-------	-------	-------







### Contact utilization characteristics according to IEC

Standards	IEC 60947-5-1 and EN 60947-5-1	
Rated insulation voltage $U_i$ acc. to IEC 60947-5-1	690 V	
Rated impulse withstand voltage $U_{imp}$	6 kV	
Rated operational voltage $U_e$ max.	24...690 V AC	
Conventional thermal current $I_{th}$ - $\leq 40^\circ\text{C}$	16 A	
Rated frequency (without derating)	50/60 Hz	
$I_e$ / Rated operational current AC-15		
acc. to IEC 60947-5-1	24-127 V 50/60 Hz	6 A
	220-240 V 50/60 Hz	4 A
	380-440 V 50/60 Hz	3 A
	500-690 V 50/60 Hz	2 A
Making capacity acc. to IEC 60947-5-1	10 x $I_e$ AC-15	
Breaking capacity acc. to IEC 60947-5-1	10 x $I_e$ AC-15	
$I_e$ / Rated operational current DC-13		
acc. to IEC 60947-5-1	24 V DC	6 A / 144 W
	48 V DC	2.8 A / 134 W
	72 V DC	1 A / 72 W
	110 V DC	0.55 A / 60 W
	125 V DC	0.55 A / 69 W
	220 V DC	0.3 A / 66 W
	250 V DC	0.3 A / 75 W
Short-circuit protection device gG type fuse	10 A	
Rated short-time withstand current $I_{sw}$	for 1.0 s	100 A
= $40^\circ\text{C}$	for 0.1 s	140 A
Minimum switching capacity	24 V / 50 mA (0.5 million of operating cycles)	24 V / 50 mA
with failure rate acc. to IEC 60947-5-4	$\leq 10^{-6}$	
Power dissipation per pole at 6 A	0.15 W	
Mechanical durability	Number of operating cycles	3 millions (A/AF400 ... AF750)
	Max. switching frequency	0.5 million (AF1250 ... AF2050)
		3600 cycles/h
Max. electrical switching frequency	AC-15	1200 cycles/h
	DC-13	900 cycles/h
		300 cycles/h
Mechanically linked contacts acc. to annex L of IEC 60947-5-1	N.O. or N.C. auxiliary contacts are mechanically linked contacts	
Mirror contacts acc. to annex F of IEC 60947-4-1	N.C. auxiliary contacts are mirror contacts	

### Contact utilization characteristics according to UL / CSA

Standards	UL 60947-1 / 60947-4-1A and CSA 60947-1 / 60947-4-1A
Max. operational voltage	600 V AC, 250 V DC
Pilot duty	A600, Q300
AC thermal rated current	10 A
AC maximum volt-ampere making	7200 V A
AC maximum volt-ampere breaking	720 V A
DC thermal rated current	2.5 A
DC maximum volt-ampere making-breaking	69 V A

### Connecting characteristics

Connection capacity (min. ... max.)		
 Solid / stranded	1 x	1...4 mm <sup>2</sup>
 Flexible with non insulated ferrule	2 x	1...4 mm <sup>2</sup>
 Flexible with insulated ferrule	1 x	0.75...2.5 mm <sup>2</sup>
 Flexible with insulated ferrule	2 x	0.75...2.5 mm <sup>2</sup>
 Flexible with insulated ferrule	1 x	0.75...2.5 mm <sup>2</sup>
 Flexible with insulated ferrule	2 x	0.75...2.5 mm <sup>2</sup>
 Lugs	L $\leq$	8 mm
	L $>$	3.7 mm
Connection capacity acc. to UL/CSA	1 or 2 x	AWG18...14
Stripping length	9 mm	
Tightening torque	1 Nm	
Degree of protection	IP20	
acc. to IEC 60947-1 / EN 60947-1 and IEC 60529 / EN 60529		
Screw terminals	Delivered in open position, screws of unused terminals must be tightened	
All terminals	M3.5	
Screwdriver type	Flat $\varnothing$ 5.5 / Pozidriv 2	

# Auxiliary contact blocks for AF09 ... AF96 contactors and NF control relays for severe industrial environments

## Technical data

Types	Front mounted 1-pole CE5-..0.1	1-pole CE5-..2
-------	-----------------------------------	----------------





## Contact utilization characteristics according to IEC

Standards	IEC 60947-5-1 and EN 60947-5-1	
Rated insulation voltage Ui acc. to IEC 60947-5-1	250 V	
Rated operational voltage Ue max.	125 V	250 V
Conventional thermal current Ith - $\theta \leq 40^\circ\text{C}$	0.1 A	2 A
Rated frequency (without derating)	50 / 60 Hz	
Ie / Rated operational current	AC-14	AC-15
acc. to IEC 60947-5-1	24-127 V 50/60 Hz 0.1 A	2 A
	220-240 V 50/60 Hz -	2 A
Making capacity	6 x Ie AC-14 acc. to IEC 60947-5-1	10 x Ie AC-15 acc. to IEC 60947-5-1
Breaking capacity	6 x Ie AC-14 acc. to IEC 60947-5-1	10 x Ie AC-15 acc. to IEC 60947-5-1
Ie / Rated operational current DC-12 acc. to IEC 60947-5-1	24 V DC 0.1 A	2 A
	48 V DC 0.1 A	1 A
	72 V DC 0.1 A	0.3 A
	110 V DC 0.1 A	0.2 A
	125 V DC -	0.2 A
	220 V DC -	0.1 A
Short-circuit protection device FF type fuse (1)	0.1 A	
Minimum switching capacity		
AF09 ... AF38 contactors with failure rate acc. to IEC 60947-5-4	3 V / 1 mA -	17 V / 1 mA $\leq 10^7$
Mechanical durability		
Number of operating cycles	5 millions for CE5-..D0.1 2.5 millions for CE5-..W0.1	5 millions for CE5-..D2 2.5 millions for CE5-..W2
Max. switching frequency	3600 cycles/h	
Electrical durability		
Number of operating cycles	2.5 millions for CE5-..D0.1 0.7 millions for CE5-..W0.1	1 million for CE5-..D2 0.3 millions for CE5-..W2
Max. electrical switching frequency	AC-14 AC-15 DC-12	1200 cycles/h 1200 cycles/h 900 cycles/h

## Contact utilization characteristics according to UL / CSA

Standards	UL 60947-1 / 60947-4-1A and CSA 60947-1 / 60947-4-1A	
Max. operational voltage	125 V AC / 110 V DC	250 V AC / 220 V DC
Pilot duty		
AC thermal rated current	0.1 A	2 A

## Connecting characteristics

Connection capacity (min. ... max.)		
 Rigid solid	1 x	1...4 mm <sup>2</sup>
 Flexible with ferrule	2 x	1...4 mm <sup>2</sup>
 Flexible with ferrule	1 x	0.75...2.5 mm <sup>2</sup>
 Flexible with ferrule	2 x	0.75...2.5 mm <sup>2</sup>
 Lugs	L $\leq$	7.7 mm
	I $>$	3.7 mm
Connecting capacity acc. to UL / CSA	1 or 2 x	AWG 18...14
Tightening torque	1 Nm	
Degree of protection	Terminals	IP20
acc. to IEC 60947-1 / EN 60947-1 and IEC 60529 / EN 60529	Microswitches	IP40 for CE5-..D0.1 IP67 for CE5-..W0.1
		IP40 for CE5-..D2 IP67 for CE5-..W2
Screw terminals	Delivered in open position, screws of unused terminals must be tightened	
All terminals	M3.5	
Screwdriver type	Flat $\varnothing$ 5.5 / Pozidriv 2	

(1) HRC fuses for very fast action (6.3 x 32 mm size).

# Auxiliary contact blocks for AF400 ... AF2650 contactors for severe industrial environments

## Technical data

Types	CEL18
-------	-------

### Contact utilization characteristics according to IEC





2

<b>Standards</b>	IEC 60947-5-1 and EN 60947-5-1	
Rated insulation voltage $U_i$ acc. to IEC 60947-5-1	250 V	
Rated operational voltage $U_e$ max.	125 V	
Conventional thermal current $I_{th}$ - $\theta \leq 40^\circ\text{C}$	0.1 A	
le / Rated operational current AC-14		
acc. to IEC 60947-5-1	24-127 V 50/60 Hz	0.1 A
Making capacity acc. to IEC 60947-5-1	6 x $I_e$ AC-14	
Breaking capacity acc. to IEC 60947-5-1	6 x $I_e$ AC-14	
le / Rated operational current DC-12		
acc. to IEC 60947-5-1	24 V DC	0.1 A
	48 V DC	0.1 A
	72 V DC	0.1 A
	110 V DC	0.1 A
	220 V DC	-
Short-circuit protection device	0.1 A (FF type fuses) (1)	
Minimum switching capacity		
with failure rate acc. to IEC 60947-5-4	3 V / 1 mA	
Mechanical durability	Number of operating cycles	1 million
	Max. switching frequency	1200 cycles/h
Electrical durability	Number of operating cycles	0.7 millions
	Max. switching frequency	AC-14, AC15 DC-12 1200 cycles/h 900 cycles/h

### Contact utilization characteristics according to UL / CSA

<b>Standards</b>	UL 60947-1 / 60947-4-1A and CSA 60947-1 / 60947-4-1A
Max. operational voltage	125 V
Pilot duty	
AC thermal rated current	0.1 A

### Connecting characteristics

<b>Connection capacity (min. ... max.)</b>		
	Rigid solid	1 x 1...4 mm <sup>2</sup>
	Flexible with ferrule	2 x 1...4 mm <sup>2</sup>
		1 x 0.75...2.5 mm <sup>2</sup>
	Lugs	2 x 0.75...2.5 mm <sup>2</sup>
		$L \leq 7.7$ mm
		$l > 3.7$ mm
Connection capacity acc. to UL/CSA	1 or 2 x	AWG 18...14
Tightening torque		1 Nm
Degree of protection	Terminals	IP20
acc. to IEC 60947-1 / EN 60947-1 and IEC 60529 / EN 60529	Microswitches	IP67
Screw terminals	Delivered in open position, screws of unused terminals must be tightened	
All terminals	M3.5	
Screwdriver type	Flat $\varnothing 5.5$ / Pozidriv 2	

(1) or HRC fuses for very fast action (6.3 x 32 mm size).

# Electronic timers

## Technical data

### Contact utilization characteristics according to IEC

Types	TEF4-ON	TEF4-OFF
<b>Standards</b>	IEC 60947-5-1 and EN 60947-5-1	
Rated insulation voltage $U_i$ acc. to IEC 60947-5-1	400 V	
Rated impulse withstand voltage $U_{imp}$	4 kV	
Rated operational voltage $U_e$ max.	240 V	
Rated frequency (without derating)	50 / 60 Hz	
Conventional thermal current $I_{th} - \leq 40^\circ C$	5 A	
$I_e$ / Rated operational current AC-15 acc. to IEC 60947-5-1	24-127 V 50/60 Hz	3 A
	220-240 V 50/60 Hz	1.5 A
Making capacity acc. to IEC 60947-5-1	10 x $I_e$ AC-15	
Breaking capacity acc. to IEC 60947-5-1	10 x $I_e$ AC-15	
$I_e$ / Rated operational current DC-13 acc. to IEC 60947-5-1	24 V DC	1 A / 24 W
	Short-circuit protection device gG type fuse	6 A
Rated short-time withstand current $I_{cw}$ = 40 °C	for 1.0 s	8 A
	for 0.1 s	8 A
Minimum switching capacity with failure rate acc. to IEC 60947-5-4	24 V DC	12 V / 3 mA $10^{-7}$
Power dissipation per pole at 3 A	0.1 W	
Function diagram	ON-delay	OFF-delay
Bistable relay inside. Before use, once apply $U_c$ then switch it off in order to initialize position of the contacts.		
<b>Control circuit voltage</b>		
AC control voltage 50/60 Hz	Rated control circuit voltage $U_c$	24...240 V AC
	Average consumption	1.5 mA RMS
DC control voltage	Rated control circuit voltage $U_c$	24...240 V DC
	Average consumption	1.5 mA
Rated frequency limits	50 / 60 Hz	
Supply voltage range	0.85...1.1 x $U_c$ (at $\leq 70^\circ C$ )	
Overvoltage protection	Varistor included	
Time delay range (t) selected by switch	0.1...1 s	<input type="checkbox"/>
	1...10 s	<input type="checkbox"/>
	10...100 s	<input type="checkbox"/>
On-load reiteration accuracy under constant conditions	$\leq 1\%$	
Minimum ON period	0.1 s	1 s
Recovery time	0.15 s	0.1 s
Ambient air temperature	Operation	-25 °C ... +70 °C
	Storage	-40 °C ... +80 °C
Climatic withstand	Category B according to IEC 60947-1 Annex Q	
Maximum operating altitude	2000 m	
Mounting positions	Mounting positions 1, 1 +/- 30°, 2, 3, 4, 5	
Shock withstand	1/2 sinusoidal shock for 11 ms: no change in contact position	
acc. to IEC 60068-2-27 and EN 60068-2-27 (Mounting position 1)	Same as contactor or contactor relay	
Vibration withstand	5...300 Hz	
acc. to IEC 60068-2-6	3 g closed position / 2 g open position	
Mechanical durability	Number of operating cycles	5 millions operating cycles
	Max. switching frequency	3600 cycles/h
Max. electrical switching frequency	AC-15	1200 cycles/h
	DC-13	900 cycles/h

# Electronic timers







## Technical data

2

### Contact utilization characteristics according to UL / CSA

Types	TEF4-ON	TEF4-OFF
Standards	UL 60947-1 / 60947-4-1A and CSA 60947-1 / 60947-4-1A	
Rated insulation voltage $U_i$ acc. to UL / CSA	300 V	
Max. operational voltage	240 V	
Pilot duty	B300, R300	
AC thermal rated current	5 A	
AC maximum volt-ampere making	3600 VA	
AC maximum volt-ampere breaking	360 VA	
DC thermal rated current	1 A	
DC maximum volt-ampere making-breaking	28 VA	

### Connecting characteristics

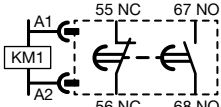
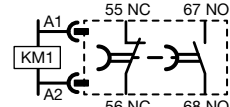
Connection capacity (min. ... max.)		
 Rigid solid	1 x	1...2.5 mm <sup>2</sup>
 Flexible with non insulated ferrule	2 x	1...2.5 mm <sup>2</sup>
 Flexible with non insulated ferrule	1 x	0.75...2.5 mm <sup>2</sup>
 Flexible with insulated ferrule	2 x	0.75...2.5 mm <sup>2</sup>
 Flexible with insulated ferrule	1 x	0.75...2.5 mm <sup>2</sup>
 Flexible with insulated ferrule	2 x	0.75...1.5 mm <sup>2</sup>
 Lugs	L ≤	8 mm
	L >	3.7 mm
Connection capacity acc. to UL / CSA	1 or 2 x	AWG 18...14
Stripping length		10 mm
Tightening torque		1.2 N.m / 11 lb.in
Degree of protection acc. to IEC 60947-1 / EN 60947-1 and IEC 60529 / EN 60529		IP20
Screw terminals		Delivered in open position, screws of unused terminals should be tightened
All terminals		M3.5
Screwdriver type		Flat Ø 5.5 / Pozidriv 2
Terminal Marking		



# Interlocks

## Technical data

### Mechanical interlock unit

Types		VM4, VM96	VM19 ... VM750	VM1650H
Mechanical durability	Number of operating cycles	5 millions operating cycles	1 million operating cycles	500 000 operating cycles
	Max. mechanical switching frequency	1800 cycles/h	300 cycles/h	

2

### Mechanical and electrical interlock set





#### Contact utilization characteristics according to IEC

Types		VEM4
Standards		IEC 60947-5-1 and EN 60947-5-1
Rated insulation voltage $U_i$ acc. to IEC 60947-5-1		690 V
Rated impulse withstand voltage $U_{imp}$ .		6 kV
Rated control circuit voltage $U_c$	AC 50/60 Hz control voltage	24...500 V AC
	DC control voltage	20...500 V DC
Conventional thermal current $I_{th}$ - $\leq 40^\circ\text{C}$		16 A
Mechanical durability	Number of operating cycles	5 millions operating cycles
	Max. mechanical switching frequency	1800 cycles/h
Electrical durability	Max. electrical switching frequency	1200 cycles/h

#### Contact utilization characteristics according to UL / CSA

Types		VEM4
Standards		UL 60947-1 / 60947-4-1A and CSA 60947-1 / 60947-4-1A
Max. operational voltage		500 V AC, 500 V DC

#### Connecting characteristics

Types		VEM4	
Connection capacity (min. ... max.)  Rigid solid  Flexible with ferrule  Flexible with insulated ferrule  Lugs			
		1 x	1...2.5 mm <sup>2</sup>
		2 x	1...2.5 mm <sup>2</sup>
		1 x	0.75...2.5 mm <sup>2</sup>
		2 x	0.75...2.5 mm <sup>2</sup>
	1 x	0.75...2.5 mm <sup>2</sup>	
	2 x	0.75...1.5 mm <sup>2</sup>	
	L <	8 mm	
Connection capacity acc. to UL / CSA	1 or 2 x	AWG 18...14	
Stripping length		10 mm	
Tightening torque		1.2 Nm / 11 lb.in	
Degree of protection		IP20	
acc. to IEC 60947-1 / EN 60947-1 and IEC 60529 / EN 60529			
Screw terminals		Delivered in open position, screws of unused terminals must be tightened	
All terminals		M3.5	
Screwdriver type		Flat Ø 5.5 / Pozidriv 2	

# Mechanical latching units

## Technical data



Type	WB75-A
------	--------

## Utilization characteristics according to IEC

2

Rated insulation voltage $U_i$ acc. to IEC 60947-1		690 V
Max. electrical impulse time		
On AC coil (with load factor 5 %)		20 s
On DC coil (with load factor 3 %)		8 s
Min. electrical impulse time		
For latching (energizing of the contactor coil)	AC	120 ms
	DC	120 ms
For pull-out (energizing of the WB block coil)	AC	30 ms
	DC	50 ms
Coil operating limits	AC or DC supply	0.85...1.1 x $U_c$
AC control voltage 50/60 Hz		
Rated control circuit voltage $U_c$		24...480 V AC
Coil consumption	Average pull-in value	90 VA
	Average holding value	60 VA
DC control voltage		
Rated control circuit voltage $U_c$		24...440 V DC
Coil consumption	Average pull-in value	110 W
	Average holding value	110 W
Operating time		
On contactor closing (latching)		
Between coil energization and:	N.O. contact closing	No difference with the operation of a contactor without mechanical latching unit
	N.C. contact opening	No difference with the operation of a contactor without mechanical latching unit
On contactor opening (unlatching)		
Between WB coil energization and:	N.O. contact opening	5...25 ms
	N.C. contact closing	7...28 ms
Mechanical durability	Number of operating cycles	1 million operating cycles
Max. switching frequency		3600 cycles/h with on-load factor of 8 %

## Connecting characteristics

Connection capacity (min. ... max.)		
 Rigid solid	1 x	1...4 mm <sup>2</sup>
	2 x	1...4 mm <sup>2</sup>
 Flexible with ferrule	1 x	0.75...2.5 mm <sup>2</sup>
	2 x	0.75...2.5 mm <sup>2</sup>
 Lugs	L <	8 mm
	I >	3.5 mm
Tightening torque		
Recommended		1 Nm
Max.		1.2 Nm
Screw terminals		Delivered in open position, screws of unused terminals must be tightened
All terminals		M3.5
Screwdriver type		Flat Ø 5.5 / Pozidriv 2

# AF09 ... AF96 3-pole contactors

## Terminal marking and positioning

### AF09 ... AF96 contactors - AC / DC operated

Standard devices without addition of auxiliary contacts

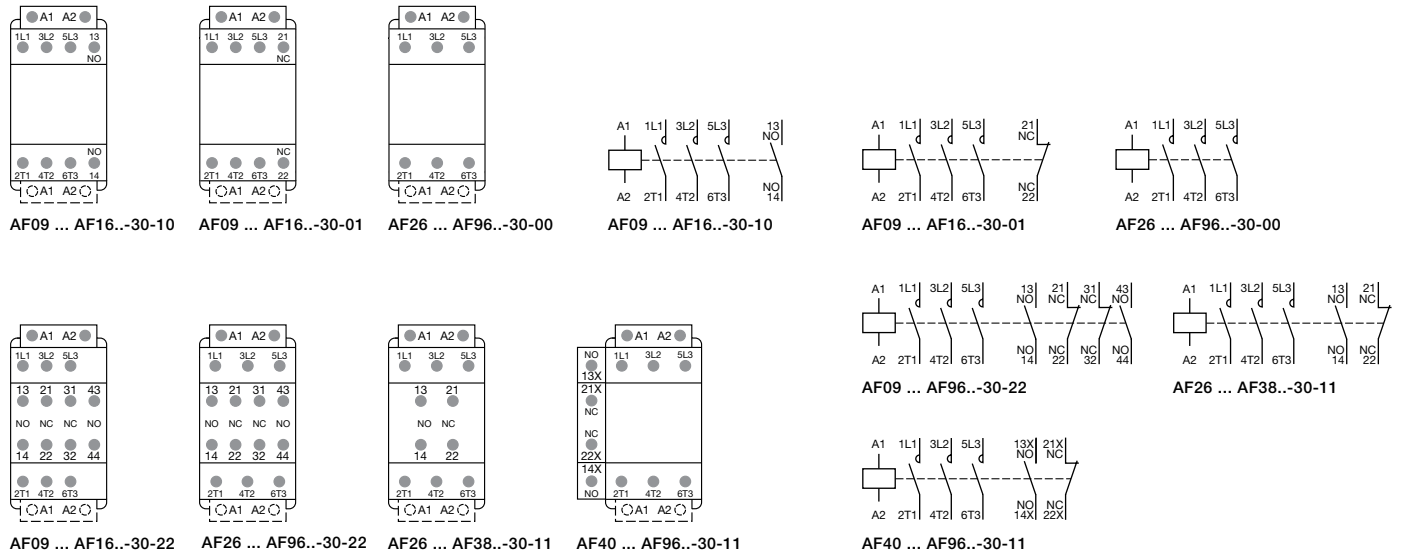

Other possible contact combinations with auxiliary contacts added by the user

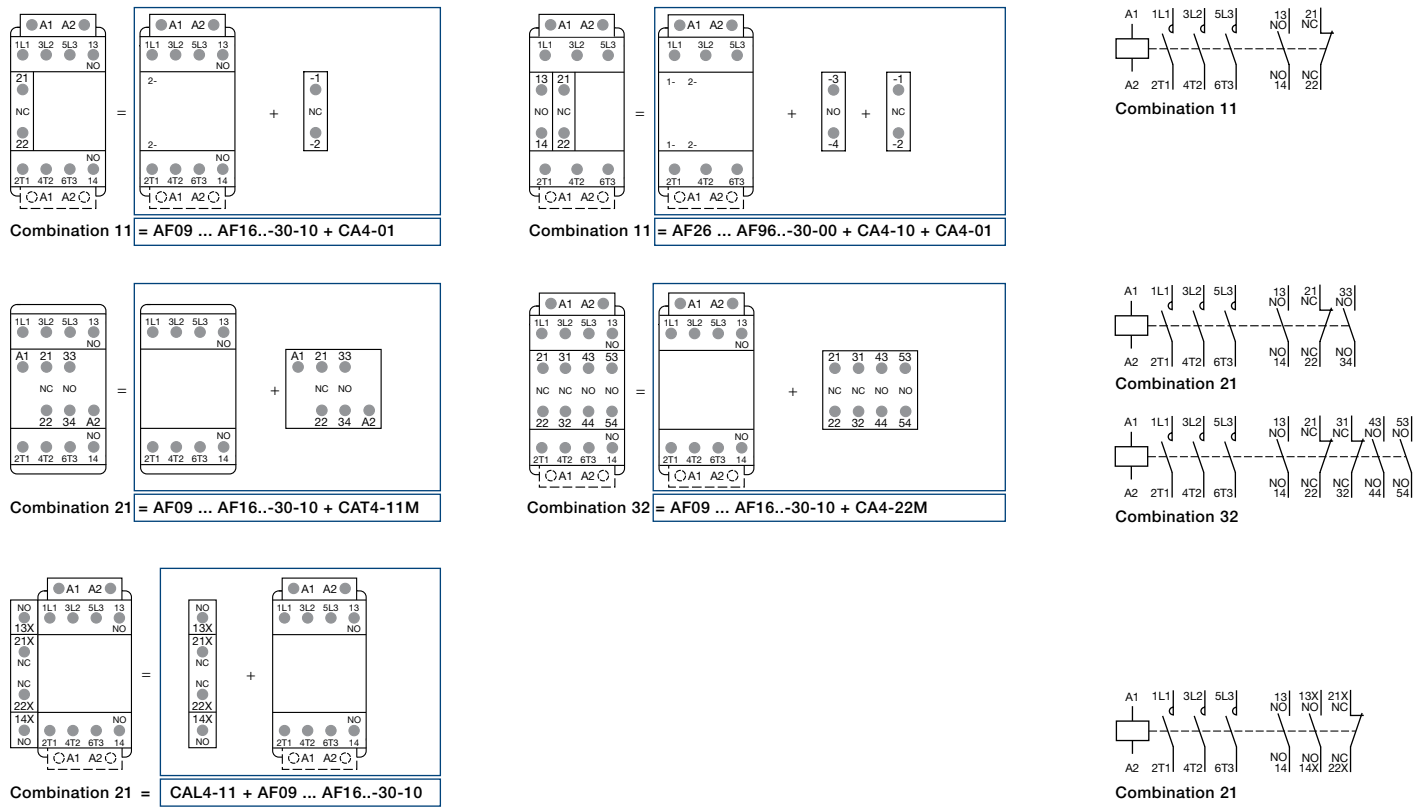

Note: Only AF.Z contactor with DC control voltage 12...20 V DC need to respect the connection polarities indicated close to the coil terminals: A1+ for the positive pole and A2- for the negative pole

# AF116 ... AF370 3-pole contactors

## Terminal marking and positioning

### AF116 ... AF370 contactors - AC / DC operated

Standard devices without addition of auxiliary contacts

2

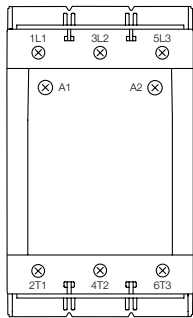

AF116 ... AF370-30-00

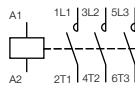

AF116 ... AF370-30-00

Standard devices with factory mounted auxiliary contacts

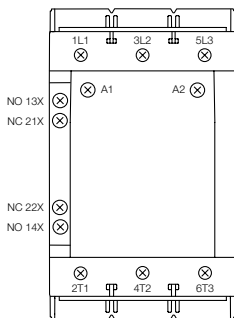

AF116 ... AF370-30-11

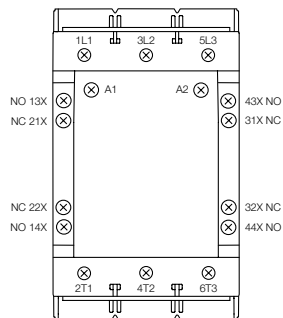

AF116 ... AF370-30-22



AF116 ... AF370-30-11

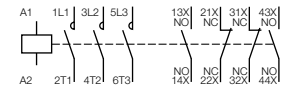

AF116 ... AF370-30-22

# AF400 ... AF2650 3-pole contactors

## Terminal marking and positioning

### AF400 ... AF1250 contactors - AC / DC operated

Standard devices with factory mounted auxiliary contacts

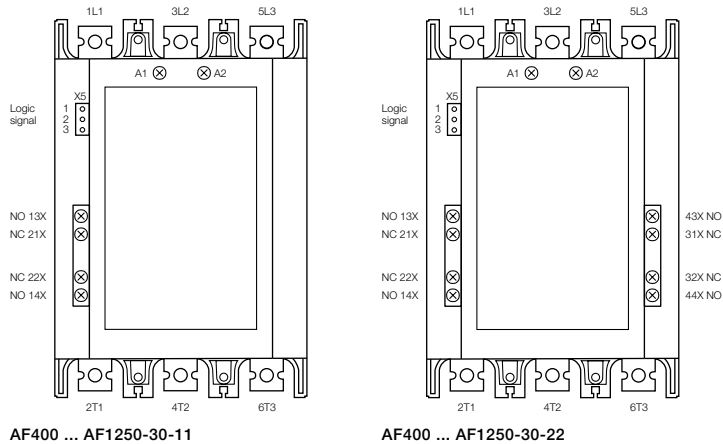

### Control with logic signal

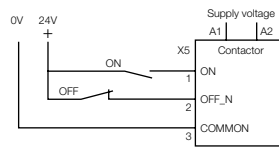

**AF400 ... AF1250-30-11, AF400 ... AF1250-30-22**

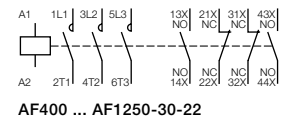
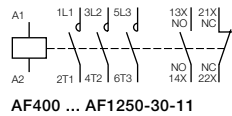

### AF1350 ... AF2650 contactors - AC / DC operated

Standard devices with factory mounted auxiliary contacts

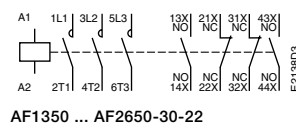
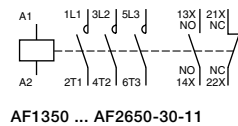
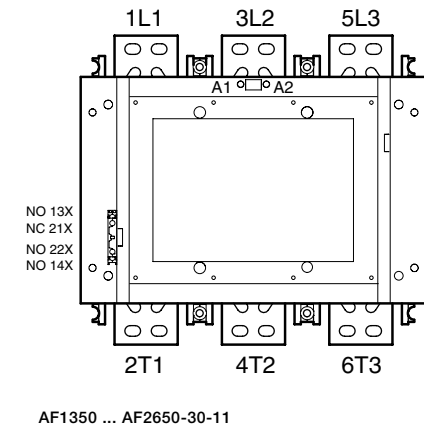

### Wiring diagrams

when used with transistor output

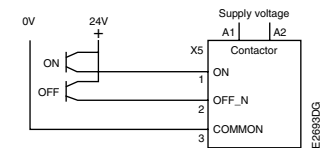

when used with transistor output

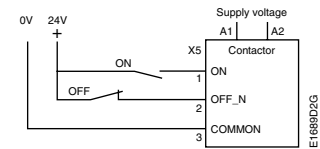

# AF09 ... AF38 4-pole contactors

## Terminal marking and positioning

2

### AF09 ... AF38 contactors - AC / DC operated

Standard devices without addition of auxiliary contacts

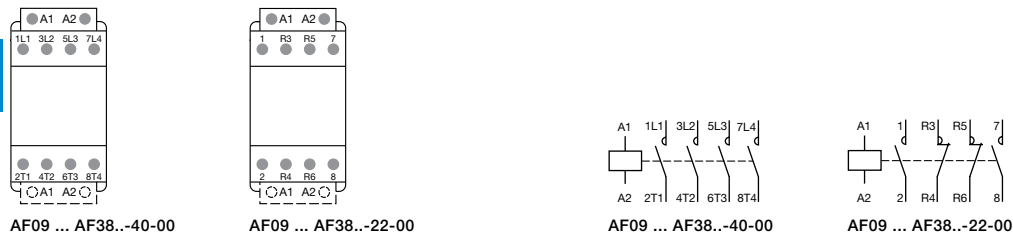

Other possible contact combinations with auxiliary contacts added by the user

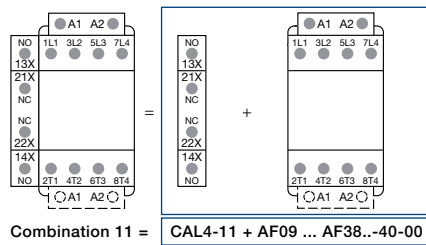
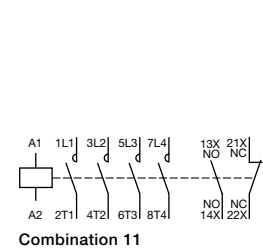
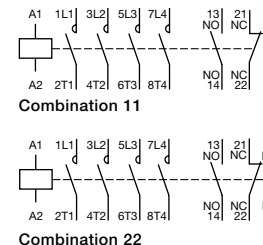
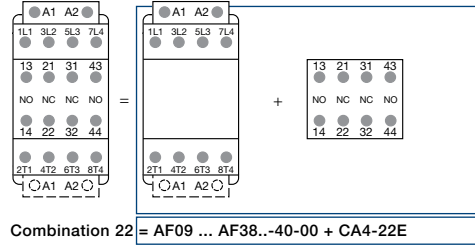
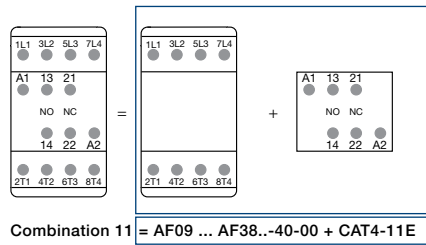
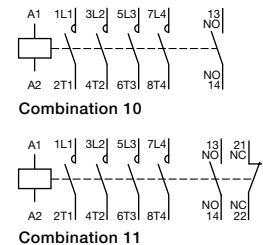
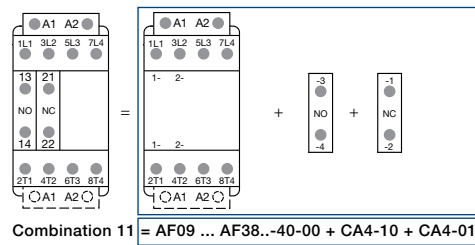
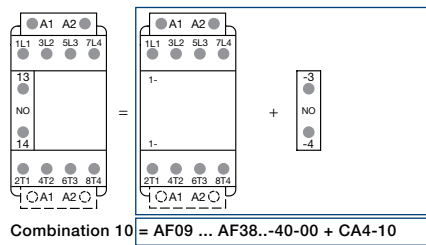

Note: Only AF.Z contactor with DC control voltage 12...20 V DC need to respect the connection polarities indicated close to the coil terminals: A1+ for the positive pole and A2- for the negative pole

# NF control relays

## Terminal marking and positioning

Standard devices without addition of auxiliary contacts

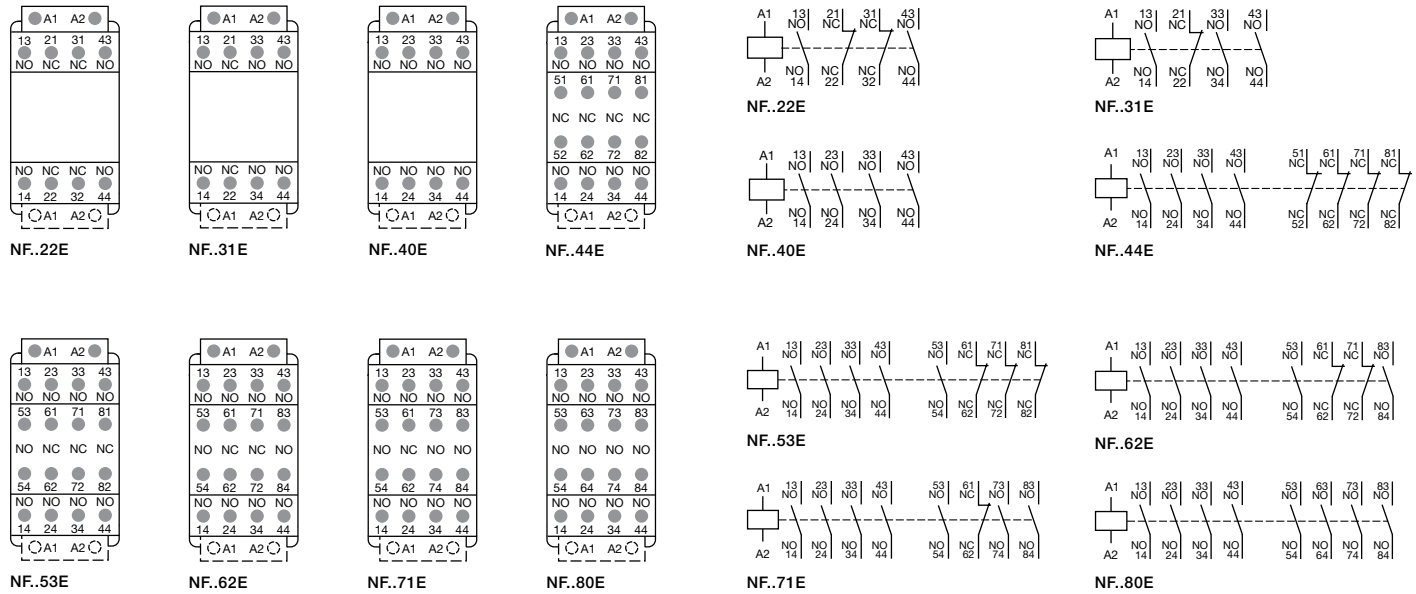

Other possible contact combinations with auxiliary contacts added by the user

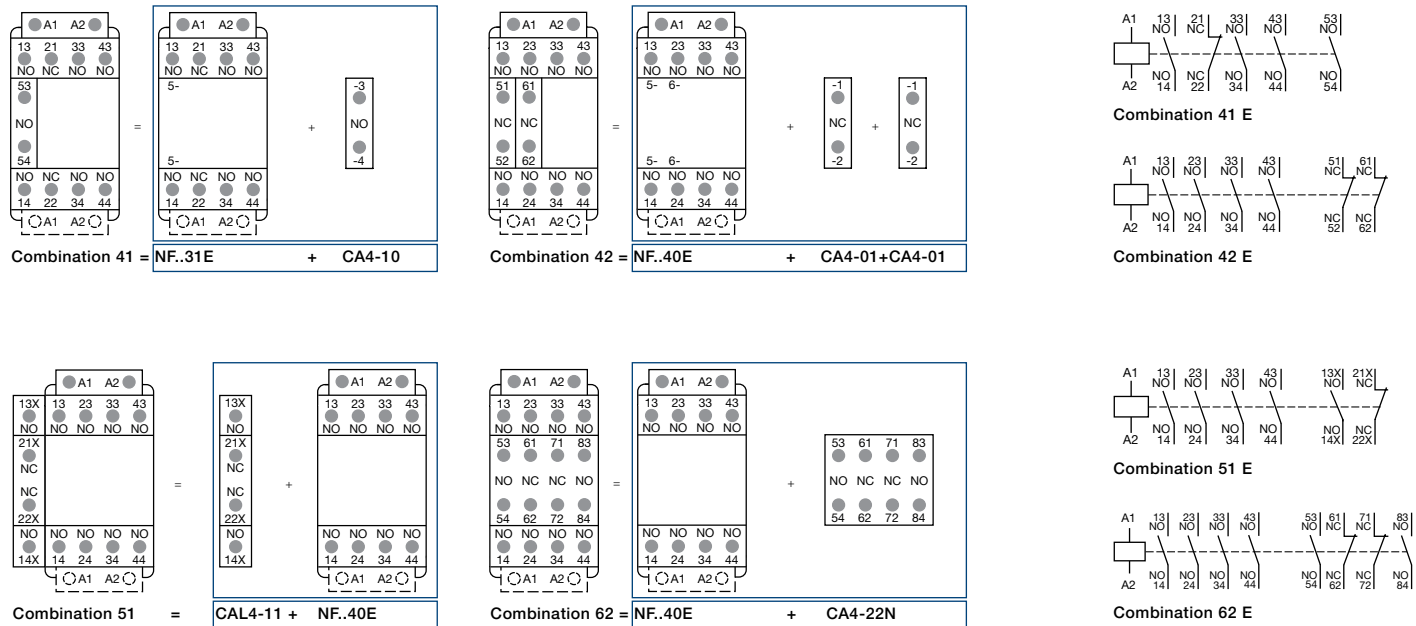

Note: Only NFZ control relays with DC control voltage 12...20 V DC need to respect the connection polarities indicated close to the coil terminals: A1+ for the positive pole and A2- for the negative pole

# Add-on auxiliary contacts

## Terminal marking and positioning

### 1-pole auxiliary contacts

2

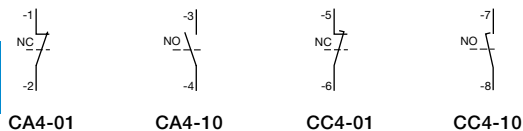

### 2-pole auxiliary contacts

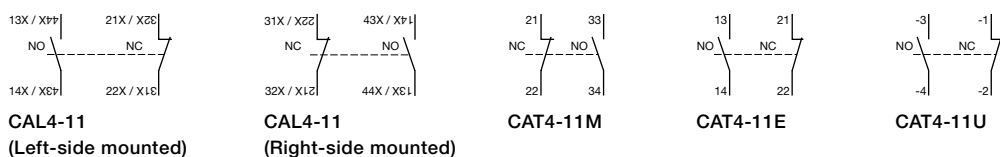

### 4-pole auxiliary contacts

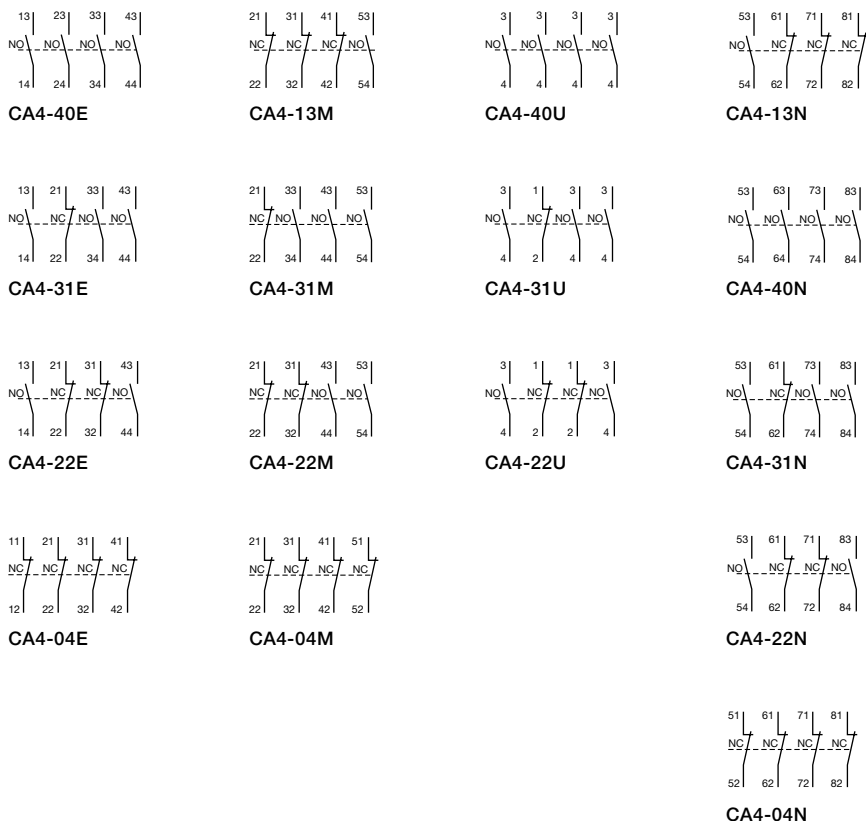



# Overload relays

## Table of contents

### Thermal overload relays, Class 10

TF42 (0.10 ... 38 A) for AF09 ... AF38 .....	3.2
TF65 (22 ... 67 A) for AF40 ... AF65 .....	3.3
TF96 (40 ... 96 A) for AF80, AF96 .....	3.4
TF140DU (66 ... 142 A) for AF116 ... AF146 .....	3.5
TA200DU (66 ... 200 A) for AF190, AF205 .....	3.6

### Electronic overload relays

EF19, EF45 (0.10 ... 45 A) for AF09 ... AF38 .....	3.7
EF65, EF96, EF154 (25 ... 150 A) for AF40 ... AF146 .....	3.8
EF205, EF370 (63 ... 380 A) for AF190 ... AF370 .....	3.9
E500DU, E800DU, E1250DU (150 ... 1250 A) for AF400 ... AF1650 .....	3.10 - 3.11

### Technical data

Thermal overload relays .....	3.12 - 3.26
Electronic overload relays .....	3.27 - 3.37

# TF42 thermal overload relays

0.10 ... 38.0 A

For direct coupling to AF09 ... AF38 3-pole contactors

## Description

The TF42 thermal overload relays are economic electromechanical protection devices for the main circuit. They offer reliable protection for motors in the event of overload or phase failure. The devices have trip class 10.

The thermal overload relays are three pole relays with bimetal tripping elements. The motor current flows through the bimetal tripping elements and heats them directly and indirectly. In case of an overload (over current), the bimetal elements bent as a result of the heating. This leads to a release of the relay and a change of the contacts switching position (95-96 / 97-98).

- Manual or automatic reset selectable
- Phase loss sensitive acc. to IEC/EN 60947-4-1
- TEST and STOP function – Trip indication on the front
- Temperature compensation
- Suitable for three- and single-phase applications

## Ordering details

Setting range	For contactors	Trip class	Catalog number	Global reference code	Weight (1 pce) kg
<b>A</b>					
0.10 ... 0.13	AF09... AF38	10	TF42-0.13	1SAZ721201R1005	0.130
0.13 ... 0.17	AF09... AF38	10	TF42-0.17	1SAZ721201R1008	0.130
0.17 ... 0.23	AF09... AF38	10	TF42-0.23	1SAZ721201R1009	0.130
0.23 ... 0.31	AF09... AF38	10	TF42-0.31	1SAZ721201R1013	0.130
0.31 ... 0.41	AF09... AF38	10	TF42-0.41	1SAZ721201R1014	0.130
0.41 ... 0.55	AF09... AF38	10	TF42-0.55	1SAZ721201R1017	0.130
0.55 ... 0.74	AF09... AF38	10	TF42-0.74	1SAZ721201R1021	0.130
0.74 ... 1.00	AF09... AF38	10	TF42-1.0	1SAZ721201R1023	0.130
1.00 ... 1.30	AF09... AF38	10	TF42-1.3	1SAZ721201R1025	0.130
1.30 ... 1.70	AF09... AF38	10	TF42-1.7	1SAZ721201R1028	0.130
1.70 ... 2.30	AF09... AF38	10	TF42-2.3	1SAZ721201R1031	0.130
2.30 ... 3.10	AF09... AF38	10	TF42-3.1	1SAZ721201R1033	0.130
3.10 ... 4.20	AF09... AF38	10	TF42-4.2	1SAZ721201R1035	0.130
4.20 ... 5.70	AF09... AF38	10	TF42-5.7	1SAZ721201R1038	0.130
5.70 ... 7.60	AF09... AF38	10	TF42-7.6	1SAZ721201R1040	0.130
7.60 ... 10.0	AF09... AF38	10	TF42-10	1SAZ721201R1043	0.130
10.0 ... 13.0	AF09... AF38	10	TF42-13	1SAZ721201R1045	0.130
13.0 ... 16.0	AF09... AF38	10	TF42-16	1SAZ721201R1047	0.130
16.0 ... 20.0	AF09... AF38	10	TF42-20	1SAZ721201R1049	0.145
20.0 ... 24.0	AF09... AF38	10	TF42-24	1SAZ721201R1051	0.145
24.0 ... 29.0	AF09... AF38	10	TF42-29	1SAZ721201R1052	0.145
29.0 ... 35.0	AF09... AF38	10	TF42-35	1SAZ721201R1053	0.145
35.0 ... 38.0/40.0	AF09... AF38	10	TF42-38	1SAZ721201R1055	0.145

## Ordering details accessories

For thermal overload relays	Description	Catalog number	Global reference code	Weight (1 pce) kg
<b>A</b>				
TF42	Single mounting kit	DB42	1SAZ701902R0001	0.087
TF42	Reset push button (1)	KPR-101L	1SFA616162R1014	0.027

## Main dimensions mm, inches

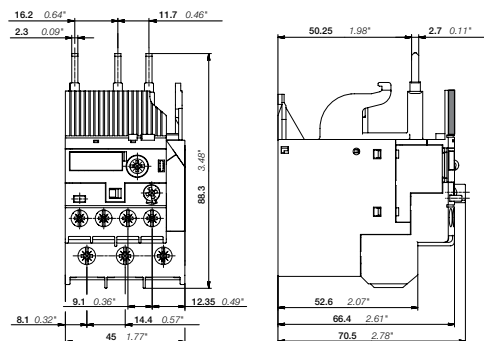

TF42

(1) Note: for more information see catalog 1SXU000023C0202 Rev. A.

# TF65 thermal overload relays

22.0 ... 67.0 A

For direct coupling to AF40... AF65 3-pole contactors



TF65

## Description

The TF65 thermal overload relays are economic electromechanical protection devices for the main circuit. They offer reliable protection for motors in the event of overload or phase failure. The devices have trip class 10.

The thermal overload relays are three pole relays with bimetal tripping elements. The motor current flows through the bimetal tripping elements and heats them directly and indirectly. In case of an overload (over current), the bimetal elements bent as a result of the heating. This leads to a release of the relay and a change of the contacts switching position (95-96 / 97-98).

Manual or automatic reset selectable

Phase loss sensitive acc. to IEC/EN 60947-4-1

TEST and STOP function – Trip indication on the front

Temperature compensation

Suitable for three- and single-phase applications

## Ordering details

Setting range	For contactors	Trip class	Catalog number	Global reference code	Weight (1 pce) kg
<b>A</b>					
22.0 ... 28.0	AF40 ... AF65	10	TF65-28	1SAZ811201R1001	0.456
25.0 ... 33.0	AF40 ... AF65	10	TF65-33	1SAZ811201R1002	0.456
30.0 ... 40.0	AF40 ... AF65	10	TF65-40	1SAZ811201R1003	0.456
36.0 ... 47.0	AF40 ... AF65	10	TF65-47	1SAZ811201R1004	0.456
44.0 ... 53.0	AF40 ... AF65	10	TF65-53	1SAZ811201R1005	0.456
50.0 ... 60.0	AF40 ... AF65	10	TF65-60	1SAZ811201R1006	0.466
57.0 ... 67.0	AF40 ... AF65	10	TF65-67	1SAZ811201R1007	0.466



KPR-101L

## Ordering details accessories

For thermal overload relays	Description	Catalog number	Global reference code	Weight (1 pce) kg
<b>A</b>				
TF65	Reset push button (1)	KPR-101L	1SFA616162R1014	0.027

(1) Note: for more information see catalog 1SXU000023C0202 Rev. A.

## Main dimensions mm, inches

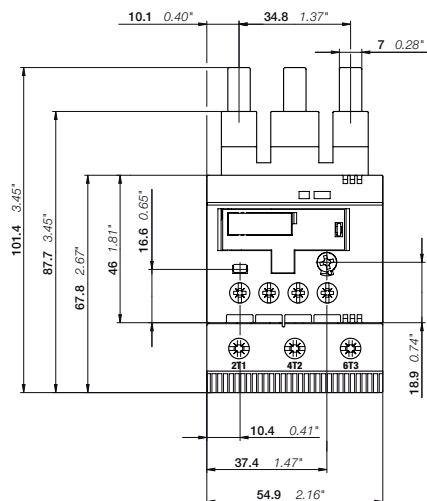

TF65

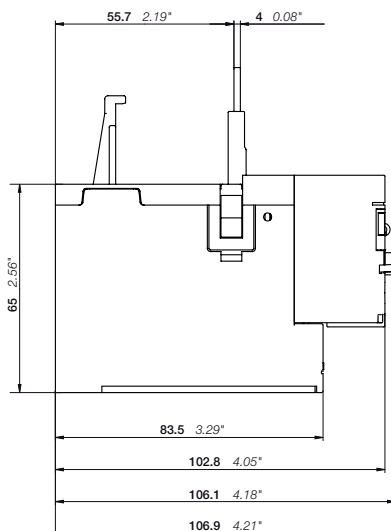

# TF96 thermal overload relays

40.0 ... 96.0 A

For direct coupling to AF80, AF96 3-pole contactors

3



TF96

## Description

The TF96 thermal overload relays are economic electromechanical protection devices for the main circuit. They offer reliable protection for motors in the event of overload or phase failure. The devices have trip class 10.

The thermal overload relays are three pole relays with bimetal tripping elements. The motor current flows through the bimetal tripping elements and heats them directly and indirectly. In case of an overload (over current), the bimetal elements bent as a result of the heating. This leads to a release of the relay and a change of the contacts switching position (95-96 / 97-98).

Manual or automatic reset selectable

Phase loss sensitive acc. to IEC/EN 60947-4-1

TEST and STOP function – Trip indication on the front

Temperature compensation

Suitable for three- and single-phase applications

## Ordering details

Setting range	For contactors	Trip class	Catalog number	Global reference code	Weight (1 pce) kg
<b>A</b>					
40.0 ... 51.0	AF80, AF96	10	TF96-51	1SAZ911201R1001	0.620
48.0 ... 60.0	AF80, AF96	10	TF96-60	1SAZ911201R1002	0.620
57.0 ... 68.0	AF80, AF96	10	TF96-68	1SAZ911201R1003	0.620
65.0 ... 78.0	AF80, AF96	10	TF96-78	1SAZ911201R1004	0.620
75.0 ... 87.0	AF80, AF96	10	TF96-87	1SAZ911201R1005	0.620
84.0 ... 96.0	AF80, AF96	10	TF96-96	1SAZ911201R1006	0.630



KPR-101L

## Ordering details accessories

For thermal overload relays	Description	Catalog number	Global reference code	Weight (1 pce) kg
<b>A</b>				
TF96	Reset push button (1)	KPR-101L	1SFA616162R1014	0.027

(1) Note: for more information see catalog 1SXU000023C0202 Rev. A.

## Main dimensions mm, inches

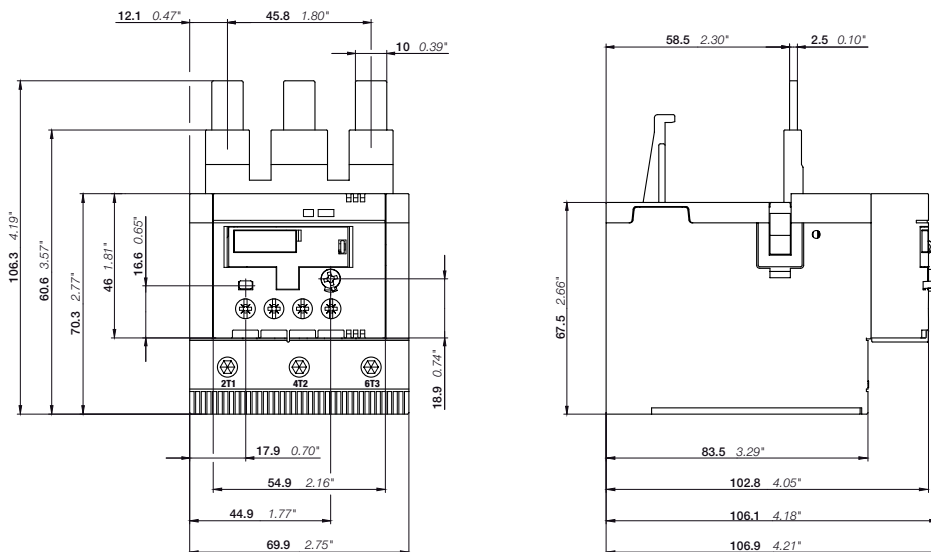

TF96

# TF140DU thermal overload relays

66 ... 142 A

For direct coupling to AF116 ... AF146 3-pole contactors



TF140DU



KPR-101L

## Description

The TF140DU thermal overload relays are economic electromechanical protection devices for the main circuit. They offer reliable protection for motors in the event of overload or phase failure. The devices have trip class 10A.

The thermal overload relays are three pole relays with bimetal tripping elements. The motor current flows through the bimetal tripping elements and heats them directly and indirectly. In case of an overload (over current), the bimetal elements bent as a result of the heating. This leads to a release of the relay and a change of the contacts switching position (95-96 / 97-98).

- Manual or automatic reset selectable
- Phase loss sensitive acc. to IEC/EN 60947-4-1
- TEST and STOP function - Trip indication on the front
- Temperature compensation
- Suitable for three- and single-phase applications

## Ordering details

Setting range	For contactors	Trip class	Catalog number	Global reference code	Weight (1 pce) kg
A					
66 ... 90	AF116 ... AF146	10A	TF140DU-90	1SAZ431201R1001	0.820
80 ... 110	AF116 ... AF146	10A	TF140DU-110	1SAZ431201R1002	0.820
100 ... 135	AF116 ... AF146	10A	TF140DU-135	1SAZ431201R1003	0.820
110 ... 142	AF116 ... AF146	10A	TF140DU-142	1SAZ431201R1004	0.820

## Ordering details accessories

For thermal overload relays	Description	Catalog number	Global reference code	Weight (1 pce) kg
A				
TF140DU	Reset push button (1)	KPR-101L	1SFA616162R1014	0.027

(1) Note: for more information see catalog 1SXU000023C0202 Rev. A.

## Main dimensions mm, inches

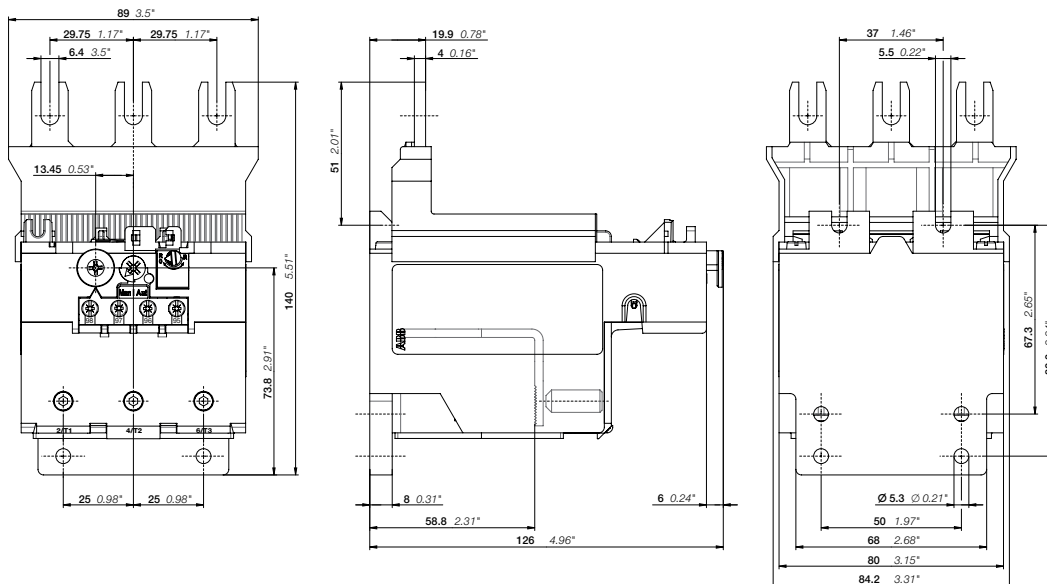

TF140DU

# TA200DU thermal overload relays

## 66 ... 200 A

### For direct coupling to AF190, AF205 3-pole contactors

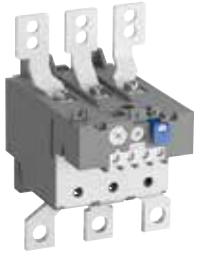

TA200DU-200



KPR-101L

### Description

The TA200DU thermal overload relays are economic electromechanical protection devices for the main circuit. They offer reliable protection for motors in the event of overload or phase failure. The devices have trip class 10A.

The thermal overload relays are three pole relays with bimetal tripping elements. The motor current flows through the bimetal tripping elements and heats them directly and indirectly. In case of an overload (over current), the bimetal elements bent as a result of the heating. This leads to a release of the relay and a change of the contacts switching position (95-96 / 97-98).

- Manual or automatic reset selectable
- Phase loss sensitive acc. to IEC/EN 60947-4-1
- TEST and STOP function – Trip indication on the front
- Temperature compensation
- Suitable for three- and single-phase applications

### Ordering details

Setting range	For contactors	Trip class	Catalog number	Global reference code	Weight (1 pce) kg
A					
66 ... 90	AF190, AF205	10A	TA200DU90	1SAZ421201R1001	0.755
80 ... 110	AF190, AF205	10A	TA200DU110	1SAZ421201R1002	0.760
100 ... 135	AF190, AF205	10A	TA200DU135	1SAZ421201R1003	0.760
110 ... 150	AF190, AF205	10A	TA200DU150	1SAZ421201R1004	0.760
130 ... 175	AF190, AF205	10A	TA200DU175	1SAZ421201R1005	0.770
150 ... 200	AF190, AF205	10A	TA200DU200	1SAZ421201R1006	0.785

### Ordering details accessories

For thermal overload relays	Description	Catalog number	Global reference code	Weight (1 pce) kg
A				
TA200DU (1)	Terminal shroud	LT200A185	1SAZ401901R1001	0.090
TA200DU	Single mounting kit	DB200	1SAZ401110R0001	0.225
TA200DU	Mechanical lug kit, 1 conductor/phase	EHTK210	(2)	0.118
TA200DU	Reset push button (3)	KPR-101L	1SFA616162R1014	0.027

(1) Load side only.

(2) North American applications only.

(3) Note: for more information see catalog 1SXU000023C0202 Rev. A.

### Main dimensions mm, inches

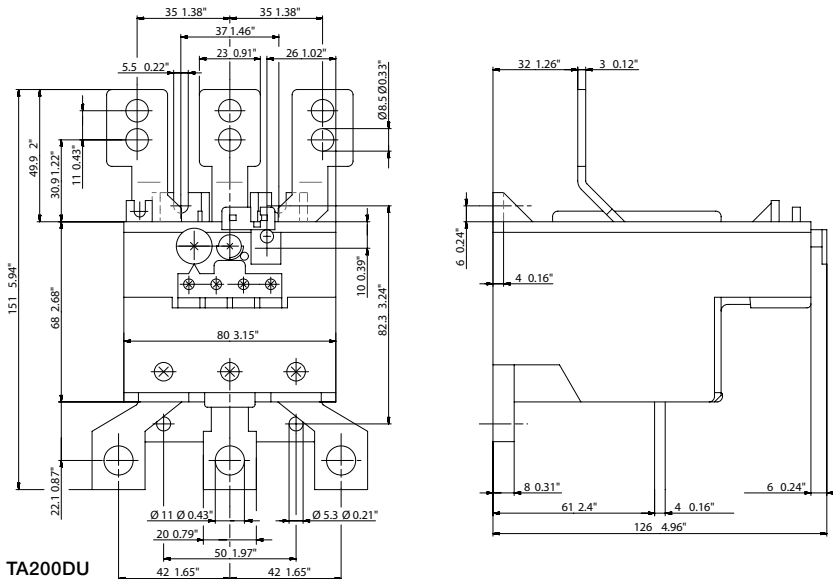

# EF19, EF45 electronic overload relays

## 0.10 to 45.0 A

### For direct coupling to AF09 ... AF38 3-pole contactors



EF19-18.9



EF45-30

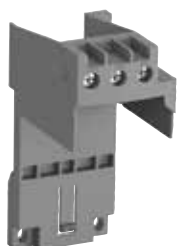

DB19EF



KPR-101L

#### Description

The EF19 and EF45 are self-supplied electronic overload relays, which means no extra external supply is needed. It offers reliable protection for motors in the event of overload or phase failure. Easy to use like a thermal overload relay and compatible with standard motor applications, the electronic overload relay is convincing, above all, due to its wide setting range, high accuracy, high operational temperature range and the possibility to select a trip class (10E, 20E, 30E). Further features are the temperature compensation, trip contact (N.C.), signal contact (N.O.), automatic or manual reset selectable, trip-free mechanism, STOP and TEST function and a trip indication. The overload relays are connected directly to the contactors.

#### Ordering details

Setting range	For contactors	Trip class	Catalog number	Global reference code	Weight (1 pce) kg
<b>A</b>					
<b>EF19 electronic overload relays</b>					
0.10 ... 0.32	AF09 ... AF38	10E, 20E, 30E	EF19-0.32	1SAX121001R1101	0.158
0.30 ... 1.00	AF09 ... AF38	10E, 20E, 30E	EF19-1.0	1SAX121001R1102	0.158
0.80 ... 2.70	AF09 ... AF38	10E, 20E, 30E	EF19-2.7	1SAX121001R1103	0.158
1.90 ... 6.30	AF09 ... AF38	10E, 20E, 30E	EF19-6.3	1SAX121001R1104	0.158
5.70 ... 18.9	AF09 ... AF38	10E, 20E, 30E	EF19-18.9	1SAX121001R1105	0.158
<b>EF45 electronic overload relays</b>					
9.00 ... 30.0	AF09 ... AF38	10E, 20E, 30E	EF45-30	1SAX221001R1101	0.362
15.0 ... 45.0	AF09 ... AF38	10E, 20E, 30E	EF45-45	1SAX221001R1102	0.362

#### Ordering details accessories

For thermal overload relays	Description	Catalog number	Global reference code	Weight (1 pce) kg
<b>A</b>				
EF19	Single mounting kit	DB19EF	1SAX101910R1001	0.042
EF19, EF45	Reset push button (1)	KPR-101L	1SFA616162R1014	0.019

(1) Note: for more information see catalog 1SXU000023C0202 Rev. A.

#### Main dimensions mm, inches

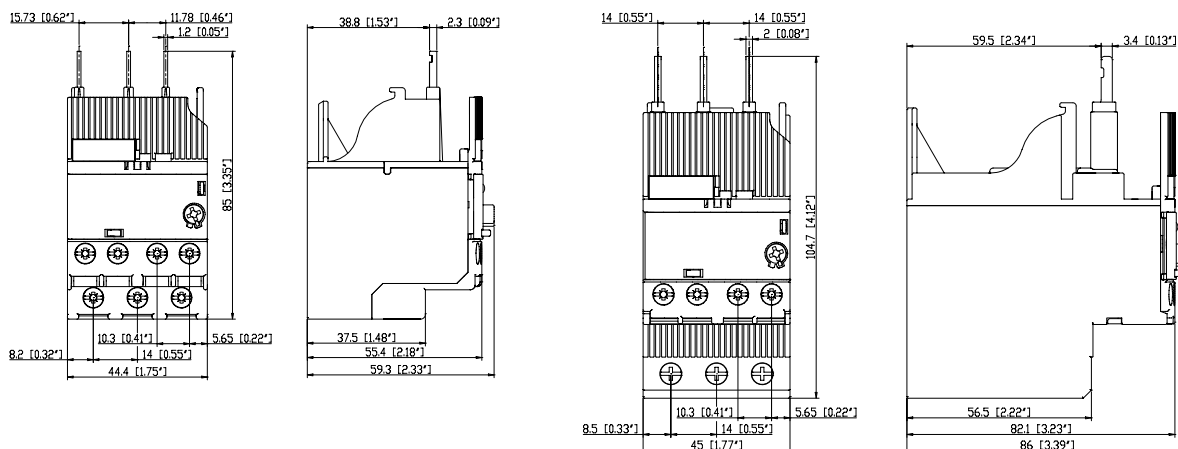

# EF65, EF96, EF146 electronic overload relays

## 25 to 150 A

### For direct coupling to AF40 ... AF146 3-pole contactors

3



EF65-70



EF96-100



EF146-150



KPR-101L

#### Description

The EF65, EF96 and EF146 are self-supplied electronic overload relays, which means no extra external supply is needed. It offers reliable protection for motors in the event of overload or phase failure. Easy to use like a thermal overload relay and compatible with standard motor applications, the electronic overload relay is convincing, above all, due to its wide setting range, high accuracy, high operational temperature range and the possibility to select a trip class (10E, 20E, 30E). Further features are the temperature compensation, trip contact (N.C.), signal contact (N.O.), automatic or manual reset selectable, trip-free mechanism, STOP and TEST function and a trip indication. The overload relays are connected directly to the contactors.

#### Ordering details

Setting range	For contactors	Trip class	Catalog number	Global reference code	Weight (1 pce) kg
A					
25 ... 70	AF40 ... AF65	10E, 20E, 30E	EF65-70	1SAX331001R1101	0.790
36 ... 100	AF80, AF96	10E, 20E, 30E	EF96-100	1SAX341001R1101	0.780
54 ... 150	AF116 ... AF146	10E, 20E, 30E	EF146-150	1SAX351001R1101	0.890

#### Ordering details accessories

For thermal overload relays	Description	Catalog number	Global reference code	Weight (1 pce) kg
A				
EF65, EF96, EF146	Reset push button (1)	KPR-101L	1SFA616162R1014	0.027

(1) Note: for more information see catalog 1SXU00023C0202 Rev. A.

#### Main dimensions mm, inches

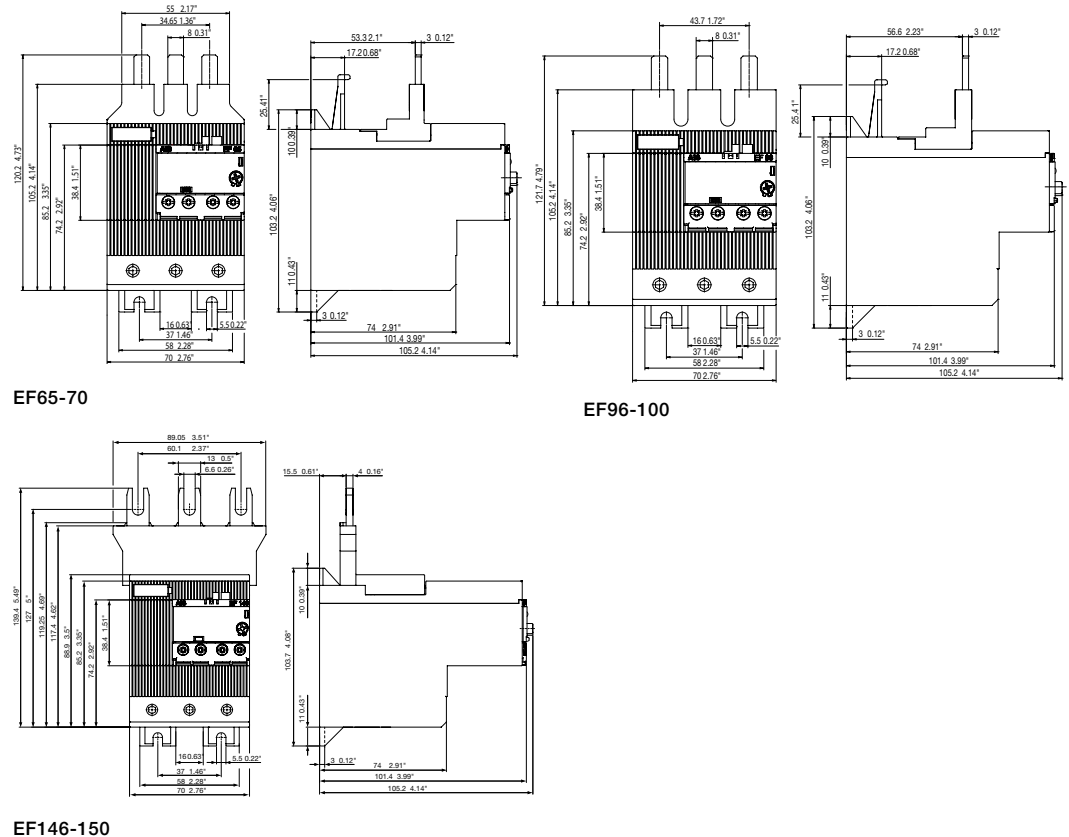



# EF205, EF370 electronic overload relays

## 63 to 380 A

### For direct coupling to AF190 ... AF370 3-pole contactors



EF205-210



EF370-380



KPR-101L

#### Description

The EF205 and EF370 are self-supplied electronic overload relays, which means no extra external supply is needed. It offers reliable protection for motors in the event of overload or phase failure. Easy to use like a thermal overload relay and compatible with standard motor applications, the electronic overload relay is convincing, above all, due to its wide setting range, high accuracy, high operational temperature range and the possibility to select a trip class (10E, 20E, 30E). Further features are the temperature compensation, trip contact (N.C.), signal contact (N.O.), automatic or manual reset selectable, trip-free mechanism, STOP and TEST function and a trip indication. The overload relays are connected directly to the contactors.

#### Ordering details

Setting range	For contactors	Trip class	Catalog number	Global reference code	Weight (1 pce) kg
<b>A</b>					
63 ... 210	AF190, AF205	10E, 20E, 30E	EF205-210	1SAX531001R1101	1.210
115 ... 380	AF265 ... AF370	10E, 20E, 30E	EF370-380	1SAX611001R1101	1.430

#### Ordering details accessories

For thermal overload relays	Description	Catalog number	Global reference code	Weight (1 pce) kg
<b>A</b>				
EF205, EF370	Reset push button (1)	KPR-101L	1SFA616162R1014	0.027
EF205	Lug kit, 1-wire, 4 AWG... 300 MCM	ATK185	(2)	0.164
EF370	Lug kit, 1-wire, 4 AWG... 400 MCM	ATK300	(2)	0.166
EF370	Lug kit, 2-wire, 4 AWG... 500 MCM	ATK300/2	(2)	0.445
EF205	LT200E Terminal shroud for EF205	LT200E	1SAX501904R0001	0.145
EF370	LT320E Terminal shroud for EF370	LT320E	1SAX601904R0001	0.160

(1) Note: for more information see catalog 1SXU000023C0202 Rev. A.  
 (2) North American applications only.

#### Main dimensions mm, inches

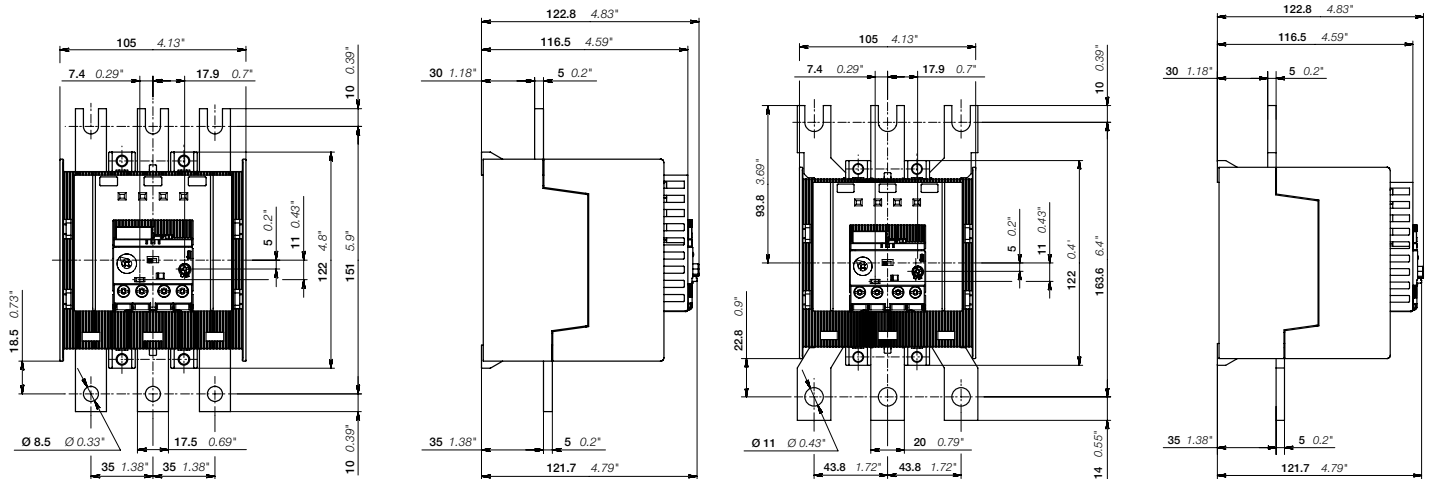

EF205-210

EF370-380

# E500DU, E800DU, E1250DU electronic overload relays

## 150 to 1250 A

### For use with AF400 ... AF1650 3-pole contactors



E500DU-500

3



E800DU-800



E1250DU-1250



KPR-101L

#### Description

The E500DU up to E1250DU are self-supplied electronic overload relays, which means no extra external supply is needed. It offers reliable protection for motors in the event of overload or phase failure. Easy to use like a thermal overload relay and compatible with standard motor applications, the electronic overload relay is convincing, above all, due to its wide setting range, high accuracy, high operational temperature range and the possibility to select a trip class (10E, 20E, 30E). Further features are the temperature compensation, trip contact (N.C.), signal contact (N.O.), automatic or manual reset selectable, trip-free mechanism, STOP and TEST function and a trip indication. Busbar kits are available as accessory for contactor mounting.

#### Ordering details

Setting range	For contactors	Trip class	Catalog number	Global reference code	Weight (1 pce) kg
<b>A</b>					
<b>E500DU electronic overload relay</b>					
150 ... 500	AF400, AF460	10E, 20E, 30E	E500DU-500	1SAX711001R1101	1.170
<b>E800DU electronic overload relay</b>					
250 ... 800	AF580, AF750	10E, 20E, 30E	E800DU-800	1SAX811001R1101	3.905
<b>E1250DU electronic overload relay</b>					
375 ... 1250	AF1350, AF1650	10E, 20E, 30E	E1250DU-1250	1SFA739001R1000	12.181

#### Ordering details accessories

For electronic overload relays	Description	Catalog number	Global reference code	Weight (1 pce) kg
E500DU	LT500E Terminal shroud for E500DU	LT500E	1SAX701904R0001	0.360
E800DU	LT320E Terminal shroud for E320DU	LT800-E	1SAX601904R0001	0.105
E500DU, E800DU	Reset push button (1)	KPR-101L	1SFA616162R1014	0.027
E500DU	Lug kit, 3-wire, 2/0 AWG... 500 MCM, w/hardware	ATK580/2HK	(2)	0.880
E800DU	Lug kit, 3-wire, 2/0 AWG... 500 MCM, w/hardware	ATK750/3HK	(2)	1.897
E1250DU	Lug kit, 4-wire, 4/0 AWG... 500 MCM	ATK1350/4	(2)	1.883
E500DU	Panel mount adaptors, AF400, AF460 non-reversing	DT500/AF460S	1SAX701902R1011	0.650
E500DU	Panel mount adaptors, AF400, AF460 reversing	DT500/AF460L	1SAX701902R1001	0.755
E800DU	Panel mount adaptors, AF580, AF750 non-reversing	DT800/AF750S	1SAX801902R1011	1.490
E800DU	Panel mount adaptors, AF580, AF750 reversing	DT800/AF750L	1SAX801902R1001	1.490

(1) Note: for more information see catalog 1SXU000023C0202 Rev. A.

(2) North American applications only.

Main dimensions mm, inches

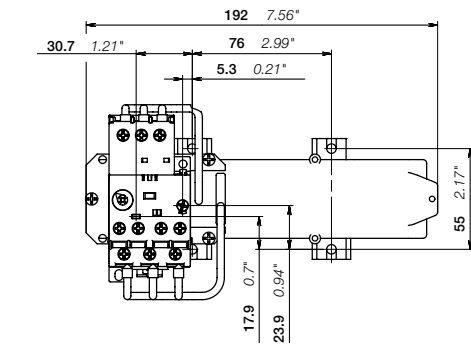
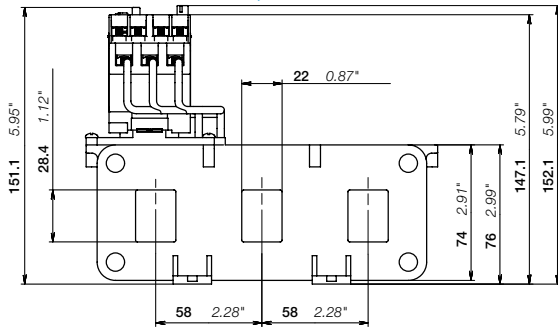

E500DU

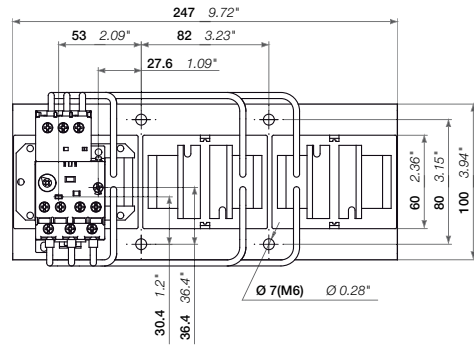
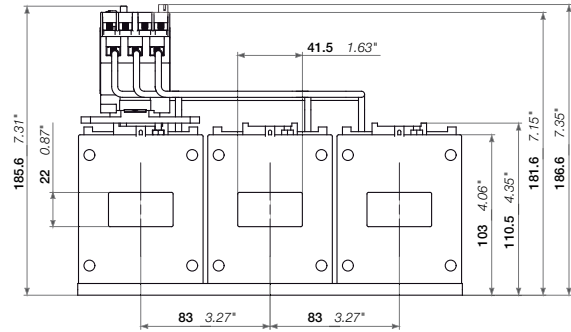

E800DU

# TF42 thermal overload relays

## Technical data

### Main circuit – Utilization characteristics according to IEC/EN

Type	TF42
Standards	IEC/EN 60947-4-1, IEC/EN 60947-5-1, IEC/EN 60947-1
Rated operational voltage $U_e$	690 V AC
Rated frequency	50/60 Hz
Trip class	10
Number of poles	3
Duty time	100 %
Operating frequency without early tripping	Up to 15 operations/h, see "Technical diagram – Intermittent periodic duty"
Rated impulse withstand voltage $U_{imp}$	6 kV
Rated insulation voltage $U_i$	690 V AC

### Auxiliary circuit according to IEC/EN

Type	TF42
Rated operational voltage $U_e$	600 V
Conventional free air thermal current $I_{th}$	N.C., 95-96 6 A N.O., 97-98 4 A
Rated frequency	DC, 50/60 Hz
Number of poles	1 N.O. + 1 N.C.
$I_e$ / Rated operational current AC-15 acc. to IEC/EN 60947-5-1 for utilization category	
110-120 V	N.C., 95-96 3.00 A N.O., 97-98 0.75 A
220-230-240 V	N.C., 95-96 3.00 A N.O., 97-98 0.75 A
440 V	N.C., 95-96 0.75 A N.O., 97-98 0.75 A
480-500 V	N.C., 95-96 0.75 A N.O., 97-98 0.75 A
$I_e$ / Rated operational current DC-13 acc. to IEC/EN 60947-5-1 for utilization category	
24 V	N.C., 95-96 1.25 A N.O., 97-98 1.25 A
110-120-125 V	N.C., 95-96 0.55 A N.O., 97-98 0.55 A
250 V	N.C., 95-96 0.27 A N.O., 97-98 0.27 A
Minimum switching capacity	17 V / 3 mA
Short-circuit protective device	N.C., 95-96 6 A, Fuse type gG N.O., 97-98 4 A, Fuse type gG
Rated impulse withstand voltage $U_{imp}$	6 kV
Rated insulation voltage $U_i$	690 V

### Technical diagram – Intermittent periodic duty

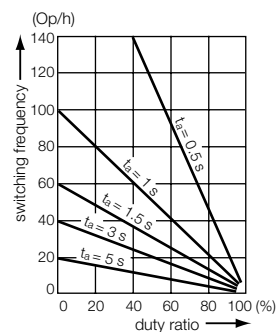

$t_a$ : Motor starting time

# TF42 thermal overload relays

## Technical data

### Main circuit – Utilization characteristics according to UL/CSA

Type	TF42
Standards	UL 60947-1 / 60947-4-1A and CSA 60947-1 / 60947-4-1A
Maximum operational voltage	600 V AC
Trip rating	125 % of FLA
Full load amps (FLA)	See table "Full load amps and short-circuit protective device"
Short-circuit rating RMS symmetrical	See table "Full load amps and short-circuit protective device"
Short-circuit protective device	See table "Full load amps and short-circuit protective device"

### Auxiliary circuit according to UL/CSA

Type	TF42
Contact rating	N.C., 95-96 B600, Q300 N.O., 97-98 D300, Q300
Conventional thermal current	N.C., 95-96 5 A N.O., 97-98 2.5 A

### Full load amps and short-circuit protective device

Type	Full load amps (FLA)	Short-circuit protective device			
		480 / 600 V AC		480 / 600 V AC	
		Short circuit rating RMS symmetrical	Fuse type	Short circuit rating RMS symmetrical	Fuse type
TF42-0.13	0.13 A	18 kA	1 A, K5	100 kA	30 A, Class J
TF42-0.17	0.17 A	18 kA	1 A, K5	100 kA	30 A, Class J
TF42-0.23	0.23 A	18 kA	1 A, K5	100 kA	30 A, Class J
TF42-0.31	0.31 A	18 kA	3 A, K5	100 kA	30 A, Class J
TF42-0.41	0.41 A	18 kA	3 A, K5	100 kA	30 A, Class J
TF42-0.55	0.55 A	18 kA	3 A, K5	100 kA	30 A, Class J
TF42-0.74	0.74 A	18 kA	3 A, K5	100 kA	30 A, Class J
TF42-1.0	1.00 A	18 kA	6 A, K5	100 kA	30 A, Class J
TF42-1.3	1.30 A	18 kA	6 A, K5	100 kA	30 A, Class J
TF42-1.7	1.70 A	18 kA	6 A, K5	100 kA	30 A, Class J
TF42-2.3	2.30 A	18 kA	10 A, K5	100 kA	30 A, Class J
TF42-3.1	3.10 A	18 kA	10 A, K5	100 kA	30 A, Class J
TF42-4.2	4.20 A	18 kA	15 A, K5	100 kA	30 A, Class J
TF42-5.7	5.70 A	18 kA	20 A, K5	100 kA	30 A, Class J
TF42-7.6	7.60 A	18 kA	25 A, K5	100 kA	30 A, Class J
TF42-10	10.0 A	18 kA	35 A, K5	100 kA	45 A, Class J
TF42-13	13.0 A	18 kA	40 A, K5	100 kA	45 A, Class J
TF42-16	16.0 A	18 kA	60 A, K5	100 kA	45 A, Class J
TF42-20	20.0 A	18 kA	80 A, K5	100 kA	60 A, Class J
TF42-24	24.0 A	18 kA	80 A, K5	100 kA	60 A, Class J
TF42-29	29.0 A	18 kA	100 A, K5	100 kA	100 A, Class J
TF42-35	35.0 A	18 kA	150 A, K5	100 kA	175 A, Class J
TF42-38	38.0 A	18 kA	150 A, K5	100 kA	175 A, Class J

# TF42 thermal overload relays



## Technical data

### General technical data

Type	TF42	
Pollution degree	3	
Phase loss sensitive	Yes	
Ambient air temperature		
Operation	Open - compensated	-25 ... +60 °C
	Open	-25 ... +60 °C
Storage		-50 ... +80 °C
Ambient air temperature compensation	Acc. to IEC/EN60947-4-1	
Maximum operating altitude permissible	2000 m	
Resistance to shock acc. to IEC 60068-2-27	25g / 11 ms	
Resistance to vibrations acc. to IEC 60068-2-6	3g / 3 ... 150 Hz	
Mounting position	Position 1-5	
Mounting	Mount on the contactor and tighten the screws of the main circuit terminals or with single mounting kit on DIN rail (35 mm)	
Degree of protection	Housing	IP20
	Main circuit terminals	IP10





### Electrical connection

#### Main circuit

Type	TF42 (TF42-0.13 ... TF42-16)		TF42 (TF42-20 ... TF42-38)
Connecting capacity			
 Rigid	1 x or 2 x	0.75 ... 4 mm <sup>2</sup>	1.5 ... 2.5 mm <sup>2</sup> or 2.5 ... 10 mm <sup>2</sup> <sup>1)</sup>
 Flexible with insulated ferrule	1 x or 2 x	0.75 ... 4 mm <sup>2</sup>	2.5 ... 4 mm <sup>2</sup> or 4 ... 6 mm <sup>2</sup>
Stranded acc. to UL/CSA	1 x or 2 x	AWG 18-10	AWG 14-6
Flexible acc. to UL/CSA	1 x or 2 x	AWG 18-10	AWG 14-6
Stripping length	12 mm		
Tightening torques	1.5 - 2.5 Nm / 13 ... 22 lb.in		2.5 - 2.7 Nm / 22 lb.in
Connection screw	M4 (Pozidriv 2)		

<sup>1)</sup> Only connect two different "conductor/wire" cross-sections, if they are within the indicated ranges

#### Auxiliary circuit

Type	TF42	
Connecting capacity		
 Rigid	1 x or 2 x	0.75 ... 4 mm <sup>2</sup>
 Flexible with ferrule	1 x or 2 x	0.75 ... 2.5 mm <sup>2</sup>
 Flexible with insulated ferrule	1 x	0.75 ... 2.5 mm <sup>2</sup>
	2 x	0.75 ... 1.5 mm <sup>2</sup>
 Flexible	1 x or 2 x	0.75 ... 1 mm <sup>2</sup> or 1 ... 2.5 mm <sup>2</sup>
Stranded acc. to UL/CSA	1 x or 2 x	AWG 18-12
Flexible acc. to UL/CSA	1 x or 2 x	AWG 18-12
Stripping length	9 mm	
Tightening torques	1.1 ... 1.5 Nm / 9 ... 13 lb.in	
Connection screw	M3 (Pozidriv 2)	

# TF65 thermal overload relays

## Technical data

### Main circuit – Utilization characteristics according to IEC/EN

Type	TF65
Standards	IEC/EN 60947-1, IEC/EN 60947-4-1, IEC/EN 60947-5-1
Rated operational voltage $U_e$	690 V AC
Rated frequency	50/60 Hz
Trip class	10
Number of poles	3
Duty time	100 %
Operating frequency without early tripping	Up to 15 operations/h, see "Technical diagram – Intermittent periodic duty"
Rated impulse withstand voltage $U_{imp}$	8 kV
Rated insulation voltage $U_i$	690 V

### Auxiliary circuit according to IEC/EN

Type	TF65
Rated operational voltage $U_e$	600 V
Conventional free air thermal current $I_{th}$	N.C., 95-96 6 A N.O., 97-98 4 A
Rated frequency	DC, 50/60 Hz
Number of poles	1 N.O. + 1 N.C.
$I_e$ / Rated operational current AC-15 acc. to IEC/EN 60947-5-1 for utilization category	
110-120 V	N.C., 95-96 3.00 A N.O., 97-98 0.75 A
220-230-240 V	N.C., 95-96 3.00 A N.O., 97-98 0.75 A
440 V	N.C., 95-96 0.75 A N.O., 97-98 0.75 A
480-500 V	N.C., 95-96 0.75 A N.O., 97-98 0.75 A
$I_e$ / Rated operational current DC-13 acc. to IEC/EN 60947-5-1 for utilization category	
24 V	N.C., 95-96 1.25 A N.O., 97-98 1.25 A
110-120-125 V	N.C., 95-96 0.55 A N.O., 97-98 0.55 A
250 V	N.C., 95-96 0.27 A N.O., 97-98 0.27 A
Minimum switching capacity	17 V / 3 mA
Short-circuit protective device	N.C., 95-96 6 A, gG Type Fuses N.O., 97-98 4 A, gG Type Fuses
Rated impulse withstand voltage $U_{imp}$	6 kV
Rated insulation voltage $U_i$	690 V

### Technical diagram – Intermittent periodic duty

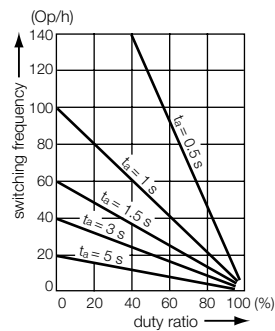

$t_s$ : Motor starting time

# TF65 thermal overload relays

## Technical data

### Main circuit – Utilization characteristics according to UL/CSA

Type	TF65
Standards	UL 60947-1 / 60947-4-1A and CSA 60947-1 / 60947-4-1A
Maximum operational voltage	600 V AC
Trip rating	125 % of FLA
Full load amps (FLA)	See table "Full load amps and short-circuit protective device"
Short-circuit rating RMS symmetrical	See table "Full load amps and short-circuit protective device"
Short-circuit protective device	See table "Full load amps and short-circuit protective device"

### 3 Auxiliary circuit according to UL/CSA

Type	TF65	
Contact rating	N.C., 95-96	B600, Q600
	N.O., 97-98	D300, Q600
Conventional thermal current	N.C., 95-96	6 A
	N.O., 97-98	4 A

### Full load amps and short-circuit protective device

Type	Full load amps (FLA)	480 / 600 V AC		480 / 600 V AC	
		Short circuit rating RMS symmetrical	Fuse type	Short circuit rating RMS symmetrical	Fuse type
TF65-28	28 A	5 kA	100 A, K5 / RK5	18 kA	110 A, Class J
TF65-33	33 A	5 kA	100 A, K5 / RK5	18 kA	110 A, Class J
TF65-40	40 A	5 kA	100 A, K5 / RK5	18 kA	110 A, Class J
TF65-47	47 A	5 kA	125 A, K5 / RK5	18 kA	125 A, Class J
TF65-53	53 A	10 kA	125 A, K5 / RK5	18 kA	125 A, Class J
TF65-60	60 A	10 kA	150 A, K5 / RK5	18 kA	150 A, Class J
TF65-67	67 A	10 kA	150 A, K5 / RK5	18 kA	150 A, Class J



# TF65 thermal overload relays





## Technical data

### General technical data

Type		TF65
Pollution degree		3
Phase loss sensitive		Yes
Ambient air temperature		
Operation	Open - compensated	-25 ... +60 °C
	Open	-25 ... +60 °C
Storage		-50 ... +80 °C
Ambient air temperature compensation		Acc. to IEC/EN 60947-4-1
Maximum operating altitude permissible		2000 m
Resistance to shock acc. to IEC 60068-2-27		25g / 11 ms
Resistance to vibrations acc. to IEC 60068-2-6		5g / 3 ... 150 Hz
Mounting position		Position 1
Mounting		Mount on the contactor and tighten the screws of the main circuit terminals or with single mounting kit on DIN rail (35 mm)
Degree of protection	Housing	IP20
	Main circuit terminals	IP10





### Electrical connection

#### Main circuit

Type			TF65
Connecting capacity			
 Rigid	1 x or 2 x		2.5 ... 16 mm <sup>2</sup>
	1 x		2.5 ... 35 mm <sup>2</sup>
 Flexible with ferrule	1 x or 2 x		2.5 ... 10 mm <sup>2</sup>
	1 x		2.5 ... 35 mm <sup>2</sup>
 Flexible with insulated ferrule	1 x or 2 x		2.5 ... 4 mm <sup>2</sup>
	1 x		2.5 ... 35 mm <sup>2</sup>
 Flexible	1 x or 2 x		2.5 ... 16 mm <sup>2</sup>
	1 x		2.5 ... 35 mm <sup>2</sup>
	Stranded acc. to UL/CSA	1 x	AWG 12 ... 2
		2 x	AWG 12 ... 6
	Flexible acc. to UL/CSA	1 x	AWG 12 ... 2
		2 x	AWG 12 ... 6
Stripping length			17 mm
Tightening torques			4.0 - 4.5 Nm / 35 ... 40 lb.in
Connection screw			M6 (Pozidriv 2)

<sup>1)</sup> Only connect two different "conductor/wire" cross-sections, if they are within the indicated ranges

#### Auxiliary circuit

Type			TF65
Connecting capacity			
 Rigid	1 x or 2 x		0.75 ... 4 mm <sup>2</sup>
 Flexible with ferrule	1 x or 2 x		0.75 ... 4 mm <sup>2</sup>
 Flexible with insulated ferrule	1 x		0.75 ... 2.5 mm <sup>2</sup>
	2 x		0.75 ... 1.5 mm <sup>2</sup>
 Flexible	1 x or 2 x		0.75 ... 1 mm <sup>2</sup> or 1 ... 2.5 mm <sup>2</sup>
	Stranded acc. to UL/CSA	1 x or 2 x	AWG 18 ... 12
	Flexible acc. to UL/CSA	1 x or 2 x	AWG 18 ... 12
Stripping length			9 mm
Tightening torques			1.1 ... 1.5 Nm / 9 ... 13 lb.in
Connection screw			M3 (Pozidriv 2)

# TF96 thermal overload relays

## Technical data

### Main circuit – Utilization characteristics according to IEC/EN

Type	TF96
Standards	IEC/EN 60947-1, IEC/EN 60947-4-1, IEC/EN 60947-5-1
Rated operational voltage $U_e$	690 V AC
Rated frequency	50/60 Hz
Trip class	10
Number of poles	3
Duty time	100 %
Operating frequency without early tripping	Up to 15 operations/h, see "Technical diagram – Intermittent periodic duty"
Rated impulse withstand voltage $U_{imp}$	8 kV
Rated insulation voltage $U_i$	690 V

### Auxiliary circuit according to IEC/EN

Type	TF96
Rated operational voltage $U_e$	600 V
Conventional free air thermal current $I_{th}$	N.C., 95-96 6 A N.O., 97-98 4 A
Rated frequency	DC, 50/60 Hz
Number of poles	1 N.O. + 1 N.C.
$I_e$ / Rated operational current AC-15 acc. to IEC/EN 60947-5-1 for utilization category	
110-120 V	N.C., 95-96 3.00 A N.O., 97-98 0.75 A
220-230-240 V	N.C., 95-96 3.00 A N.O., 97-98 0.75 A
440 V	N.C., 95-96 0.75 A N.O., 97-98 0.75 A
480-500 V	N.C., 95-96 0.75 A N.O., 97-98 0.75 A
$I_e$ / Rated operational current DC-13 acc. to IEC/EN 60947-5-1 for utilization category	
24 V	N.C., 95-96 1.25 A N.O., 97-98 1.25 A
110-120-125 V	N.C., 95-96 0.55 A N.O., 97-98 0.55 A
250 V	N.C., 95-96 0.27 A N.O., 97-98 0.27 A
Minimum switching capacity	17 V / 3 mA
Short-circuit protective device	N.C., 95-96 6 A, Fuse type gG N.O., 97-98 4 A, Fuse type gG
Rated impulse withstand voltage $U_{imp}$	6 kV
Rated insulation voltage $U_i$	690 V

### Technical diagram – Intermittent periodic duty

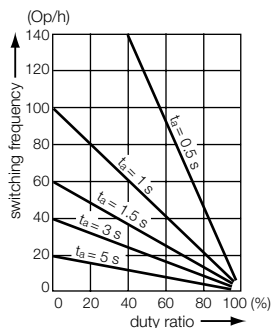

$t_s$ : Motor starting time

# TF96 thermal overload relays

## Technical data

### Main circuit – Utilization characteristics according to UL/CSA

Type	TF96
Standards	UL 60947-1 / 60947-4-1A and CSA 60947-1 / 60947-4-1A
Maximum operational voltage	600 V AC
Trip rating	125 % of FLA
Full load amps (FLA)	See table "Full load amps and short-circuit protective device"
Short-circuit rating RMS symmetrical	See table "Full load amps and short-circuit protective device"
Short-circuit protective device	See table "Full load amps and short-circuit protective device"

### Auxiliary circuit according to UL/CSA

Type	TF96	
Contact rating	N.C., 95-96	B600, Q600
	N.O., 97-98	D300, Q600
Conventional thermal current	N.C., 95-96	6 A
	N.O., 97-98	4 A

### Full load amps and short-circuit protective device

Type	Full load amps (FLA)	Short-circuit protective device			
		480 / 600 V AC		480 / 600 V AC	
		Short circuit rating RMS symmetrical	Fuse type	Short circuit rating RMS symmetrical	Fuse type
TF96-51	51 A	5 kA	150 A, K5 / RK5	18 kA	125 A, Class J
TF96-60	60 A	10 kA	150 A, K5 / RK5	18 kA	150 A, Class J
TF96-68	68 A	10 kA	150 A, K5 / RK5	18 kA	150 A, Class J
TF96-78	78 A	10 kA	175 A, K5 / RK5	18 kA	175 A, Class J
TF96-87	87 A	10 kA	200 A, K5 / RK5	18 kA	200 A, Class J
TF96-96	96 A	10 kA	250 A, K5 / RK5	18 kA	200 A, Class J

# TF96 thermal overload relays





## Technical data

### General technical data

Type		TF96
Pollution degree		3
Phase loss sensitive		Yes
Ambient air temperature		
Operation	Open - compensated	-25 ... +60 °C
	Open	-25 ... +60 °C
Storage		-50 ... +80 °C
Ambient air temperature compensation		Acc. to IEC/EN60947-4-1
Maximum operating altitude permissible		2000 m
Resistance to shock acc. to IEC 60068-2-27		25g / 11 ms
Resistance to vibrations acc. to IEC 60068-2-6		5g / 3 ... 150 Hz
Mounting position		Position 1
Mounting		Mount on the contactor and tighten the screws of the main circuit terminals or with single mounting kit on DIN rail (35 mm)
Degree of protection	Housing	IP20
	Main circuit terminals	IP10





### Electrical connection

#### Main circuit

Type		TF96
Connecting capacity		
 Rigid	1 x or 2 x	6 ... 35 mm <sup>2</sup>
	1 x	6 ... 50 mm <sup>2</sup>
 Flexible with ferrule	1 x or 2 x	6 ... 35 mm <sup>2</sup>
	1 x	6 ... 50 mm <sup>2</sup>
 Flexible with insulated ferrule	1 x or 2 x	6 ... 16 mm <sup>2</sup>
	1 x	6 ... 50 mm <sup>2</sup>
 Flexible	1 x or 2 x	6 ... 35 mm <sup>2</sup>
	1 x	6 ... 50 mm <sup>2</sup>
	Stranded acc. to UL/CSA	1 x
		2 x
	Flexible acc. to UL/CSA	1 x
		2 x
Stripping length		22 mm
Tightening torques		6.5 - 9 Nm / 57 ... 80 lb.in
Connection screw		M8 (Hexagon)

<sup>1)</sup> Only connect two different "conductor/wire" cross-sections, if they are within the indicated ranges

#### Auxiliary circuit

Type		TF96
Connecting capacity		
 Rigid	1 x or 2 x	0.75 ... 4 mm <sup>2</sup>
 Flexible with ferrule	1 x or 2 x	0.75 ... 4 mm <sup>2</sup>
 Flexible with insulated ferrule	1 x	0.75 ... 2.5 mm <sup>2</sup>
	2 x	0.75 ... 1.5 mm <sup>2</sup>
 Flexible	1 x or 2 x	0.75 ... 1 mm <sup>2</sup> or 1 ... 2.5 mm <sup>2</sup>
	Stranded acc. to UL/CSA	1 x or 2 x
		1 x or 2 x
	Flexible acc. to UL/CSA	1 x or 2 x
Stripping length		9 mm
Tightening torques		1.1 ... 1.5 Nm / 9 ... 13 lb.in
Connection screw		M3 (Pozi driv 2)

# TF140DU thermal overload relays

## Technical data

### Main circuit – Utilization characteristics according to IEC/EN

Type	TF140DU
Standards	IEC/EN 60947-1, IEC/EN 60947-4-1, IEC/EN 60947-5-1
Rated operational voltage $U_e$	690 V AC
Rated frequency	DC, 50/60 Hz
Frequency range	0 ... 400 Hz
Trip class	10A
Number of poles	3
Duty time	100 %
Operating frequency without early tripping	Up to 15 operations/h, see "Technical diagram – Intermittent periodic duty"
Rated impulse withstand voltage $U_{imp}$	8 kV
Rated insulation voltage $U_i$	690 V

### Auxiliary circuit according to IEC/EN

Type	TF140DU
Rated operational voltage $U_e$	500 V AC, 440 V DC
Conventional free air thermal current $I_{th}$	N.C., 95-96 10 A N.O., 97-98 6 A
Rated frequency	DC, 50/60 Hz
Number of poles	1 N.O. + 1 N.C.
$I_e$ / Rated operational current AC-15 acc. to IEC/EN 60947-5-1 for utilization category	
110-120 V	N.C., 95-96 3.00 A N.O., 97-98 1.50 A
220-230-240 V	N.C., 95-96 1.50 A N.O., 97-98 1.50 A
440 V	N.C., 95-96 1.00 A N.O., 97-98 1.00 A
480-500 V	N.C., 95-96 1.00 A N.O., 97-98 1.00 A
$I_e$ / Rated operational current DC-13 acc. to IEC/EN 60947-5-1 for utilization category	
24 V	N.C., 95-96 1.25 A N.O., 97-98 1.25 A
60 V	N.C., 95-96 0.25 A N.O., 97-98 0.25 A
110-120-125 V	N.C., 95-96 0.25 A N.O., 97-98 0.25 A
250 V	N.C., 95-96 0.12 A N.O., 97-98 0.04 A
Minimum switching capacity	17 V / 3 mA
Short-circuit protective device	N.C., 95-96 10 A, Fuse type gG N.O., 97-98 6 A, Fuse type gG
Rated impulse withstand voltage $U_{imp}$	6 kV
Rated insulation voltage $U_i$	690 V

### Technical diagram – Intermittent periodic duty

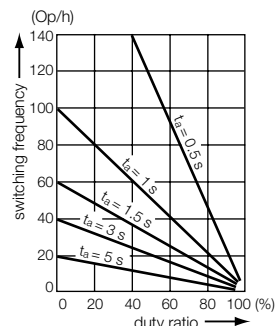

$t_s$ : Motor starting time

# TF140DU thermal overload relays

## Technical data

### Main circuit – Utilization characteristics according to UL/CSA

Type	TF140DU
Standards	UL 60947-1 / 60947-4-1A and CSA 60947-1 / 60947-4-1A
Maximum operational voltage	600 V AC
Trip rating	125 % of FLA
Full load amps (FLA)	See table "Full load amps and short-circuit protective device"
Short-circuit rating RMS symmetrical	See table "Full load amps and short-circuit protective device"
Short-circuit protective device	See table "Full load amps and short-circuit protective device"

### Auxiliary circuit according to UL/CSA

Type	TF140DU
Contact rating	N.C., 95-96 B600 N.O., 97-98 C300
Conventional thermal current	N.C./N.O. 10 A / 6 A

### Full load amps and short-circuit protective device

Type	Full load amps (FLA)	Short-circuit protective device		480 / 600 V AC		480 / 600 V AC		Listed circuit breaker
		Short circuit rating RMS symmetrical	Fuse type	Short circuit rating RMS symmetrical	Fuse type	Short circuit rating RMS symmetrical		
TF140DU-90	90 A	10 kA	250 A, K5 / RK5	100 kA	250 A, Class J	100 kA	250 A	250 A
TF140DU-110	110 A	10 kA	250 A, K5 / RK5	100 kA	250 A, Class J	100 kA	250 A	250 A
TF140DU-135	135 A	10 kA	250 A, K5 / RK5	100 kA	250 A, Class J	100 kA	250 A	250 A
TF140DU-142	142 A	10 kA	250 A, K5 / RK5	100 kA	250 A, Class J	100 kA	250 A	250 A

# TF140DU thermal overload relays



## Technical data

### General technical data





Type	TF140DU	
Pollution degree	3	
Phase loss sensitive	Yes	
Ambient air temperature		
Operation	Open - compensated	-25 ... +55 °C
	Open	-25 ... +55 °C
Storage	-40 ... +70 °C	
Ambient air temperature compensation	Acc. to IEC/EN 60947-4-1	
Maximum operating altitude permissible	2000 m	
Resistance to shock acc. to IEC 60068-2-27	12g / 11 ms	
Mounting position	Position 1-5	
Mounting	Mount on the contactor and tighten the screws of the main circuit terminals	
Degree of protection	Housing	IP20
	Main circuit terminals	IP00

### Electrical connection

#### Main circuit

Type	TF140DU	
Connecting capacity		
 Rigid	1 x	16 ... 70 mm <sup>2</sup>
	2 x	-
 Flexible	1 x	16 ... 70 mm <sup>2</sup>
	2 x	-
	1 x or 2 x	AWG 6-2/0
Stranded acc. to UL/CSA	1 x or 2 x	AWG 6-2/0
Flexible acc. to UL/CSA	1 x or 2 x	AWG 6-2/0
Stripping length	25 mm	
Tightening torques	8 ... 10 Nm / 77 ... 88 lb.in	
Connection screw	M8 (Hexagon)	

#### Auxiliary circuit

Type	TF140DU	
Connecting capacity		
 Rigid	1 x or 2 x	0.75 ... 4 mm <sup>2</sup>
 Flexible with ferrule	1 x or 2 x	0.75 ... 2.5 mm <sup>2</sup>
 Flexible with insulated ferrule	1 x or 2 x	0.75 ... 2.5 mm <sup>2</sup>
 Flexible	1 x or 2 x	0.75 ... 2.5 mm <sup>2</sup>
	1 x or 2 x	AWG 18-14
Stranded acc. to UL/CSA	1 x or 2 x	AWG 18-14
Flexible acc. to UL/CSA	1 x or 2 x	AWG 18-14
Stripping length	9 mm	
Tightening torques	0.8 ... 1.3 Nm / 12 lb.in	
Connection screw	M3.5 (Pozi driv 2)	

# TA200DU thermal overload relays

## Technical data

### Main circuit – Utilization characteristics according to IEC/EN

Type	TA200DU
Standards	IEC/EN 60947-1, IEC/EN 60947-4-1
Rated operational voltage $U_e$	690 V AC
Rated frequency	DC, 50/60 Hz
Frequency range	0 ... 400 Hz
Trip class	10A
Number of poles	3
Duty time	100 %
Operating frequency without early tripping	Up to 15 operations/h, see "Technical diagram – Intermittent periodic duty"
Rated impulse withstand voltage $U_{imp}$	6 kV
Rated insulation voltage $U_i$	690 V AC

### Auxiliary circuit according to IEC/EN

Type	TA200DU
Rated operational voltage $U_e$	500 V AC, 440 V DC
Conventional free air thermal current $I_{th}$	N.C., 95-96 10 A N.O., 97-98 6 A
Rated frequency	DC, 50/60 Hz
Number of poles	1 N.O. + 1 N.C.
$I_e$ / Rated operational current AC-15 acc. to IEC/EN 60947-5-1 for utilization category	
110-120 V	N.C., 95-96 3.00 A N.O., 97-98 1.50 A
220-230-240 V	N.C., 95-96 3.00 A N.O., 97-98 1.50 A
440 V	N.C., 95-96 1.00 A N.O., 97-98 1.00 A
480-500 V	N.C., 95-96 1.00 A N.O., 97-98 1.00 A
$I_e$ / Rated operational current DC-13 acc. to IEC/EN 60947-5-1 for utilization category	
24 V	N.C., 95-96 1.25 A N.O., 97-98 1.25 A
60 V	N.C., 95-96 0.25 A N.O., 97-98 0.25 A
110-120-125 V	N.C., 95-96 0.25 A N.O., 97-98 0.25 A
250 V	N.C., 95-96 0.12 A N.O., 97-98 0.04 A
Minimum switching capacity	17 V / 3 mA
Short-circuit protective device	N.C., 95-96 10 A, Fuse type gG N.O., 97-98 6 A, Fuse type gG
Rated impulse withstand voltage $U_{imp}$	6 kV
Rated insulation voltage $U_i$	690 V

### Technical diagram – Intermittent periodic duty

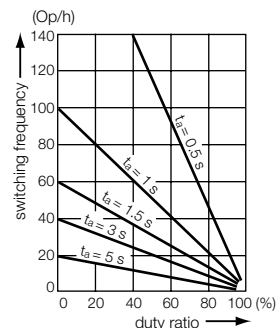

$t_a$ : Motor starting time



# TA200DU thermal overload relays

## Technical data

### Main circuit – Utilization characteristics according to UL/CSA

Type	TA200DU
Standards	UL 60947-1 / 60947-4-1A and CSA 60947-1 / 60947-4-1A
Maximum operational voltage	600 V AC
Trip rating	125 % of FLA
Full load amps (FLA)	See table "Full load amps and short-circuit protective device"
Short-circuit rating RMS symmetrical	See table "Full load amps and short-circuit protective device"
Short-circuit protective device	See table "Full load amps and short-circuit protective device"

### Auxiliary circuit according to UL/CSA

Type	TA200DU
Contact rating	N.C., 95-96 : C600 N.O., 97-98 : B600
Conventional thermal current	5 A

### Full load amps and short-circuit protective device

Type	Full load amps (FLA)	Short-circuit protective device						
		480 / 600 V AC		Listed circuit breaker	Short circuit rating RMS symmetrical	Fuse type	Short circuit rating RMS symmetrical	Listed circuit breaker
Short circuit rating RMS symmetrical	Fuse type							
TA200DU-90	90 A	10 kA	250 A, K5 / RK5	225 A	100 kA	250 A, Class J	100 kA	250 A
TA200DU-110	110 A	10 kA	250 A, K5 / RK5	225 A	100 kA	250 A, Class J	100 kA	250 A
TA200DU-135	135 A	10 kA	300 A, K5 / RK5	225 A	100 kA	250 A, Class J	100 kA	250 A
TA200DU-150	150 A	10 kA	300 A, K5 / RK5	225 A	100 kA	250 A, Class J	100 kA	250 A
TA200DU-175	175 A	10 kA	300 A, K5 / RK5	225 A	100 kA	300 A, Class J	100 kA	300 A
TA200DU-200	200 A	10 kA	400 A, K5 / RK5	400 A	100 kA	400 A, Class J	100 kA	400 A



# TA200DU thermal overload relays

## Technical data





### General technical data

Type	TA200DU	
Pollution degree	3	
Phase loss sensitive	Yes	
Ambient air temperature		
Operation	Open - compensated	-25 ... +55 °C
	Open	-25 ... +55 °C
Storage		-40 ... +70 °C
Ambient air temperature compensation	Acc. to IEC/EN60947-4-1	
Maximum operating altitude permissible	2000 m	
Resistance to shock acc. to IEC 60068-2-27	12g / 15 ms	
Mounting position	Position 1-6	
Mounting	Mount on the contactor and tighten the screws of the main circuit terminals or with single mounting kit	
Degree of protection	Housing	IP20
	Main circuit terminals	IP00

### Electrical connection

Main circuit			
Type	TA200DU		
Connecting capacity			
	Rigid	1 x	25 ... 120 mm <sup>2</sup>
	Flexible	1 x	25 ... 120 mm <sup>2</sup>
	Stranded acc. to UL/CSA	1 x	AWG 4 ... 0000
	Flexible acc. to UL/CSA	1 x	AWG 4 ... 0000
	Lugs		L > 10 mm
Tightening torques	25 Nm / 220 lb.in		
Connection screw	Open bars		

### Auxiliary circuit

Type	TA200DU		
Connecting capacity			
	Rigid	1 x or 2 x	0.75 ... 4 mm <sup>2</sup>
	Flexible with ferrule	1 x or 2 x	0.75 ... 2.5 mm <sup>2</sup>
	Flexible with insulated ferrule	1 x or 2 x	0.75 ... 2.5 mm <sup>2</sup>
	Flexible	1 x or 2 x	0.75 ... 2.5 mm <sup>2</sup>
	Stranded acc. to UL/CSA	1 x or 2 x	AWG 18 ... 14
	Flexible acc. to UL/CSA	1 x or 2 x	AWG 18 ... 14
Stripping length	9 mm		
Tightening torques	0.8 ... 1.3 Nm / 12 lb.in		
Connection screw	M3.5 (Pozidriv 2)		

# EF19, EF45 electronic overload relays

## Technical data

### Main circuit – Utilization characteristics according to IEC/EN

Type	EF19	EF45
Standards	IEC/EN 60947-1, IEC/EN 60947-4-1, IEC/EN 60947-5-1	
Rated operational voltage $U_n$	690 V AC	
Rated frequency	50/60 Hz – not suitable for DC applications	
Trip class	10E, 20E, 30E, selectable	
Number of poles	3	
Duty time	100 %	
Operating frequency without early tripping	Up to 15 operations/h, see "Technical diagram – Intermittent periodic duty"	
Rated impulse withstand voltage $U_{imp}$	6 kV	
Rated insulation voltage $U_i$	690 V AC	

### Auxiliary circuit according to IEC/EN

Type	EF19	EF45
Rated operational voltage $U_n$	600 V AC / DC	
Conventional free air thermal current $I_n$	6 A	
Rated frequency	DC, 50/60 Hz	
Number of poles	1 N.C. + 1 N.O.	
$I_n$ / Rated operational current AC-15 acc. to IEC/EN 60947-5-1 for utilization category		
110-120 V	50/60 Hz	3.00 A
220-230-240 V	50/60 Hz	3.00 A
440 V	50/60 Hz	1.10 A
480-500 V	50/60 Hz	0.75 A
$I_n$ / Rated operational current DC-13 acc. to IEC/EN 60947-5-1 for utilization category		
24 V		1.50 A
60 V		0.55 A
110-120-125 V		0.55 A
250 V		0.27 A
Minimum switching capacity	12 V / 3 mA	
Short-circuit protective device	6 A, Fuse type gG	
Rated impulse withstand voltage $U_{imp}$	6 kV	
Rated insulation voltage $U_i$	690 V	

### Technical diagram – Intermittent periodic duty

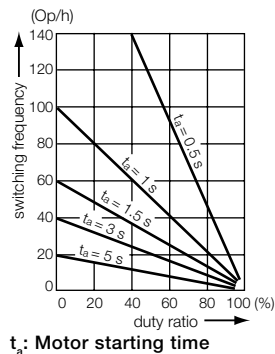

# EF19, EF45 electronic overload relays

## Technical data

### Main circuit – Utilization characteristics according to UL/CSA

Type	EF19	EF45
Standards	UL 60947-1 / 60947-4-1A and CSA 60947-1 / 60947-4-1A	
Maximum operational voltage	600 V AC	
Trip rating	125 % of FLA	
Full load amps (FLA)	See table "Full load amps and short-circuit protective device"	
Short-circuit rating RMS symmetrical	See table "Full load amps and short-circuit protective device"	
Short-circuit protective device	See table "Full load amps and short-circuit protective device"	

### Auxiliary circuit according to UL/CSA

Type	EF19	EF45
Contact rating	N.C., 95-96 N.O., 97-98	B600, Q600 B600, Q600
Conventional thermal current	5 A	

### Full load amps and short-circuit protective device

Type	Full load amps (FLA)	Short-circuit protective device					
		480 V AC		600 V AC			
		SCCR	Fuse type	SCCR	Fuse type	SCCR	Fuse type
EF19-0.32	0.32 A	50 kA	2 A, Class J	5 kA	2 A, K5 / RK5	100 kA	2 A, Class J
EF19-1.0	1.00 A	50 kA	2 A, K5 / RK5	5 kA	2 A, K5 / RK5	100 kA	2 A, Class J
EF19-2.7	2.70 A	50 kA	4 A, K5 / RK5	5 kA	4 A, K5 / RK5	100 kA	4 A, Class J
EF19-6.3	6.30 A	50 kA	15 A, K5 / RK5	5 kA	15 A, K5 / RK5	100 kA	15 A, Class J
EF19-18.9	18.90 A	50 kA	30 A, K5 / RK5	5 kA	30 A, K5 / RK5	100 kA	30 A, Class J

Type	Full load amps (FLA)	Short-circuit protective device					
		480 V AC		600 V AC			
		SCCR	Fuse type	SCCR	Fuse type	SCCR	Fuse type
EF45-30	30 kA	18 kA	150 A, K5 / RK5	18 kA	150 A, K5 / RK5	100 kA	150 A, Class J
EF45-45	45 kA	18 kA	200 A, K5 / RK5	18 kA	200 A, K5 / RK5	100 kA	200 A, Class J

# EF19, EF45 electronic overload relays



## Technical data

### General data





		EF19	EF45
Type		EF19	EF45
Pollution degree		3	
Phase loss sensitive		Yes	
Ambient air temperature			
Operation	Open - compensated	-25 ... +70 °C	
Storage		-50 ... +85 °C	
Ambient air temperature compensation		Acc. to IEC/EN60947-4-1	
Maximum operating altitude permissible		2000 m	
Resistance to shock acc. to IEC 60068-2-27		15g / 11 ms	
Resistance to vibrations acc. to IEC 60068-2-6		1g / 3 ... 150 Hz	
Mounting position		Position 1-6	
Mounting		Mount on the contactor and tighten the screws of the main circuit terminals	
Degree of protection	Housing	IP20	
	Main circuit terminals	IP20	

### Electrical connection

#### Main circuit

		EF19	EF45
Type		EF19	EF45
Connecting capacity			
 Rigid	1 or 2 x	1 ... 4 mm <sup>2</sup>	2.5 ... 16 mm <sup>2</sup>
 Flexible with insulated ferrule	1 or 2 x	0.75 ... 2.5 mm <sup>2</sup>	2.5 ... 10 mm <sup>2</sup>
Stranded acc. to UL/CSA	1 or 2 x	AWG 16-10	AWG 14-6
Flexible acc. to UL/CSA	1 or 2 x	AWG 16-10	AWG 14-6
Stripping length		9 mm	13 mm
Tightening torques		0.8 ... 1.5 Nm / 7 ... 13 lb.in	2.3 ... 2.6 Nm / 20 ... 22 lb.in
Connection screw		M3.5 (Pozidriv 2)	

#### Auxiliary circuit

		EF19	EF45
Type		EF19	EF45
Connecting capacity			
 Rigid	1 or 2 x	1 ... 4 mm <sup>2</sup>	
 Flexible with ferrule	1 or 2 x	0.75 ... 2.5 mm <sup>2</sup>	
 Flexible with insulated ferrule	1 or 2 x	0.75 ... 2.5 mm <sup>2</sup>	
 Flexible	1 or 2 x	0.75 ... 2.5 mm <sup>2</sup>	
Stranded acc. to UL/CSA	1 or 2 x	AWG 18-10	
Flexible acc. to UL/CSA	1 or 2 x	AWG 18-10	
Stripping length		9 mm	
Tightening torques		0.8 ... 1.2 Nm / 7 ... 11 lb.in	
Connection screw		M3 (Pozidriv 2)	

# EF65, EF96, EF146 electronic overload relays

## Technical data

3

### Main circuit – Utilization characteristics according to IEC/EN

Type	EF65, EF96, EF146
Standards	IEC/EN 60947-1, IEC/EN 60947-4-1, IEC/EN 60947-5-1
Rated operational voltage $U_e$	1000 V AC
Rated frequency	50/60 Hz – not suitable for DC applications
Trip class	10E, 20E, 30E, selectable
Number of poles	3
Duty time	100 %
Operating frequency without early tripping	Up to 15 operations/h, see "Technical diagram – Intermittent periodic duty"
Rated impulse withstand voltage $U_{imp}$	8 kV
Rated insulation voltage $U_i$	1000 V

### Auxiliary circuit according to IEC/EN

Type	EF65, EF96, EF146
Rated operational voltage $U_e$	600 V AC / DC
Conventional free air thermal current $I_{th}$	6 A
Rated frequency	DC, 50/60 Hz
Number of poles	1 N.C. + 1 N.O.
$I_e$ / Rated operational current AC-15 acc. to IEC/EN 60947-5-1 for utilization category	
110-120 V 50/60 Hz	3.00 A
220-230-240 V 50/60 Hz	3.00 A
400 V 50/60 Hz	1.10 A
480-500 V 50/60 Hz	0.75 A
$I_e$ / Rated operational current DC-13 acc. to IEC/EN 60947-5-1 for utilization category	
24 V	1.50 A
60 V	0.55 A
110-120-125 V	0.55 A
250 V	0.27 A
Minimum switching capacity	12 V / 3 mA
Short-circuit protective device	6 A, Fuse type gG
Rated impulse withstand voltage $U_{imp}$	6 kV
Rated insulation voltage $U_i$	690 V

### Technical diagram – Intermittent periodic duty

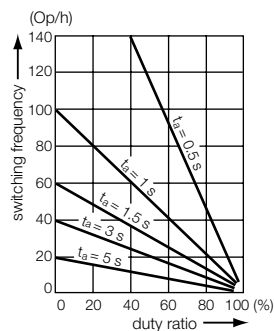

$t_a$ : Motor starting time

# EF65, EF96, EF146 electronic overload relays

## Technical data

### Main circuit – Utilization characteristics according to UL/CSA

Type	EF65, EF96, EF146
Standards	UL 60947-1 / 60947-4-1A and CSA 60947-1 / 60947-4-1A
Maximum operational voltage	600 V AC
Trip rating	125 % of FLA
Full load amps (FLA)	See table "Full load amps and short-circuit protective device"
Short-circuit rating RMS symmetrical	See table "Full load amps and short-circuit protective device"
Short-circuit protective device	See table "Full load amps and short-circuit protective device"

### Auxiliary circuit according to UL/CSA

Type	EF65, EF96, EF146
Contact rating	N.C., 95-96 B600, Q600 N.O., 97-98 B600, Q600
Conventional thermal current	6 A

### Full load amps and short-circuit protective device

Type	Full load amps (FLA)	Short-circuit protective device		600 V AC			
		480 V AC		SCCR		Fuse type	
		SCCR	Fuse type	SCCR	Fuse type	SCCR	Fuse type
EF65-70	70 A	10 kA	150 A, R5/RK5	10kA	150 A, R5/RK5	100 kA	175 A, J
EF96-100	100 A	10 kA	200 A, R5/RK5	10kA	200 A, R5/RK5	100 kA	225 A, J
EF146-150	150 A	10 kA	250 A, R5/RK5	10kA	250 A, R5/RK5	100 kA	350 A, J

# EF65, EF96, EF146 electronic overload relays



## Technical data

### General data





Type	EF65, EF96, EF146	
Pollution degree	3	
Phase loss sensitive	Yes	
Ambient air temperature		
Operation	Open - compensated	-25 ... +70 °C
Storage		-50 ... +85 °C
Ambient air temperature compensation	Acc. to IEC/EN 60947-4-1	
Maximum operating altitude permissible	2000 m	
Resistance to shock acc. to IEC 60068-2-27	15g / 11 ms	
Resistance to vibrations acc. to IEC 60068-2-6	5g / 3 ... 150 Hz	
Mounting position	Position 1-6	
Mounting	Mount on the contactor and tighten the screws of the main circuit terminals	
Degree of protection	Housing	IP20
	Main circuit terminals	IP10

### Electrical connection

#### Main circuit

Type		EF65	EF96	EF146
Connecting capacity				
 Rigid	1 x	4 ... 35 mm <sup>2</sup>	6 ... 70 mm <sup>2</sup>	10 ... 95 mm <sup>2</sup>
	2 x	4 ... 35 mm <sup>2</sup>	6 ... 35 mm <sup>2</sup>	10 ... 35 mm <sup>2</sup>
 Flexible	1 x	4 ... 35 mm <sup>2</sup>	6 ... 50 mm <sup>2</sup>	10 ... 70 mm <sup>2</sup>
	2 x	4 ... 35 mm <sup>2</sup>	6 ... 35 mm <sup>2</sup>	10 ... 35 mm <sup>2</sup>
	1 x	AWG 10-2	AWG 8-2	AWG 6-00
Stranded acc. to UL/CSA	2 x			AWG 6-2
	1 x	AWG 10-2	AWG 8-2	AWG 6-00
Flexible acc. to UL/CSA	2 x			AWG 6-2
Stripping length		20 mm	20 mm	20 mm
Tightening torques		4 Nm / 35 lb.in	6 Nm / 55 lb.in	8 Nm / 70 lb.in
Connection screw		M8 (Pozi driv 2)	M8 (Hexagon 4)	M8 (Hexagon 4)

#### Auxiliary circuit

Type	EF65, EF96, EF146		
Connecting capacity			
 Rigid	1 or 2 x	1 ... 4 mm <sup>2</sup>	
 Flexible with ferrule	1 or 2 x	0.75 ... 2.5 mm <sup>2</sup>	
 Flexible with insulated ferrule	1 or 2 x	0.75 ... 2.5 mm <sup>2</sup>	
 Flexible	1 or 2 x	0.75 ... 2.5 mm <sup>2</sup>	
Stranded acc. to UL/CSA	1 or 2 x	AWG 18-10	
Flexible acc. to UL/CSA	1 or 2 x	AWG 18-10	
Stripping length		9 mm	
Tightening torques		0.8 ... 1.2 Nm / 7 ... 11 lb.in	
Connection screw		M3.5 (Pozi driv 2)	



# EF205, EF370 electronic overload relays

## Technical data

### Main circuit – Utilization characteristics according to IEC/EN

Type	EF205, EF370
Standards	IEC/EN 60947-1, IEC/EN 60947-4-1, IEC/EN 60947-5-1
Rated operational voltage $U_n$	1000 V AC
Rated frequency	50/60 Hz – not suitable for DC applications
Trip class	10E, 20E, 30E, selectable
Number of poles	3
Duty time	100 %
Operating frequency without early tripping	Up to 15 operations/h, see "Technical diagram – Intermittent periodic duty"
Rated impulse withstand voltage $U_{imp}$	8 kV
Rated insulation voltage $U_i$	1000 V

### Auxiliary circuit according to IEC/EN

Type	EF205, EF370
Rated operational voltage $U_n$	600 V AC / DC
Conventional free air thermal current $I_n$	6 A
Rated frequency	DC, 50/60 Hz
Number of poles	1 N.C. + 1 N.O.
$I_n$ / Rated operational current AC-15 acc. to IEC/EN 60947-5-1 for utilization category	
110-120 V	50/60 Hz : 3.00 A
220-230-240 V	50/60 Hz : 3.00 A
400 V	50/60 Hz : 1.10 A
480-500 V	50/60 Hz : 0.75 A
$I_n$ / Rated operational current DC-13 acc. to IEC/EN 60947-5-1 for utilization category	
24 V	1.50 A
60 V	0.55 A
110-120-125 V	0.55 A
250 V	0.27 A
Minimum switching capacity	12 V / 3 mA
Short-circuit protective device	6 A, Fuse type gG
Rated impulse withstand voltage $U_{imp}$	6 kV
Rated insulation voltage $U_i$	690 V

### Technical diagram – Intermittent periodic duty

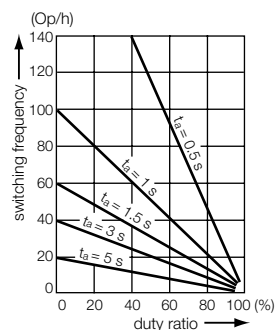

$t_a$ : Motor starting time

# EF205, EF370 electronic overload relays

## Technical data

### Main circuit – Utilization characteristics according to UL/CSA

Type	EF205, EF370
Standards	UL 60947-1 / 60947-4-1A and CSA 60947-1 / 60947-4-1A
Maximum operational voltage	600 V AC
Trip rating	125 % of FLA
Full load amps (FLA)	See table "Full load amps and short-circuit protective device"
Short-circuit rating RMS symmetrical	See table "Full load amps and short-circuit protective device"
Short-circuit protective device	See table "Full load amps and short-circuit protective device"

### Auxiliary circuit according to UL/CSA

Type	EF205, EF370
Contact rating	N.C., 95-96 N.O., 97-98
	B600, Q600 B600, Q600
Conventional thermal current	6 A

### Full load amps and short-circuit protective device

Type	Full load amps (FLA)	Short-circuit protective device		600 V AC			
		480 V AC	Fuse type	SCCR	Fuse type	SCCR	Fuse type
EF205-210	210 A	10 kA	400 A, R5/RK5	10kA	400 A, R5/RK5	100 kA	400 A, J
EF370-380	380 A	18 kA	800 A, L/T	18kA	800 A, L/T	-	-

# EF205, EF370 electronic overload relays





## Technical data

### General data





Type	EF205, EF370	
Pollution degree	3	
Phase loss sensitive	Yes	
Ambient air temperature		
Operation	Open - compensated	-25 ... +70 °C
Storage		-50 ... +85 °C
Ambient air temperature compensation	Acc. to IEC/EN 60947-4-1	
Maximum operating altitude permissible	2000 m	
Resistance to shock acc. to IEC 60068-2-27	25g / 11 ms	
Resistance to vibrations acc. to IEC 60068-2-6	5g / 3 ... 150 Hz	
Mounting position	Position 1-6	
Mounting	Mount on the contactor and tighten the screws of the main circuit terminals	
Degree of protection	Housing	IP20
	Main circuit terminals	IP20

### Electrical connection

#### Main circuit

Type	EF205	EF370
Connecting capacity		
 Rigid	1 x 16 ... 185 mm <sup>2</sup> 2 x 16 ... 120 mm <sup>2</sup>	50 ... 240 mm <sup>2</sup> 50 ... 150 mm <sup>2</sup>
 Flexible	1 x 16 ... 185 mm <sup>2</sup> 2 x 16 ... 120 mm <sup>2</sup>	50 ... 240 mm <sup>2</sup> 50 ... 150 mm <sup>2</sup>
 Lugs	L ≤ 24 mm	32 mm
 Bars	Ø > 8 mm	10 mm
Stranded acc. to UL/CSA	1 x AWG 6-0000 2 x AWG 6-0000	AWG 1-500 kcmil AWG 1-500 kcmil
Flexible acc. to UL/CSA	1 x AWG 6-0000 2 x AWG 6-0000	AWG 1-500 kcmil AWG 1-500 kcmil
Stripping length	-	-
Tightening torques	18 Nm / 160 lb.in	28 Nm / 247 lb.in
Connection screw	M8	M10

#### Auxiliary circuit

Type	EF205, EF370
Connecting capacity	
 Rigid	1 or 2 x 1 ... 4 mm <sup>2</sup>
 Flexible with ferrule	1 or 2 x 0.75 ... 2.5 mm <sup>2</sup>
 Flexible with insulated ferrule	1 or 2 x 0.75 ... 2.5 mm <sup>2</sup>
 Flexible	1 or 2 x 0.75 ... 2.5 mm <sup>2</sup>
Stranded acc. to UL/CSA	1 or 2 x AWG 18-10
Flexible acc. to UL/CSA	1 or 2 x AWG 18-10
Stripping length	9 mm
Tightening torques	0.8 ... 1.2 Nm / 7 ... 11 lb.in
Connection screw	M3.5 (Pozi driv 2)

# E500DU, E800DU, E1250DU electronic overload relays

## Technical data

### Main circuit – Utilization characteristics according to IEC/EN

Type	E500DU	E800DU	E1250DU
Standards	IEC/EN 60947-1, IEC/EN 60947-4-1, IEC/EN 60947-5-1		
Rated operational voltage $U_n$	1000 V AC		
Rated frequency	50/60 Hz – not suitable for DC applications		
Trip class	10E, 20E, 30E, selectable		
Number of poles	3		
Duty time	100 %		
Operating frequency without early tripping	Up to 15 operations/h, see "Technical diagram – Intermittent periodic duty"		
Rated impulse withstand voltage $U_{imp}$	8 kV		
Rated insulation voltage $U_i$	1000 V AC		

### Auxiliary circuit according to IEC/EN

Type	E500DU	E800DU	E1250DU
Rated operational voltage $U_n$	600 V AC / DC		
Conventional free air thermal current $I_{th}$	6 A		
Rated frequency	DC, 50/60 Hz		
Number of poles	1 N.C. + 1 N.O.		
$I_n$ / Rated operational current AC-15 acc. to IEC/EN 60947-5-1 for utilization category			
110-120 V	50/60 Hz	3.00 A	
220-230-240 V	50/60 Hz	3.00 A	
440 V	50/60 Hz	1.10 A	
480-500 V	50/60 Hz	0.72 A	
$I_n$ / Rated operational current DC-13 acc. to IEC/EN 60947-5-1 for utilization category			
24 V		1.50 A	
60 V		0.55 A	
110-120-125 V		0.55 A	
250 V		0.27 A	
Minimum switching capacity	12 V / 3 mA		
Short-circuit protective device	6 A, Fuse type gG		
Rated impulse withstand voltage $U_{imp}$	8 kV		
Rated insulation voltage $U_i$	690 V		

### Technical diagram – Intermittent periodic duty

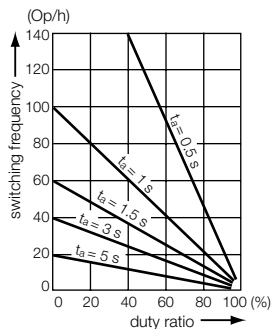

# E500DU, E800DU, E1250DU electronic overload relays

## Technical data

### Main circuit – Utilization characteristics according to UL/CSA

Type	E500DU	E800DU	E1250DU
Standards	UL 60947-1 / 60947-4-1A and CSA 60947-1 / 60947-4-1A		
Maximum operational voltage	600 V AC		
Trip rating	125 % of FLA		

### Auxiliary circuit according to UL/CSA





Type	E500DU	E800DU	E1250DU
Contact rating	N.C., 95-96	B600, Q300	
	N.O., 97-98	B600, Q300	
Conventional thermal current	5 A		

### General data

Type	E500DU	E800DU	E1250DU
Pollution degree	3		
Phase loss sensitive	Yes		
Ambient air temperature			
Operation	Open - compensated	-25 ... +70 °C	
Storage		-50 ... +85 °C	
Ambient air temperature compensation	Acc. to IEC/EN60947-4-1		
Maximum operating altitude permissible	2000 m		
Resistance to shock acc. to IEC 60068-2-27	15g / 11 ms		
Resistance to vibrations acc. to IEC 60068-2-6	5g / 3 ... 150 Hz		
Degree of protection	Housing	IP20	
	Main circuit terminals	IP20	

### Electrical connection

#### Auxiliary circuit

Type	E500DU	E800DU	E1250DU
Connecting capacity			
 Rigid	1 or 2 x	1 ... 4 mm <sup>2</sup>	
 Flexible with ferrule	1 or 2 x	0.75 ... 2.5 mm <sup>2</sup>	
 Flexible with insulated ferrule	1 or 2 x	0.75 ... 2.5 mm <sup>2</sup>	
 Flexible	1 or 2 x	0.75 ... 2.5 mm <sup>2</sup>	
Stranded acc. to UL/CSA	1 or 2 x	AWG 16-10	
Flexible acc. to UL/CSA	1 or 2 x	AWG 16-10	
Stripping length	9 mm		
Tightening torques	0.8 ... 1.2 Nm / 7 lb.in		
Connection screw	M3.5 (Pozidriv 2)		

Lined area for notes, consisting of numerous horizontal dotted lines.

# General technical data and additional ratings

## Table of contents

- Coordination with short-circuit protective devices.....4.2 - 4.3
- Standards, specifications and certifying organizations .....4.4 - 4.5
- Terms and technical definitions.....4.6 - 4.7
- Standards and utilization categories .....4.8 - 4.9
- Degrees of protection .....4.10
- Climatic withstand of devices .....4.11
- Electrical cross-reference .....4.12 - 4.13
- North American HVAC applications.....4.14
- CSA elevator applications .....4.15
- North American lighting applications.....4.16
- Pilot duty and overload trip classes .....4.17
- DC circuit switching, AF09 ... AF96 contactors .....4.18

# Coordination with short-circuit protection devices

In compliance with standards IEC 60947-4-1 and EN 60947-4-1, we define for the contactors and starters the type, rating and characteristics of the short-circuit protection devices SCPD which allow selective protection against overloads and ensure protection against short circuits.

## Basic functions

Any starter is designed to:

- start motors,
- ensure continuous functioning of motors,
- disconnect motors from the supply line,
- guarantee protection of motors against overloads.

The starter is typically made up of a switching device (contactor) and an overload protection device (thermal overload relay or electronic overload relay).

4

These two devices MUST be coordinated with equipment capable of providing protection against short circuit (SCPD: short circuit protective device): typically a circuit breaker with magnetic release only or a switch fuse. These are not necessarily part of the starter.

## Applicable standards

IEC 60947-4-1 (EN 60947-4-1) precisely defines the different points to be considered in order to carry out correct coordination.

Complete coordination for a combination includes the following points:

- Selectivity test between the overload relay and the short-circuit protection device SCPD.
- Short-circuit condition tests:
  - at prospective "r" currents - These currents depend on the rated operational current of the starter (**I<sub>e</sub> AC-3**) and are given by the standard (Table 13). For example:
    - r = 1kA for **I<sub>e</sub> AC-3** < 16 A
    - r = 3 kA for 16 A < **I<sub>e</sub> AC-3** < 63 A
    - r = 5 kA for 63 A < **I<sub>e</sub> AC-3** < 125 A etc.
  - at the rated conditional short-circuit current "**I<sub>q</sub>**" - This is the maximum prospective current that the combination can withstand, for example 50 kA.

## Types of coordination

IEC 60947-4-1 (EN 60947-4-1) defines two types of coordination according to the expected level of service continuity. Acceptable extreme damage for the switchgear is divided into two types.

**Type 1:** In short-circuit conditions, the contactor or starter does not endanger persons or installations and will not be able to then operate without being repaired or having parts replaced.

**Type 2:** In short-circuit conditions, the contactor or starter does not endanger persons or installations and will be able to operate afterwards. The risk of contacts light welding is acceptable. In this case, the manufacturer must stipulate the measures to be taken with respect to maintenance of the equipment.

## The complete ABB offer

ABB has acquired years of experience with respect to problems of coordination and is able to make a complete offer based on tests performed in its qualified laboratories. This offer includes 400 V, 500 V, 690 V networks.

**A complete data base of coordination tables**, according to IEC 60947-4-1 (EN 60947-4-1), is available on the ABB Website.

In the coordination tables the following short-circuit protection devices are recommended:

- Moulded case circuit-breakers (MCCBs)
- Miniature circuit-breakers (MCBs)
- Switch-disconnector-fuses (aM, gG and BS)
- Manual Motor Starters (MMS).

## General remarks applicable to all tables

- Each table is defined for a maximum ambient temperature of 40 °C. For higher temperatures, apply a derating factor according to the following rules:
  - Fuses: factor of 0.8 applied to **I<sub>n</sub>** for an ambient temperature of 70 °C
  - MCCBs and MCBs: factor of 0.8 applied to **I<sub>n</sub>** for an ambient temperature of 60 °C
  - The starter derating factor depends on the operating conditions of thermal overload relays:
    - Factor of 0.9 applied to **I<sub>n</sub>** for an ambient temperature of 70 °C.
- Each table is defined for motor currents: 3-phase motors, 4-pole
- **Normal starting** means a starting time < 2 s. - **Difficult starting** means an accelerating time 10 s < **t<sub>s</sub>** < 30 s
- **Tripping classes** of thermal overload relays according to IEC 60947-4-1 (EN 60947-4-1): 10A and 10
- **Tripping classes** of electronic overload relays according to IEC 60947-4-1 (EN 60947-4-1): 10E, 20E, 30E selectable
- In the tables with MCCBs, these are fitted with the magnetic relay alone. Setting is always carried out at > 12.3 **I<sub>e</sub> AC-3** so that the transient current peak occurring during starting does not lead to tripping.



# Coordination with short-circuit protection devices

A complete data base of coordination tables, according to [IEC 60947-4-1](#) (EN 60947-4-1) or [UL 508 / UL 60947-4-1](#), is available on the ABB Website: see below.

## Selection

Simple or multiple selections all from the same screen.

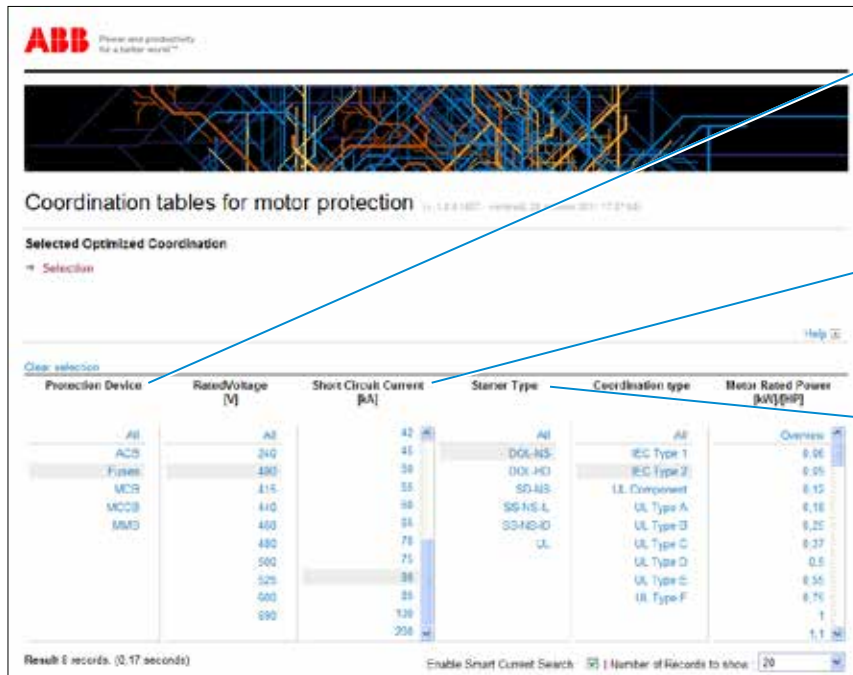

### Short-circuit protection devices

- Air circuit breakers
- Fuses "gG" or "aM"
- Miniature circuit breaker
- Moulded case circuit breaker
- Manual motor starter

### Starter type

- Direct-on-line normal start
- Direct-on-line heavy duty
- Star-delta normal start
- Soft starter normal start

### Coordination

- IEC type 1 or type 2
- UL type A to Type F

## Results

- Search results displayed at the bottom of the selection page.
- Only the most appropriate solutions to your application, will be displayed at the bottom of the page.
- "Enable Smart Current Search" function featured for the short-circuit current where "near to" selected values also are included in the result.
- Possible to print the page to a pdf file or from your printer.
- "Clear selection" function to deselect all selected.

Fuses, 400 V, 80 kA, DOL-NS, Coordination type IEC Type 2							
Motor	Fuses IEC		Contactor	Overload Relay			
Rated Power Rated Current	Rating gG / aM	Type and Size	Type	Type	Current setting range	Max allowed load current	[A] Table
0.37	1.1 OS32D	2 OFAM 80aM A9	A9	E16DU2 7.10	0.90 - 2.70	1.4	>>>
0.37	1.1 OS32D	2 OFAM 80aM A9	A9	TA25DU 1.4	1.00 - 1.40	1.4	>>>
0.37	1.1 OS32D	2 OFAM 80aM A9	A9	UMC22100 10	0.24 - 53.00	1.4	>>>
0.37	1.1 OS32D	4 OFAA 60H A9	A9	UMC22100 10	0.24 - 53.00	1.3	>>>
0.37	1.1 OS32D	4 OFAA 60H A9	A9	E16DU2 7.10	0.90 - 2.70	1.3	>>>
0.37	1.1 OS32D	4 OFAA 60H A9	A9	TA25DU 1.4	1.00 - 1.40	1.4	>>>

Fuses, 400 V, 80 kA, DOL-NS, Coordination type IEC Type 2, Overload Relay TOL							
Motor	Fuses IEC		Contactor	Overload Relay			
Rated Power Rated Current	Rating gG / aM	Type and Size	Type	Type	Current setting range	Max allowed load current	[A] Table
0.25	6.00 OS32D	2 OFAF 300aM AF09	AF09	TF42 1.6	0.74 - 1.00	1	>>>
0.12	6.44 OS32D	2 OFAF 000H AF09	AF09	TF42 0.65	0.42 - 0.55	0.65	>>>

## Access

To find the coordination tables for motor protection, please see:

[www.abb.com/lowvoltage](http://www.abb.com/lowvoltage) then go to the right menu: "Support", select: "Online Product Selection Tools" then select "Coordination Tables for motor protection"

# Standards, specifications and certifying organizations

## Definitions

ABB low voltage devices are developed and manufactured in accordance with the applicable regulations as stated in the international IEC standards, the European EN standards and the national ones such as NF, DIN, GB and BS. For devices installed in ships, an approval issued by independent classification societies is demanded by the maritime insurance companies.

### CB scheme

Certification Body certificates (CB certificates) are available to prove the complete conformity to standards

The IEC CB (Certification Body) scheme is multilateral agreement between the National Certification Bodies to allow international certification of electrical and electronic products so that a single certification allows worldwide market access.

The CB Scheme was established by the International Electrotechnical Committee for conformity testing to standards for electrical equipment (IECEE).

### Certified products

In some cases, products are validated and tested according to a standard by a certification body and the manufacturer is regularly visited by this body in order to check the respect of the design and the materials used. This process creates a certified product. This is the case of UL (Underwriters Laboratories) and CSA (Canadian Standard Association) for instance (see below).

## Specifications

### International Specifications

The International Electrotechnical Commission, IEC, which is part of the International Standards Organization, ISO, publishes IEC publications which act as a basis for the world market.

### European Specifications and National Specifications

The European committee for electrotechnical standardization (CENELEC), which groups together European countries, publishes EN standards.

These European standards may differ very little from IEC international standards and have similar numbering.

The same applies for national standards which use, without exception, the same numbering and reproduce the texts of these unified standards in their entirety. Contradicting national standards are withdrawn.

### European Directives

The guarantee of the free movement of goods within the European Community means that any regulatory differences between member states have been eliminated. The European directives set up common rules that are included in the legislation of each state while contradictory regulations are cancelled.

Three directives are essential:

- **Low Voltage Directive** 2006/95/EC concerns electrical equipment from 0 to 1000 V AC and from 0 to 1500 V DC.

This specifies that compliance with the requirements that it sets out is acquired if the equipment conforms to the standards harmonized on an European level. EN 60947-1 and EN 60947-4-1 for contactors.

- **Machinery Directive** 2006/42/EC for safety specifications of machines and equipment on complete machines.
- **Electromagnetic Compatibility Directive** 2004/108/EC which concerns all devices able to create electromagnetic disturbance.

### CE Marking:

CE marking indicates that the marked equipment conforms to the relevant EU directive.

CE marking is part of an administrative procedure and guarantees free movement of the product within the European Community.

### Standards in Canada and the USA

Canadian and American specifications are more or less equivalent but differ greatly from IEC standards.

**UL** Underwriters Laboratories USA

**CSA** Canadian Standard Association Canada

**UL** (USA) specifications make the following distinction between devices:



#### Listed Product

A product that has been produced under UL's listing and follow-up service program in accordance with the terms of UL's service agreement and that bears the UL listing mark as the manufacturer's declaration that the product complies with UL's requirements.



#### Recognized Component

A part or subassembly covered under UL's recognition service and intended for factory installation in listed (or other) products. Recognized components are incomplete in certain construction features or restricted in performance capabilities and not intended for separate installation in the field, rather they are intended for use as components of incomplete equipment submitted for investigation by UL. Final acceptance of the component in the complete equipment is dependent upon its installation and use in accordance with all applicable use conditions and ratings noted in the component report issued by UL, in the guide information and in the individual client's Recognized Component information page.

The combined UL signs for the USA and Canada are recognized by the authorities of both countries.

**Compulsory China Certification (CCC):** The CCC mark is a compulsory certification mark in the field of safety for products sold on the Chinese market.

**GOST:** Russia (please consult your local ABB sales office)

**C-Tick:** The C-Tick mark certifies compliance with the Australian EMC requirements. The mark is also recognized in New Zealand

**ANCE:** Mexico

### Marine Approvals

The following specifications must be respected when these devices are used on ships:

<b>BV</b>	Bureau Veritas France
<b>DNV</b>	Det Norske Veritas Norway
<b>GL</b>	Germanischer Lloyd Germany
<b>LRS</b>	Lloyd's Register of Shipping Great Britain
<b>ABS</b>	American Bureau of Shipping
<b>RMRS</b>	Russian Maritime Register of Shipping RMRS
<b>RRR</b>	Russian River Register
<b>MRS</b>	Maritime Register of Shipping Russia
<b>PRS</b>	Polski Rejestr Statkow Poland
<b>RINA</b>	Registro Italiano Navale Italy

# Standards, specifications and certifying organizations

## Specifications (cont.)

### International Standards

IEC 60947-1 Low-voltage switchgear and controlgear – Part 1: General rules

IEC 60947-4-1 Low-voltage switchgear and controlgear – Part 4: Contactors and motor starters – Section 1: Electromechanical contactors and motor starters

IEC 60947-5-1 Low-voltage switchgear and controlgear – Part 5: Control circuit devices and switching elements – Section 1: Electromechanical control circuit devices

IEC 60947-5-4 Low-voltage switchgear and controlgear – Part 5-4: Control circuit devices and switching elements. Method of assessing the performance of low-energy contacts. Special tests

IEC 60947-6-1 Low-voltage switchgear and controlgear – Part 6: Multiple function equipment – Section 1: Automatic transfer switching equipment

IEC 60204-1 Electrical equipment of industrial machines – Part 1: General requirements

IEC 60715 Dimensions of low-voltage switchgear and controlgear. Standardized mounting on rails for mechanical support of electrical devices in switchgear and controlgear installations

### European Standards

EN 50 005 Low-voltage switchgear and controlgear for industrial use – Terminal marking and distinctive number: General rules (Annex L of IEC 60947-1).

EN 50 011 Low-voltage switchgear and controlgear for industrial use – Terminal marking, distinctive number and distinctive letter for particular contactor relays (Annex M of IEC 60947-5-1)

EN 60947-1 Low-voltage switchgear and controlgear – Part 1: General rules.

EN 60947-4-1 Low-voltage switchgear and controlgear – Part 4: Contactors and motor starters – Section 1: Electromechanical contactors and motor starters.

EN 60947-5-1 Low-voltage switchgear and controlgear – Part 5: Control circuit devices and switching elements – Section 1: Electromechanical control circuit devices.

EN 60947-5-4 Low-voltage switchgear and controlgear – Part 5-4: Control circuit devices and switching elements. Method of assessing the performance of low-energy contacts. Special tests.

EN 60947-6-1 Low-voltage switchgear and controlgear – Part 6: Multiple function equipment – Section 1: Automatic transfer switching equipment.

EN 60204-1 Electrical equipment of industrial machines – Part 1: General requirements.

EN 60 715 Dimensions of low-voltage switchgear and controlgear. Standardized mounting on rails for mechanical support of electrical devices in switchgear and controlgear installations.

### National Standards

European countries national standards reproduce the corresponding EN... standards. Codification is built by addition of a prefix to EN numbering.

For instance:

- France **NF** EN...
- Germany **DIN** EN...
- Great Britain **BS** EN...
- Italy **CEI** EN...
- Sweden **SS** EN...

# Terms and technical definitions

## Circuits

- auxiliary circuit: All the conductive parts of a contactor designed to be inserted in a different circuit from the main circuit and the contactor control circuits.
- control circuit: All the conductive parts of a contactor (other than the main circuit and the auxiliary circuit) used to control the contactor's closing operation or opening operation or both.
- main circuit: All the conductive parts of a contactor designed to be inserted in the circuit that it controls.

## Thermal overload relay tripping classes

IEC 60947-4-1 defines tripping classes 10 A, 10, 20 and 30. Types 10 A, 10, etc. correspond to the maximum tripping time for a making current at 7.2 times the setting current.

4

Furthermore, for each class the standard specifies the tripping time for 1.5 times the setting current and sets the non tripping condition at 1.05 times the setting current.

All these data are summarized in the table below.

### Extract from IEC 60947-4-1:

Tripping class	10 A	10	20	30
Max. tripping time for 1.5 times the setting current (warm state)	s 120	240	480	720
Tripping time for 7.2 times the setting current (cold state)	s 2 - 10	4 - 10	6 - 20	9 - 30
For 1.05 times the setting current	No tripping			

## Electromagnetic compatibility

AF... contactors comply with IEC 60947-1, 60947-4-1 and EN 60947-1, 60947-4-1 standards.

Definitions:

Environment A: "Mainly relates to low-voltage non public or industrial networks/locations/installations (EN 50082-2 article 4) including highly disturbing sources".

Environment B: "Mainly relates to low-voltage public networks (EN 50082-1 article 5) such as residential, commercial and light industrial locations/installations. Highly disturbing sources such as arc welders are not covered by this environment".

Notice for AF09 ... AF38, AF116 ... AF2650 contactors and NF contactor relays: these products have been designed for environment A. Use of this product in environment B may cause unwanted electromagnetic disturbances in which case the user may be required to take adequate mitigation measures.

AF40 ... AF96 have been designed for environment B.

## Definitions according to SEMI F47-0706

SEMI F47-0706 defines the voltage sag immunity required for semiconductor processing, metrology and automated test equipment, and on subsystems and components which are used in the construction of semiconductor processing equipment including but not limited to:

- Power supplies
- Generators
- Robots and factory interface
- Chillers, pumps, blowers
- AC operated contactors and contactor relays
- ...

**voltage sag:** an rms reduction in the AC voltage, at the power frequency, for durations from a half cycle to a few seconds.

The IEC terminology for this phenomenon is voltage dip.

**voltage sag immunity:** the ability of equipment to withstand momentary electrical power interruptions or sags

## Coordination of protections against short circuit

The goal here is to protect electromechanical starters and softstarters.

Any starter is designed to:

- start motors,
- ensure continuous functioning of motors,
- disconnect motors from the supply line,
- guarantee protection of motors against overloads.

The starter is typically made up of a switching device (contactor) and an overload protection device (thermal overload relay or electronic overload relay). These two devices **MUST** be coordinated with equipment capable of providing protection against short circuit (SCPD: short circuit protective device): typically a circuit breaker with magnetic release only or a switch fuse. These are not necessarily part of the starter.

The characteristics of the starter must comply with the international standard IEC 60947-4-1 which defines the above items as follows:

**contactor:** a mechanical switching device having only one position of rest, operated otherwise than by hand, capable of making, carrying and breaking currents under normal circuit conditions including overload conditions.

**overload release:** overload relay or release which operates in the case of overload and also in case of loss of phase.

**circuit-breaker:** defined by IEC 60947-2 as a mechanical switching device, capable of making, carrying and breaking currents under normal circuit conditions and also making, carrying for a specified time and breaking currents under specified abnormal circuit conditions.

IEC publication 60947-4-1 defines coordination types "1" and "2":

- Type "1" coordination requires that, in the event of a short-circuit, the contactor or starter does not endanger persons or installations and will not then be able to operate without being repaired or parts being replaced.
- Type "2" coordination requires that, in short-circuit conditions, the contactor or starter does not endanger persons or installations and will be able to operate afterwards. The risk of contacts being light welded is acceptable. In this case, the manufacturer must stipulate the measures to be taken with respect to maintenance of the equipment.

## Rated operational current I<sub>e</sub>

Current rated by the manufacturer. It is mainly based on the rated operational voltage U<sub>e</sub>, the rated frequency, the utilization category, the rated duty and the type of protective enclosure, if necessary.

## Conventional free air thermal current I<sub>th</sub>

Current that the contactor can withstand in free air for a duty time of 8 hours without the temperature rise of its various parts exceeding the maximum values given by the standard.

## Operating cycle or cycle

Includes one making operation and one breaking operation.

## Cycle time

This is the sum of the current flow time and the no-current time for given cycle.

## Electrical durability

Number of on-load operating cycles that the contactor is able to carry out. It depends on the operational current, the operational voltage and the utilization category.

# Terms and technical definitions

## Mechanical durability

Number of no-current operating cycles that a contactor is able to carry out.

## Assessed failure rate

Defined according to IEC 60947-5-4. This rate is given in standard industrial environments for the contactor relays and for the built-in auxiliary contact of contactors.

## Load factor

Ratio of the on-load operating time to the total cycle time x 100.

## Switching frequency

Number of switching cycles per hour.

## Plugging

Stopping or fast reversal in rotation direction of a motor by two supply leads being interchanged while the motor is running.

## Inching

Energization of a motor's circuit repeatedly or for short periods with the aim of obtaining small movements of the driven mechanism.

## Coil operating limits

Expressed in multiples of the nominal control circuit voltage  $U_c$  for the upper and lower limits.

## Mounting position

Comply with the manufacturer's instructions. Restrictions are to be taken into account for certain mounting positions.

## Rated breaking or making capacity

Root mean square (r.m.s.) value of the current that the contactor is able to break or make at a given voltage according to the conditions specified by standards and for a given utilization category.

## Intermittent duty

Duty during which the contactor is successively closed or open for periods which are too short to enable the contactor to achieve thermal balance.

## Ambient temperature

Air temperature close to the contactor.

## Time

- Time constant: Ratio of the inductance to the resistance ( $L/R = \text{mH}/\Omega = \text{ms}$ ).
- Short-time withstand current: Current that the contactor is able to withstand in closed position for a short time interval and in specified conditions.
- Closing time: Time interval between the coil energization and the instant the contacts touch on all the poles.
- Opening time: Time interval between the coil de-energization and the instant the contacts separate on all the poles.

## Rated control voltage $U_c$

Control voltage value for which the control circuit is sized.

## Rated operational voltage $U_e$

Voltage to which the contactor's utilization characteristics refer. In three-phase it is the phase-to-phase voltage.

## Rated insulation voltage $U_i$

Reference voltage for dielectric tests and creepage distances.

## Rated impulse withstand voltage $U_{imp}$

Peak value of an impulse voltage, having a specified form and polarity, which does not cause breakdown in specific test conditions.

## Shock withstand

Requirement for vehicles, crane drives, installations on board ships and plug-in equipment. For the acceptable "g" values, the contacts must not change position and the thermal overload relays must not trip.

## Resistance to vibrations

Requirements for vehicles, boats and other means of transport. For the specified vibration amplitude and frequency values the device must remain able to operate.

# Standards and utilization categories

## Utilization categories:

A contactor's duty is characterized by the utilization category together with the rated operational voltage and current indicated.

### Utilization categories for contactors according to IEC 60947-4-1:

Alternating current:	AC-1	Non-inductive or slightly inductive loads, resistance furnaces.
	AC-2	Slip-ring motors: starting, switching off.
	AC-3	Cage motors: starting, switching off running motors.
	AC-4	Cage motors: starting, plugging, inching.
	AC-5a	Discharge lamp switching.
	AC-5b	Incandescent lamp switching.
	AC-6a	Transformer switching.
	AC-6b	Capacitor bank switching.
Direct current:	AC-8a	Hermetic refrigeration compressor motor control with manual resetting of overload releases.
	AC-8b	Hermetic refrigeration compressor motor control with automatic resetting of overload releases.
	DC-1	Non inductive or slightly inductive loads, resistance furnaces.
	DC-3	Shunt motors: starting, plugging, inching, dynamic breaking of DC motors.
	DC-5	Series motors: starting, plugging, inching, dynamic breaking of DC motors.
	DC-6	Incandescent lamp switching.

### Utilization categories for contactor relays according to IEC 60947-5-1:

Alternating current:	AC-12	Control of resistive loads and static loads with opto-coupler isolation.
	AC-13	Control of static loads with transformer isolation.
	AC-14	Control of weak electromagnetic loads ( $\leq 72$ VA).
	AC-15	Control of electromagnetic loads ( $> 72$ VA).
Direct current:	DC-12	Control of resistive loads and static loads with opto-coupler isolation.
	DC-13	Control of DC electromagnets.
	DC-14	Control of DC electromagnets having economy resistors.

In fact some applications, and the specific criteria characterizing the various loads controlled by contactors, may modify the utilization characteristics of the contactors. The main applications concerned are:

### Capacitor bank switching

Account must be taken of high peaks when the current is made and of harmonic currents during continuous duty. For this application, IEC publication 60947-4-1 stipulates utilization category AC-6b. The operational currents or powers acceptable for the contactors are determined by our electrical tests; IEC publication 60947-4-1 gives the calculating formula for determining the operational current (Table 9).

### Transformer switching

Account must be taken of the peaks due to magnetization phenomena when the current is made.

For this application, IEC publication 60947-4-1 stipulates utilization category AC-6a. The operational currents or powers acceptable for the contactors are determined using the values obtained for AC-3 or AC-4 category tests and the calculating formula given in IEC 60947-4-1 (Table 9).

### Lighting circuit switching

The current peaks occurring on energization of the circuit and the power factor depend on the type of lamps, the connection mode and whether or not there is compensation.

For this application, IEC publication 60947-4-1 stipulates two standard utilization categories:

- AC-5a for discharge lamp switching.
- AC-5b for incandescent lamp switching.

### Slip-ring motor switching

The contactors used for short-circuiting rotor resistors can be used for rotor voltages up to 2 times the rated operational voltage.

The conditions of use of rotor contactors depend on the connection mode of the main poles. IEC 60947-4-1 stipulates AC-2 utilization category for startor contactor.

# Standards and utilization categories

## Utilization categories (cont.)

### DC power circuit switching

Arc suppression is more difficult in direct current than in alternating current. Higher the time constant and voltage, heavier the breaking conditions: consequently several poles have to be connected in series.

### AC high current circuit switching

Possibility of increasing performances by connecting poles in parallel.

### Circuit switching during temporary and intermittent duty

In these cases higher operational currents are acceptable.

### Influence of the length of the conductors used in the contactor control circuit

According to the operational voltages, the cross-sectional areas, the coil consumption and the control layout, difficulties due to line resistances and capacitances may appear during contactor closing and opening orders.

## Making and breaking conditions for utilization categories

Utilization category	Durability test conditions						Occasional operation Making and breaking capacities - 50 operating cycles					
	Making conditions			Breaking conditions			Making conditions			Breaking conditions		
	I/le	U/Ur	Cos. $\theta$ or L/R (ms)	I/le	U/Ur	Cos. $\theta$ or L/R (ms)	Ic/le	Ur/Ur	Cos. $\theta$ or L/R (ms)	Ic/le	Ur/Ur	Cos. $\theta$ or L/R (ms)

### Contactors for AC circuit switching

AC-1		1	1	0.95	1	1	0.95	1.5	1.05	0.8	1.5	1.05	0.8
AC-2		2.5	1	0.65	2.5	1	0.65	4	1.05	0.65	4	1.05	0.65
AC-3	le < 17 A	6	1	0.65	1	0.17	0.65	10	1.05	0.45	8	1.05	0.45
	17 < le < 100 A	6	1	0.35	1	0.17	0.35	10	1.05	0.45	8	1.05	0.45
	le > 100 A	6	1	0.35	1	0.17	0.35	10	1.05	0.35	8	1.05	0.35
AC-4	le < 17 A	6	1	0.65	6	1	0.65	12	1.05	0.45	10	1.05	0.45
	17 < le < 100 A	6	1	0.35	6	1	0.35	12	1.05	0.45	10	1.05	0.45
	le > 100 A	6	1	0.35	6	1	0.35	12	1.05	0.35	10	1.05	0.35

### Contactors for DC circuit switching

DC-1		1	1	1	1	1	1	1.5	1.05	1	1.5	1.05	1
DC-3		2.5	1	2	2.5	1	2	4	1.05	2.5	4	1.05	2.5
DC-5		2.5	1	7.5	2.5	1	7.5	4	1.05	15	4	1.05	15

### Contactors for AC circuit switching

AC-14	( $\leq 72$ VA)	-	-	-	-	-	-	6	1.1	0.7	6	1.1	0.7
AC-15	(> 72 VA)	10	1	0.7	1	1	0.4	10	1.1	0.3	10	1.1	0.3

### Contactors for AC circuit switching

Utilization category	Standard operation						Occasional operation Making and breaking capacities - 50 operating cycles					
	Making conditions			Breaking conditions			Making conditions			Breaking conditions		
	I/le	U/Ur	$T_{0.95}$	I/le	U/Ur	$T_{0.95}$	Ic/le	Ur/Ur	$T_{0.95}$	Ic/le	Ur/Ur	$T_{0.95}$
DC-13	1	1	6 P(1)	1	1	6 P(1)	1.1	1.1	6 P(1)	1.1	1.1	6 P(1)
DC-14	-	-	-	-	-	-	10	1.1	15 ms	10	1.1	15 ms

(1) The value "6 x P" is the result of an empirical relation which is estimated to represent most DC magnetic loads up to the highest limit of P = 50 W (6 x P = 300 ms). It is accepted that loads having drawn energy above 50 W are made up of weaker loads in parallel. As a consequence, the 300 ms value must form the highest limit whatever the value of the power drawn.

### Key:

U (I) = applied voltage (current)

Ur = recovery voltage

L/R = test circuit time constant

Ue (Ie) = rated operational voltage (current)

Ic = making and breaking current expressed in DC or in AC like the r.m.s. value of the symmetrical components

$T_{0.95}$  = time required to reach 95% of the current in steady-state conditions, expressed in milliseconds

# Degrees of protection

## General

In an installation, the degree of protection required for electrical equipment depends on the environmental characteristics. The degree of protection, ensured by the enclosure of equipment or by the cubicle containing the equipment is expressed by the IP code which gives the level of protection against access to hazardous parts, the ingress of foreign bodies and/or the ingress of water, in compliance with IEC 60529, IEC 60947-1. Besides the IP symbol, the complete code has two figures followed (optionally) by two additional letters. A short description of the elements used in IP coding is given below.

IP... code	Figures or letters	Specifications for installation protection	Protection of persons
<b>First figure</b>		<b>Against ingress of foreign bodies</b>	<b>Against access to hazardous parts with:</b>
	0	No protection	No protection
	1	Diameter > 50 mm	Back of hand
	2	Diameter > 12.5 mm	Finger
	3	Diameter > 2.5 mm	Tool
	4	Diameter > 1 mm	Wire
	5	Limited protection against dust	Wire
	6	Total protection against dust	Wire
<b>Second figure</b>		<b>Against entrance of water having a harmful effect</b>	
	0	No protection	
	1	Vertical dripping	
	2	Dripping at a vertical angle of < 15°	
	3	Rain at a vertical angle of < 60°	
	4	Splashing	
	5	Low pressure water jet	
	6	Powerful water jets	
	7	Temporary immersion	
	8	Permanent immersion	
<b>Additional letter (optional) for use with:</b>		<b>Against ingress of foreign bodies</b>	<b>Against access to hazardous parts with:</b>
First figure 0	A	Stopped by a barrier with a 50 mm Ø sphere	Back of hand
First figure 0 or 1	B	Entrance of test finger limited to 80 mm	Finger
First figure 1 or 2	C	Wire with 2.5 mm Ø and length of 100 mm	Tool
First figure 2 or 3	D	Wire with 1 mm Ø and length of 100 mm	Wire
<b>Additional letter (optional)</b>		<b>Specific additional information</b>	
	H	High voltage apparatus	–
	M	Moving parts which are moving during water test	
	S	Moving parts which are stationary during water test	
	W	Specified atmospheric conditions	

Note: The type of enclosure or cubicle in which the equipment must be installed prevails with respect to the degree of protection.



# Climatic withstand of devices

The life time of devices are mainly influenced by series of climatic factors which cause their corrosion.

In practice, besides climatic conditions, there are other factors which may damage equipment such as fungi, insects (termites), dust, work site dirt and aggressive environment (salty or sulphurous atmosphere, etc.) which can often only be identified at the place of installation.

Climatic stress, definitions and test conditions are dealt with in national publications such as the DIN 50 series and UTE 63-100 publication which are attached to international publications such as IEC 60068.

## The test conditions are:

Description	Symbolization	Time of one cycle	Cycle phase time	Temperature in test chamber	Relative humidity
Humidity and variable temperature	IEC 60068-2-30 Test Db	24 hours	12 hours including rise in temperature	40 °C	95 %
			12 hours including cooling (open device)	25 °C	95 %

4

ABB contactors have been used for many years in the most countries, with hot and humid climates for example: Brazil, Indonesia, India or on ships. Experience has shown that ABB devices can be used in most countries throughout the world.

The climate of the country in which the apparatus is installed is not the determining choice factor.

## Account must be taken of:

- the immediate environment of the devices (sheltered, ventilated, temperature),
- the aggressivity of the immediate atmosphere at the place of installation,
- the length and frequency of non operating periods.

In the case of frequent condensation (i.e. the formation of condensation caused by rapid changes in temperature), heating resistors must be installed in cubicles (100 to 250 W per m<sup>3</sup> of enclosure).

## The table below gives the cases where heating is necessary.

Environment		Operating conditions	Climate	Internal heating of enclosure
Inside premises	No running water no condensation	Continuous or not	All climates	Without
	With running water	Continuous	All climates	Without
		Frequent or long stops	Temperate Tropical	Without With
Outside, sheltered	No running water no condensation	Continuous or not	Temperate	Without
			Tropical	With
Outside or by the seaside	With running water	Continuous	All climates	Without
			Frequent or long stops	Temperate Tropical

The entrance of dust, insects, dirt, etc. in devices may be prevented if the appropriate degree of protection according to IEC 60529 is chosen (See "Degree of protection" table).

# Electrical cross-reference

## AF Range vs. A Line

### UL / CSA



Contactor	AC general use [A]				AC motor ratings, break all lines, 50/60 Hz							UL file / vol. / sec.	CSA file
	300V	600V	600V (1)	1000V	Max. FLA	1 phase [hp]		3 phase [hp]					
						110-120V	220-240V	200-208V	220-240V	440-480V	550-600V		
<b>AF Range, 3 pole contactors</b>													
AF09/Z-30..	25	25	—	—	9	0.75	1.5	2	2	5	7.5	E312527/7/1	cULus
AF12/Z-30..	28	28	—	—	11	1	2	3	3	7.5	10	E312527/7/1	cULus
AF16/Z-30..	30	30	—	—	17.5	1.5	3	5	5	10	15	E312527/7/1	cULus
AF26/Z-30..	45	45	—	—	25.3	2	3	7.5	7.5	15	20	E312527/7/1	cULus
AF30/Z-30..	50	50	—	—	32.2	2	5	10	10	20	25	E312527/7/1	cULus
AF38/Z-30..	50	50	—	—	Use AF30 for UL / CSA motor applications.						E312527/7/1	cULus	
AF40-30..	60	60	—	—	42	3	7.5	10	15	30	40	E312527/14/1	cULus
AF52-30..	80	80	—	—	54	3	10	15	20	40	50	E312527/14/1	cULus
AF65-30..	90	90	—	—	68	5	15	20	25	50	60	E312527/14/1	cULus
AF80-30..	105	105	—	—	80	7.5	15	25	30	60	75	E312527/14/1	cULus
AF96-30..	115	115	—	—	92	7.5	20	30	30	60	75	E312527/14/1	cULus
AF116-30..	160	160	—	—	104	—	—	30	40	75	100	E36588/9/101	cULus
AF140-30..	200	200	—	—	130	—	—	40	50	100	125	E36588/9/101	cULus
AF146-30..	200	200	—	—	130	—	—	40	50	100	125	E36588/9/101	cULus
AF190-30..	230	230	250	—	156	—	—	50	60	125	150	E36588/9/102	cULus
AF205-30..	250	250	300	—	192	—	—	60	75	150	200	E36588/9/102	cULus
AF265-30..	300	300	350	—	248	—	—	75	100	200	250	E36588/9/103	cULus
AF305-30..	350	350	400	—	312	—	—	100	125	250	300	E36588/9/103	cULus
AF370-30..	400	400	520	—	361	—	—	125	150	300	350	E36588/9/103	cULus
AF400-30..	550	550	—	—	414	—	—	125	150	350	400	E36588/6/4	cULus
AF460-30..	650	650	—	—	480	—	—	150	200	400	500	E36588/6/4	cULus
AF580-30..	750	750	—	—	604	—	—	200	250	500	600	E36588/6/5	cULus
AF750-30..	900	900	—	—	722	—	—	250	300	600	700	E36588/6/5	cULus
AF1250-30..	1210	1210	—	—	—	—	—	—	—	—	—	E73397/2/11	cULus
AF1350-30..	1350	1350	—	—	954	—	—	—	400	800	1000	E36588/6/6	cULus
AF1650-30..	1650	1650	—	—	1050	—	—	—	450	900	1150	E36588/6/6	cULus
AF2050-30..	2100	2100	—	—	—	—	—	—	—	—	—	E73397/2/12	cULus
AF2650-30..	2700	2700	—	2700	—	—	—	—	—	—	—	E73397/2/15	cULus

<b>A Line, 3 pole contactors</b>													
A/E9-30..	21	21	—	—	9	0.5	2	2	2	5	7.5	E312527/10/2	LR56745
A/E12-30..	25	25	—	—	11	0.75	2	3	3	7.5	10	E312527/10/2	LR56745
A/E16-30..	30	30	—	—	17	2	3	5	5	10	15	E312527/10/2	LR56745
A/E26-30..	40	40	—	—	28	2	5	7.5	10	20	25	E312527/10/3	LR56745
A/E30-30..	50	50	—	—	34	3	7.5	10	10	25	30	E312527/10/4	LR56745
A/E40-30..	60	60	—	—	42	3	7.5	10	15	30	40	E312527/10/4	LR56745
A/E/F50-30..	80	80	—	—	54	3	7.5	15	20	40	50	E312527/10/1	LR56745
A/E/F63-30..	90	90	—	—	68	5	10	20	25	50	60	E312527/10/1	LR56745
A/E/F75-30..	105	105	—	—	80	7.5	15	25	30	60	75	E312527/10/1	LR56745
A/F95-30..	125	125	—	—	88	7.5	20	30	30	60	75	E36588/6/1	cULus
A/F110-30..	150	150	—	—	104	10	25	30	40	75	100	E36588/6/1	cULus
A/F145-30..	230	230	—	—	130	—	—	40	50	100	125	E36588/6/2	cULus
A/F185-30..	250	250	—	—	156	—	—	50	60	125	150	E36588/6/2	cULus
A/F210-30..	300	300	—	—	192	—	—	60	75	150	200	E36588/6/3	cULus
A/F260-30..	350	350	—	—	248	—	—	75	100	200	250	E36588/6/3	cULus
A/F300-30..	400	400	—	—	302	—	—	100	100	250	300	E36588/6/3	cULus

(1) When used with LX.. terminal extension.

# Electrical cross-reference

## AF Range vs. A Line

### IEC / NEMA



Controller	Utilization category AC-1, 40°C, Ie [A]			Utilization Category AC-3, 55°C, 50/60 Hz								AC motor ratings, Class A controllers, break all lines						
	440V	690V	1000V	AC-3 Ie [A]	Rated operational power 3 phase [kW]						NEMA size	Continuous [A]	1 phase [hp]		3 phase [hp]			
					230V	380V 400V	415V	440V	500V	690V			1000V	115V	230V	200V	230V	460V 575V
<b>AF Range, 3 pole contactors</b>																		
AF09/Z-30..	25	25	—	9	2.2	4	4	4	5.5	5.5	—	00	9	0.33	1	1.5	1.5	2
AF12/Z-30..	28	28	—	12	3	5.5	5.5	5.5	7.5	7.5	—	0	18	1	2	3	3	5
AF16/Z-30..	30	30	—	18	4	7.5	9	9	9	9	—	—	—	—	—	—	—	—
AF26/Z-30..	45	45	—	26	6.5	11	11	15	15	15	—	1	27	2	3	7.5	7.5	10
AF30/Z-30..	50	50	—	32	9	15	15	18.5	18.5	18.5	—	—	—	—	—	—	—	—
AF38/Z-30..	50	50	—	38	11	18.5	18.5	22	22	22	—	—	—	—	—	—	—	—
AF40-30..	70	70	—	40	11	18.5	22	22	22	22	—	2	45	3	7.5	10	15	25
AF52-30..	100	100	—	53	15	22	30	30	30	30	—	—	—	—	—	—	—	—
AF65-30..	105	105	—	65	18.5	30	37	37	37	37	—	—	—	—	—	—	—	—
AF80-30..	125	125	—	80	22	37	45	45	45	45	—	3	90	—	—	25	30	50
AF96-30..	130	130	—	96	25	45	55	55	55	55	—	—	—	—	—	—	—	—
AF116-30..	160	160	—	116	30	55	55	75	75	55	—	—	—	—	—	—	—	—
AF140-30..	200	200	—	140	37	75	75	90	90	75	—	4	135	—	—	40	50	100
AF146-30..	225	225	225	146	45	75	75	90	90	90	75	—	—	—	—	—	—	—
AF190-30..	275	275	250	190	55	90	90	110	110	132	110	—	—	—	—	—	—	—
AF205-30..	350	350	275	205	55	110	110	132	132	160	132	—	—	—	—	—	—	—
AF265-30..	400	400	350	265	75	132	132	160	160	200	132	5	270	—	—	75	100	200
AF305-30..	500	500	375	305	90	160	160	160	200	250	132	—	—	—	—	—	—	—
AF370-30..	600	600	400	370	110	200	200	200	250	315	132	—	—	—	—	—	—	—
AF400-30..	600	600	600	400	110	200	220	220	250	315	220	—	—	—	—	—	—	—
AF460-30..	700	700	700	460	132	250	250	250	315	355	280	6	540	—	—	150	200	400
AF580-30..	800	800	800	580	160	315	355	355	400	500	355	—	—	—	—	—	—	—
AF750-30..	1050	1050	1000	750	220	400	425	450	520	600	400	7	810	—	—	—	300	600
AF1250-30..	1260	1260	1260	—	—	—	—	—	—	—	—	—	—	—	—	—	—	—
AF1350-30..	1350	1350	1350	860	257	475	500	560	560	750	—	—	—	—	—	—	—	—
AF1650-30..	1650	1650	1650	1050	315	560	600	670	700	900	—	8	1215	—	—	—	450	900
AF2050-30..	2050	2050	2050	—	—	—	—	—	—	—	—	—	—	—	—	—	—	—
AF2650-30..	2650	2650	2650	—	—	—	—	—	—	—	—	—	—	—	—	—	—	—

<b>A Line, 3 pole contactors</b>																		
A/E9-30..	25	25	—	9	2.2	4	4	4	5.5	5.5	—	00	9	0.33	1	1.5	1.5	2
A/E12-30..	27	27	—	12	3	5.5	5.5	5.5	7.5	7.5	—	—	—	—	—	—	—	—
A/E16-30..	30	30	—	17	4	7.5	9	9	9	9	—	0	18	1	2	3	3	5
A/E26-30..	45	45	—	26	6.5	11	11	15	15	15	—	1	27	2	3	7.5	7.5	10
A/E30-30..	55	55	—	32	9	15	15	18.5	18.5	18.5	—	—	—	—	—	—	—	—
A/E40-30..	60	60	—	37	11	18.5	18.5	22	22	22	—	—	—	—	—	—	—	—
A/E/F50-30..	100	100	—	50	15	22	25	25	30	30	—	2	45	3	7.5	10	15	25
A/E/F63-30..	115	115	—	65	18.5	30	37	37	37	37	—	—	—	—	—	—	—	—
A/E/F75-30..	125	125	—	75	22	37	40	40	45	40	—	3	90	—	—	25	30	50
A/F95-30..	145	145	—	96	25	45	55	55	55	55	40	—	—	—	—	—	—	—
A/F110-30..	160	160	—	110	30	55	59	59	59	75	40	—	—	—	—	—	—	—
A/F145-30..	250	250	180	145	45	75	75	75	90	110	110	4	135	—	—	40	50	100
A/F185-30..	275	275	200	185	55	90	90	90	110	132	132	—	—	—	—	—	—	—
A/F210-30..	350	350	—	210	59	110	110	110	132	160	—	—	—	—	—	—	—	—
A/F260-30..	400	400	—	260	80	140	140	140	180	200	—	5	270	—	—	75	100	200
A/F300-30..	500	500	—	305	90	160	160	160	200	250	—	—	—	—	—	—	—	—

# North American HVAC applications

## General

AF Range contactors can be used for North American HVAC applications, controlling loads such as resistive heaters and refrigerant compressor motors. The cycling endurance required for controllers in these applications is typically higher than those for squirrel cage motors.

This testing has been performed in accordance with UL 60947-4-1A and CSA C22.2 No. 60947-4-1A, 1st edition.

## Ordering details

UL / CSA						Catalog number (1)	Global reference code (1)	cULus	
Resistance air heating, 3-phase 600 V	Definite purpose ratings for use with hermetic refrigeration compressors, 3-phase, utilization category AC-8a								
A	Full load Amps	200-208V	220-240V	440-480V	550-600V				
	FLA	LRA	LRA	LRA	LRA				
<b>3-pole non-reversing contactors</b>									
20	20	120	120	120	80	AF09-30-10-13	1SBL137001R1310	E312527	
25	25	150	150	150	100	AF12-30-10-13	1SBL157001R1310	E312527	
30	30	180	180	180	120	AF16-30-10-13	1SBL177001R1310	E312527	
45	35	210	210	210	140	AF26-30-00-13	1SBL237001R1300	E312527	
50	40	240	240	240	160	AF30-30-00-13	1SBL277001R1300	E312527	
50	45	270	270	270	180	AF38-30-00-13	1SBL297001R1300	E312527	
65						AF40-30-11-13	1SBL347001R1311	E312527	
80						AF52-30-11-13	1SBL367001R1311	E312527	
90		Planned testing.					AF65-30-11-13	1SBL387001R1311	E312527
105						AF80-30-11-13	1SBL397001R1311	E312527	
115						AF96-30-11-13	1SBL407001R1311	E312527	
—	116	800	800	800	800	AF116-30-11-13	1SFL427001R1311	E36588	
—	125	875	875	875	875	AF140-30-11-13	1SFL447001R1311	E36588	
—	160	1050	1050	1050	1050	AF146-30-11-13	1SFL467001R1311	E36588	
—	200	1400	1400	1400	1400	AF190-30-11-13	1SFL487002R1311	E36588	
—	250	1500	1500	1500	1500	AF205-30-11-13	1SFL527002R1311	E36588	
—	300	2100	2100	2100	2100	AF265-30-11-13	1SFL547002R1311	E36588	
—	350	2450	2450	2450	2450	AF305-30-11-13	1SFL587002R1311	E36588	
—	520	3120	3120	3120	3120	AF370-30-11-13	1SFL607002R1311	E36588	
—	520	3120	3120	3120	3120	AF400-30-11-70	1SFL577001R7011	E36588	
—	650	3746	3746	3746	3746	AF460-30-11-70	1SFL597001R7011	E36588	
<b>4-pole non-reversing contactors</b>									
	20	120	120	120	80	AF09-40-00-13	1SBL137201R1300	E319322	
Planned testing.	30	180	180	180	120	AF16-40-00-13	1SBL177201R1300	E319322	
	—	—	—	—	—	AF26-40-00-13	1SBL237201R1300	E319322	
	—	—	—	—	—	AF38-40-00-13	1SBL297201R1300	E319322	

(1) Ratings representative of all auxiliary configurations and coil voltages, including low-consumption versions.

# CSA elevator applications

## General

AF Range contactors can be used for CSA elevator applications, controlling motors utilized in equipment designed to transport personnel. These devices have been tested under load to 500,000 electrical cycles at twice their rated nominal current.

This testing has been performed in accordance with CSA B44.1 / ASME 19.2.2

## Ordering details

Acc. CSA B44.1 / ASME 19.2.2						Catalog number (1)	Global reference code (1)	cULus
Elevator control, load switching, 500,000 cycles								
1-phase			3-phase					
110-120V	220-240V	200-208V	220-240V	440-480V	550-600V			
hp	hp	hp	hp	hp	hp			
<b>3-pole non-reversing contactors</b>								
0.25	0.5	1	1	3	3	AF09-30-10-13	1SBL137001R1310	E312527
0.33	0.75	2	2	5	5	AF12-30-10-13	1SBL157001R1310	E312527
Use 4-pole version						AF16-30-10-13	1SBL177001R1310	E312527
1.5	3	5	5	15	15	AF26-30-00-13	1SBL237001R1300	E312527
2	3	7.5	7.5	20	20	AF30-30-00-13	1SBL277001R1300	E312527
2	5	7.5	10	20	20	AF38-30-00-13	1SBL297001R1300	E312527
Planned testing.						AF40-30-11-13	1SBL347001R1311	E312527
						AF52-30-11-13	1SBL367001R1311	E312527
						AF65-30-11-13	1SBL387001R1311	E312527
						AF80-30-11-13	1SBL397001R1311	E312527
						AF96-30-11-13	1SBL407001R1311	E312527
<b>4-pole non-reversing contactors</b>								
0.5	1.5	3	3	7.5	10	AF16-40-00-13	1SBL177201R1300	E319322

(1) Ratings representative of all auxiliary configurations and coil voltages, including low-consumption versions.

# North American lighting applications

## General

AF Range contactors can be used for North American lighting applications, controlling the two basic types of lighting loads: Tungsten, or incandescent, and ballast, or fluorescent. These devices are rated for controlling single phase (one load per pole up to 347 V AC) and three phase loads up to 600 V AC.

This testing has been performed in accordance with UL 60947-4-1A and CSA C22.2 No. 60947-4-1A, 1st edition.

## Ordering details

UL/CSA				Catalog number (1)	Global reference code (1)	cULus
Tungsten lamps		Electrical discharge lamps (ballast)				
1-phase, per pole	3-phase, break all lines	1-phase, per pole	3-phase, break all lines			
347 V	600 V	347 V	600 V			
A	A	A	A			
<b>3-pole non-reversing contactors</b>						
		20	20	AF09-30-10-13	1SBL137001R1310	E312527
		25	25	AF12-30-10-13	1SBL157001R1310	E312527
		30	30	AF16-30-10-13	1SBL177001R1310	E312527
		45	45	AF26-30-00-13	1SBL237001R1300	E312527
		50	50	AF30-30-00-13	1SBL277001R1300	E312527
Planned testing.		50	50	AF38-30-00-13	1SBL297001R1300	E312527
		65	65	AF40-30-11-13	1SBL347001R1311	E312527
		80	80	AF52-30-11-13	1SBL367001R1311	E312527
		90	90	AF65-30-11-13	1SBL387001R1311	E312527
		105	105	AF80-30-11-13	1SBL397001R1311	E312527
		115	115	AF96-30-11-13	1SBL407001R1311	E312527
–	–			AF116-30-11-13	1SFL427001R1311	E36588
–	–			AF140-30-11-13	1SFL447001R1311	E36588
–	–			AF146-30-11-13	1SFL467001R1311	E36588
–	–		Planned testing.	AF190-30-11-13	1SFL487002R1311	E36588
–	–			AF205-30-11-13	1SFL527002R1311	E36588
–	–			AF265-30-11-13	1SFL547002R1311	E36588
–	–			AF305-30-11-13	1SFL587002R1311	E36588
–	–			AF370-30-11-13	1SFL607002R1311	E36588
<b>4-pole non-reversing contactors</b>						
				AF09-40-00-13	1SBL137201R1300	E319322
				AF09-22-00-13	1SBL137501R1300	E319322
				AF16-40-00-13	1SBL177201R1300	E319322
Planned testing.			Planned testing.	AF16-22-00-13	1SBL177501R1300	E319322
				AF26-40-00-13	1SBL237201R1300	E319322
				AF26-22-00-13	1SBL237501R1300	E319322
				AF38-40-00-13	1SBL297201R1300	E319322
				AF38-22-00-13	1SBL297501R1300	E319322

(1) Ratings representative of all auxiliary configurations and coil voltages, including low-consumption versions.

# Pilot duty and overload trip classes

## Pilot duty

Pilot duty is a rating assigned to a relay or switch that controls the coil of another relay or switch. This rating is applied to auxiliary devices utilized in the control circuit. Devices are typically marked with contact rating designations, first an AC value, and second a DC value (ie. A600, Q600). Charts like the ones below can be used to determine the maximum current and voltage that the device is suitable for.

### Pilot duty ratings for AC control circuits acc. UL 508, Table 139.1

Contact rating designation	Continuous thermal current	Maximum current								Volt-amperes	
		120 V AC		240 V AC		480 V AC		600 V AC		Make VA	Break VA
		Make	Break	Make	Break	Make	Break	Make	Break		
A	A	A	A	A	A	A	A	VA	VA		
A150	10	60	6	—	—	—	—	—	—	7200	720
A300	10	60	6	30	3	—	—	—	—	7200	720
A600	10	60	6	30	3	15	1.5	12	1.2	7200	720
B150	5	30	3	—	—	—	—	—	—	3600	360
B300	5	30	3	15	1.5	—	—	—	—	3600	360
B600	5	30	3	15	1.5	7.5	0.75	6	0.6	3600	360
C150	2.5	15	1.5	—	—	—	—	—	—	1800	180
C300	2.5	15	1.5	7.5	0.75	—	—	—	—	1800	180
C600	2.5	15	1.5	7.5	0.75	3.75	0.375	3	0.3	1800	180
D150	1	3.6	0.6	—	—	—	—	—	—	432	72
D300	1	3.6	0.6	1.8	0.3	—	—	—	—	432	72
E150	0.5	1.8	0.3	—	—	—	—	—	—	216	36

### Pilot duty ratings for DC control circuits acc. UL 508, Table 139.2

Contact rating designation	Continuous thermal current	Maximum current						Volt-amperes	
		120 V DC		250 V DC		600 V DC		Make VA	Break VA
		Make	Break	Make	Break	Make	Break		
A	A	A	A	A	A	A	VA	VA	
N150	10	2.2	2.2	—	—	—	—	275	275
N300	10	2.2	2.2	1.1	1.1	—	—	275	275
N600	10	2.2	2.2	1.1	1.1	0.4	0.4	275	275
P150	5	1.1	1.1	—	—	—	—	138	138
P300	5	1.1	1.1	0.55	0.55	—	—	138	138
P600	5	1.1	1.1	0.55	0.55	0.2	0.2	138	138
Q150	2.5	0.55	0.55	—	—	—	—	69	69
Q300	2.5	0.55	0.55	0.27	0.27	—	—	69	69
Q600	2.5	0.55	0.55	0.27	0.27	0.1	0.1	69	69
R150	1	0.22	0.22	—	—	—	—	28	28
R300	1	0.22	0.22	0.11	0.11	—	—	28	28
E150	0.5	1.8	0.3	—	—	—	—	216	36

## Overload trip classes

In addition to their current setting, overloads are also marked with a trip class. This class indicates the period of time that an overload will delay before normal tripping characteristics take effect. This delay is an important consideration based on the starting time of the motor.

### Overload trip classes acc. UL 60947-4-1A

Trip class	Tripping Time Tp (Seconds)
10A	2 < Tp ≤ 10
10	4 < Tp ≤ 10
20	6 < Tp ≤ 20
30	9 < Tp ≤ 30

# AF09 ... AF96 contactors

## DC circuit switching

### General

The arc switching on DC is more difficult than on AC.

For selecting a contactor it is essential to determine the current, the voltage and the L/R time constant of the controlled load

For information, typical time constant values are quoted hereafter: non inductive loads such as resistance furnaces ( $L/R \approx 1$  ms), inductive loads such as shunt motors ( $L/R \approx 2$  ms) or series motors ( $L/R \approx 7.5$  ms)

The addition of a resistor in parallel with an inductive winding helps in the elimination of the arcs

All the poles required for breaking must be connected in series between the load and the source polarity not linked to earth (or chassis).

### Technical data

The tables indicate for the standard contactors the  $I_e$  max. operating currents depending on: the utilization category (i.e. L/R) DC-1, DC-3, DC-5 as defined in the IEC 60947-4-1 publication, the operating voltage  $U_e$  and the pole coupling details.

Ampere values quoted in these tables are valid for a  $-25...+70$  °C temperature close to the contactors, as long as these values do not exceed the AC-1 Ampere values for the corresponding ambient temperature



4

Max. switching frequency: 300 cycles/h.



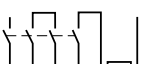

### Selection table

Contactor types	AF09	AF12	AF16	AF26	AF30	AF38	AF40	AF52	AF65	AF80	AF96
	3 or 4-pole			3-pole	4-pole	3-pole	3-pole	4-pole	3-pole	3-pole	3-pole



#### Utilization category DC-1, L/R ≤ 1 ms

	≤ 72 V	25 A	27 A	30 A	45 A	45 A	50 A	50 A	55 A	70 A	100 A	105 A	125 A	130 A
	110 V	10 A	15 A	20 A	-	-	-	-	-	-	-	-	-	-
	220 V	-	-	-	-	-	-	-	-	-	-	-	-	-
	≤ 72 V	25 A	27 A	30 A	45 A	45 A	50 A	50 A	55 A	70 A	100 A	105 A	125 A	130 A
	110 V	25 A	27 A	30 A	45 A	45 A	50 A	50 A	55 A	70 A	100 A	105 A	125 A	130 A
	220 V	10 A	15 A	20 A	-	-	-	-	-	-	-	-	-	-
	≤ 72 V	25 A	27 A	30 A	45 A	45 A	50 A	50 A	55 A	70 A	100 A	105 A	125 A	130 A
	110 V	25 A	27 A	30 A	45 A	45 A	50 A	50 A	55 A	70 A	100 A	105 A	125 A	130 A
	220 V	25 A	27 A	30 A	45 A	45 A	50 A	50 A	55 A	70 A	100 A	105 A	125 A	130 A
	≤ 72 V	25 A	-	30 A	-	45 A	-	-	55 A	-	-	-	-	-
	110 V	25 A	-	30 A	-	45 A	-	-	55 A	-	-	-	-	-
	220 V	25 A	-	30 A	-	45 A	-	-	55 A	-	-	-	-	-
	440 V	10 A	-	20 A	-	-	-	-	-	-	-	-	-	-

#### Utilization category DC-3, L/R ≤ 2 ms

	≤ 72 V	25 A	27 A	30 A	45 A	-	50 A	50 A	-	70 A	100 A	105 A	125 A	130 A
	110 V	6 A	7 A	8 A	-	-	-	-	-	-	-	-	-	-
	220 V	-	-	-	-	-	-	-	-	-	-	-	-	-
	≤ 72 V	25 A	27 A	30 A	45 A	-	50 A	50 A	-	70 A	100 A	105 A	125 A	130 A
	110 V	25 A	27 A	30 A	45 A	-	50 A	50 A	-	70 A	100 A	105 A	125 A	130 A
	220 V	6 A	7 A	8 A	-	-	-	-	-	-	-	-	-	-
	≤ 72 V	25 A	27 A	30 A	45 A	-	50 A	50 A	-	70 A	100 A	105 A	125 A	130 A
	110 V	25 A	27 A	30 A	45 A	-	50 A	50 A	-	70 A	100 A	105 A	125 A	130 A
	220 V	25 A	27 A	30 A	45 A	-	50 A	50 A	-	70 A	100 A	105 A	125 A	130 A
	≤ 72 V	25 A	-	30 A	-	-	-	-	-	-	-	-	-	-
	110 V	25 A	-	30 A	-	-	-	-	-	-	-	-	-	-
	220 V	25 A	-	30 A	-	-	-	-	-	-	-	-	-	-
	440 V	6 A	-	8 A	-	-	-	-	-	-	-	-	-	-

#### Utilization category DC-5, L/R ≤ 7.5 ms

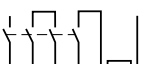
	≤ 72 V	9 A	12 A	16 A	20 A	-	25 A	25 A	-	70 A	100 A	105 A	125 A	130 A
	110 V	4 A	4 A	4 A	-	-	-	-	-	-	-	-	-	-
	220 V	-	-	-	-	-	-	-	-	-	-	-	-	-
	≤ 72 V	25 A	27 A	30 A	45 A	-	50 A	50 A	-	70 A	100 A	105 A	125 A	130 A
	110 V	10 A	15 A	20 A	45 A	-	50 A	50 A	-	70 A	100 A	105 A	125 A	130 A
	220 V	4 A	4 A	4 A	-	-	-	-	-	-	-	-	-	-
	≤ 72 V	25 A	27 A	30 A	45 A	-	50 A	50 A	-	70 A	100 A	105 A	125 A	130 A
	110 V	25 A	27 A	30 A	45 A	-	50 A	50 A	-	70 A	100 A	105 A	125 A	130 A
	220 V	9 A	12 A	16 A	20 A	-	25 A	25 A	-	70 A	100 A	105 A	125 A	130 A
	≤ 72 V	25 A	-	30 A	-	-	-	-	-	-	-	-	-	-
	110 V	25 A	-	30 A	-	-	-	-	-	-	-	-	-	-
	220 V	10 A	-	20 A	-	-	-	-	-	-	-	-	-	-
	440 V	4 A	-	4 A	-	-	-	-	-	-	-	-	-	-



# Catalog number alphanumeric

Catalog number	Page	Catalog number	Page	Catalog number	Page	Catalog number	Page
AF09-22-00-11	2.26	AF09N00Z-30-10-20	2.16	AF116R-30-22-11	2.12	AF12N0Z-30-10-22	2.16
AF09-22-00-12	2.26	AF09N00Z-30-10-21	2.16	AF116R-30-22-12	2.12	AF12N0Z-30-10-23	2.16
AF09-22-00-13	2.26	AF09N00Z-30-10-22	2.16	AF116R-30-22-13	2.12	AF12N0ZM-3022-21	2.22
AF09-22-00-14	2.26	AF09N00Z-30-10-23	2.16	AF116R-30-22-14	2.12	AF12N0ZM-3022-22	2.22
AF09-22-00-41	2.26	AF09N00ZM-3022-21	2.22	AF12-30-01-11	2.2	AF12N0ZM-3022-23	2.22
AF09-30-01-11	2.2	AF09N00ZM-3022-22	2.22	AF12-30-01-12	2.2	AF12N0ZR-3022-21	2.22
AF09-30-01-12	2.2	AF09N00ZM-3022-23	2.22	AF12-30-01-13	2.2	AF12N0ZR-3022-22	2.22
AF09-30-01-13	2.2	AF09N00ZR-3022-21	2.22	AF12-30-01-14	2.2	AF12N0ZR-3022-23	2.22
AF09-30-01-14	2.2	AF09N00ZR-3022-22	2.22	AF12-30-01-41	2.2	AF12R-30-22-11	2.9
AF09-30-01-41	2.2	AF09N00ZR-3022-23	2.22	AF12-30-10-11	2.2	AF12R-30-22-12	2.9
AF09-30-10-11	2.2	AF09R-30-22-11	2.9	AF12-30-10-12	2.2	AF12R-30-22-13	2.9
AF09-30-10-12	2.2	AF09R-30-22-12	2.9	AF12-30-10-13	2.2	AF12R-30-22-14	2.9
AF09-30-10-13	2.2	AF09R-30-22-13	2.9	AF12-30-10-14	2.2	AF12R-30-22-41	2.9
AF09-30-10-14	2.2	AF09R-30-22-14	2.9	AF12-30-10-41	2.2	AF12Z-30-01-20	2.3
AF09-30-10-41	2.2	AF09R-30-22-41	2.9	AF1250-30-11-68	2.8	AF12Z-30-01-21	2.3
AF09-40-00-11	2.26	AF09Z-22-00-20	2.27	AF1250-30-11-69	2.8	AF12Z-30-01-22	2.3
AF09-40-00-12	2.26	AF09Z-22-00-21	2.27	AF1250-30-11-70	2.8	AF12Z-30-01-23	2.3
AF09-40-00-13	2.26	AF09Z-22-00-22	2.27	AF1250-30-11-71	2.8	AF12Z-30-10-20	2.3
AF09-40-00-14	2.26	AF09Z-22-00-23	2.27	AF12M-30-22-11	2.9	AF12Z-30-10-21	2.3
AF09-40-00-41	2.26	AF09Z-30-01-20	2.3	AF12M-30-22-12	2.9	AF12Z-30-10-22	2.3
AF09M-30-22-11	2.9	AF09Z-30-01-21	2.3	AF12M-30-22-13	2.9	AF12Z-30-10-23	2.3
AF09M-30-22-12	2.9	AF09Z-30-01-22	2.3	AF12M-30-22-14	2.9	AF12ZM-30-22-21	2.10
AF09M-30-22-13	2.9	AF09Z-30-01-23	2.3	AF12M-30-22-41	2.9	AF12ZM-30-22-22	2.10
AF09M-30-22-14	2.9	AF09Z-30-10-20	2.3	AF12N0-30-01-11	2.15	AF12ZM-30-22-23	2.10
AF09M-30-22-41	2.9	AF09Z-30-10-21	2.3	AF12N0-30-01-12	2.15	AF12ZR-30-22-21	2.10
AF09N00-30-01-11	2.15	AF09Z-30-10-22	2.3	AF12N0-30-01-13	2.15	AF12ZR-30-22-22	2.10
AF09N00-30-01-12	2.15	AF09Z-30-10-23	2.3	AF12N0-30-01-14	2.15	AF12ZR-30-22-23	2.10
AF09N00-30-01-13	2.15	AF09Z-40-00-20	2.27	AF12N0-30-01-41	2.15	AF1350-30-11-70	2.8
AF09N00-30-01-14	2.15	AF09Z-40-00-21	2.27	AF12N0-30-10-11	2.15	AF140-30-11-11	2.5
AF09N00-30-01-41	2.15	AF09Z-40-00-22	2.27	AF12N0-30-10-12	2.15	AF140-30-11-12	2.5
AF09N00-30-10-11	2.15	AF09Z-40-00-23	2.27	AF12N0-30-10-13	2.15	AF140-30-11-13	2.5
AF09N00-30-10-12	2.15	AF09ZM-30-22-21	2.10	AF12N0-30-10-14	2.15	AF140-30-11-14	2.5
AF09N00-30-10-13	2.15	AF09ZM-30-22-22	2.10	AF12N0-30-10-41	2.15	AF140-30-11B-11	2.5
AF09N00-30-10-14	2.15	AF09ZM-30-22-23	2.10	AF12NOM-3022-11	2.21	AF140-30-11B-12	2.5
AF09N00-30-10-41	2.15	AF09ZR-30-22-21	2.10	AF12NOM-3022-12	2.21	AF140-30-11B-13	2.5
AF09N00M-3022-11	2.21	AF09ZR-30-22-22	2.10	AF12NOM-3022-13	2.21	AF140-30-11B-14	2.5
AF09N00M-3022-12	2.21	AF09ZR-30-22-23	2.10	AF12NOM-3022-14	2.21	AF140M-30-22-11	2.12
AF09N00M-3022-13	2.21	AF116-30-11-11	2.5	AF12NOM-3022-41	2.21	AF140M-30-22-12	2.12
AF09N00M-3022-14	2.21	AF116-30-11-12	2.5	AF12NOR-3022-11	2.21	AF140M-30-22-13	2.12
AF09N00M-3022-41	2.21	AF116-30-11-13	2.5	AF12NOR-3022-12	2.21	AF140M-30-22-14	2.12
AF09N00R-3022-11	2.21	AF116-30-11-14	2.5	AF12NOR-3022-13	2.21	AF140N4-30-11-11	2.18
AF09N00R-3022-12	2.21	AF116-30-11B-11	2.5	AF12NOR-3022-14	2.21	AF140N4-30-11-12	2.18
AF09N00R-3022-13	2.21	AF116-30-11B-12	2.5	AF12NOR-3022-41	2.21	AF140N4-30-11-13	2.18
AF09N00R-3022-14	2.21	AF116-30-11B-13	2.5	AF12N0Z-30-01-20	2.16	AF140N4-30-11-14	2.18
AF09N00R-3022-41	2.21	AF116-30-11B-14	2.5	AF12N0Z-30-01-21	2.16	AF140N4-30-11B-11	2.18
AF09N00Z-30-01-20	2.16	AF116M-30-22-11	2.12	AF12N0Z-30-01-22	2.16	AF140N4-30-11B-12	2.18
AF09N00Z-30-01-21	2.16	AF116M-30-22-12	2.12	AF12N0Z-30-01-23	2.16	AF140N4-30-11B-13	2.18
AF09N00Z-30-01-22	2.16	AF116M-30-22-13	2.12	AF12N0Z-30-10-20	2.16	AF140N4-30-11B-14	2.18
AF09N00Z-30-01-23	2.16	AF116M-30-22-14	2.12	AF12N0Z-30-10-21	2.16	AF140N4M-3022-11	2.24

# Catalog number alphanumeric

Catalog number	Page	Catalog number	Page	Catalog number	Page	Catalog number	Page
AF140N4M-3022-12	2.24	AF16R-30-22-14	2.9	AF26-22-00-11	2.26	AF26M-30-22-41	2.9
AF140N4M-3022-13	2.24	AF16R-30-22-41	2.9	AF26-22-00-12	2.26	AF26N1-30-00-11	2.15
AF140N4M-3022-14	2.24	AF16Z-22-00-20	2.27	AF26-22-00-13	2.26	AF26N1-30-00-12	2.15
AF140N4R-3022-11	2.24	AF16Z-22-00-21	2.27	AF26-22-00-14	2.26	AF26N1-30-00-13	2.15
AF140N4R-3022-12	2.24	AF16Z-22-00-22	2.27	AF26-22-00-41	2.26	AF26N1-30-00-14	2.15
AF140N4R-3022-13	2.24	AF16Z-22-00-23	2.27	AF26-30-00-11	2.2	AF26N1-30-00-41	2.15
AF140N4R-3022-14	2.24	AF16Z-30-01-20	2.3	AF26-30-00-12	2.2	AF26N1M-3002-11	2.21
AF140R-30-22-11	2.12	AF16Z-30-01-21	2.3	AF26-30-00-13	2.2	AF26N1M-3002-12	2.21
AF140R-30-22-12	2.12	AF16Z-30-01-22	2.3	AF26-30-00-14	2.2	AF26N1M-3002-13	2.21
AF140R-30-22-13	2.12	AF16Z-30-01-23	2.3	AF26-30-00-41	2.2	AF26N1M-3002-14	2.21
AF140R-30-22-14	2.12	AF16Z-30-10-20	2.3	AF26-40-00-11	2.26	AF26N1M-3002-41	2.21
AF146-30-11-11	2.5	AF16Z-30-10-21	2.3	AF26-40-00-12	2.26	AF26N1M-3022-11	2.21
AF146-30-11-12	2.5	AF16Z-30-10-22	2.3	AF26-40-00-13	2.26	AF26N1M-3022-12	2.21
AF146-30-11-13	2.5	AF16Z-30-10-23	2.3	AF26-40-00-14	2.26	AF26N1M-3022-13	2.21
AF146-30-11-14	2.5	AF16Z-40-00-20	2.27	AF26-40-00-41	2.26	AF26N1M-3022-14	2.21
AF146-30-11B-11	2.5	AF16Z-40-00-21	2.27	AF2650-30-11-70	2.8	AF26N1M-3022-41	2.21
AF146-30-11B-12	2.5	AF16Z-40-00-22	2.27	AF265-30-11-11	2.6	AF26N1R-3002-11	2.21
AF146-30-11B-13	2.5	AF16Z-40-00-23	2.27	AF265-30-11-12	2.6	AF26N1R-3002-12	2.21
AF146-30-11B-14	2.5	AF16ZM-30-22-21	2.10	AF265-30-11-13	2.6	AF26N1R-3002-13	2.21
AF16-22-00-11	2.26	AF16ZM-30-22-22	2.10	AF265-30-11-14	2.6	AF26N1R-3002-14	2.21
AF16-22-00-12	2.26	AF16ZM-30-22-23	2.10	AF265M-30-22-11	2.13	AF26N1R-3002-41	2.21
AF16-22-00-13	2.26	AF16ZR-30-22-21	2.10	AF265M-30-22-12	2.13	AF26N1R-3022-11	2.21
AF16-22-00-14	2.26	AF16ZR-30-22-22	2.10	AF265M-30-22-13	2.13	AF26N1R-3022-12	2.21
AF16-22-00-41	2.26	AF16ZR-30-22-23	2.10	AF265M-30-22-14	2.13	AF26N1R-3022-13	2.21
AF16-30-01-11	2.2	AF190-30-11-11	2.6	AF265N5-30-11-11	2.18	AF26N1R-3022-14	2.21
AF16-30-01-12	2.2	AF190-30-11-12	2.6	AF265N5-30-11-12	2.18	AF26N1R-3022-41	2.21
AF16-30-01-13	2.2	AF190-30-11-13	2.6	AF265N5-30-11-13	2.18	AF26N1Z-30-00-20	2.16
AF16-30-01-14	2.2	AF190-30-11-14	2.6	AF265N5-30-11-14	2.18	AF26N1Z-30-00-21	2.16
AF16-30-01-41	2.2	AF190M-30-22-11	2.13	AF265N5M-3022-11	2.24	AF26N1Z-30-00-22	2.16
AF16-30-10-11	2.2	AF190M-30-22-12	2.13	AF265N5M-3022-12	2.24	AF26N1Z-30-00-23	2.16
AF16-30-10-12	2.2	AF190M-30-22-13	2.13	AF265N5M-3022-13	2.24	AF26N1ZM-3002-21	2.22
AF16-30-10-13	2.2	AF190M-30-22-14	2.13	AF265N5M-3022-14	2.24	AF26N1ZM-3002-22	2.22
AF16-30-10-14	2.2	AF190R-30-22-11	2.13	AF265N5R-3022-11	2.24	AF26N1ZM-3002-23	2.22
AF16-30-10-41	2.2	AF190R-30-22-12	2.13	AF265N5R-3022-12	2.24	AF26N1ZM-3022-21	2.22
AF16-40-00-11	2.26	AF190R-30-22-13	2.13	AF265N5R-3022-13	2.24	AF26N1ZM-3022-22	2.22
AF16-40-00-12	2.26	AF190R-30-22-14	2.13	AF265N5R-3022-14	2.24	AF26N1ZM-3022-23	2.22
AF16-40-00-13	2.26	AF2050-30-11-70	2.8	AF265R-30-22-11	2.13	AF26N1ZR-3002-21	2.22
AF16-40-00-14	2.26	AF205-30-11-11	2.6	AF265R-30-22-12	2.13	AF26N1ZR-3002-22	2.22
AF16-40-00-41	2.26	AF205-30-11-12	2.6	AF265R-30-22-13	2.13	AF26N1ZR-3002-23	2.22
AF1650-30-11-70	2.8	AF205-30-11-13	2.6	AF265R-30-22-14	2.13	AF26N1ZR-3022-21	2.22
AF1650N83011-70	2.20	AF205-30-11-14	2.6	AF26M-30-02-11	2.9	AF26N1ZR-3022-22	2.22
AF16M-30-22-11	2.9	AF205M-30-22-11	2.13	AF26M-30-02-12	2.9	AF26N1ZR-3022-23	2.22
AF16M-30-22-12	2.9	AF205M-30-22-12	2.13	AF26M-30-02-13	2.9	AF26R-30-02-11	2.9
AF16M-30-22-13	2.9	AF205M-30-22-13	2.13	AF26M-30-02-14	2.9	AF26R-30-02-12	2.9
AF16M-30-22-14	2.9	AF205M-30-22-14	2.13	AF26M-30-02-41	2.9	AF26R-30-02-13	2.9
AF16M-30-22-41	2.9	AF205R-30-22-11	2.13	AF26M-30-22-11	2.9	AF26R-30-02-14	2.9
AF16R-30-22-11	2.9	AF205R-30-22-12	2.13	AF26M-30-22-12	2.9	AF26R-30-02-41	2.9
AF16R-30-22-12	2.9	AF205R-30-22-13	2.13	AF26M-30-22-13	2.9	AF26R-30-22-11	2.9
AF16R-30-22-13	2.9	AF205R-30-22-14	2.13	AF26M-30-22-14	2.9	AF26R-30-22-12	2.9

# Catalog number alphanumeric

Catalog number	Page	Catalog number	Page	Catalog number	Page	Catalog number	Page
AF26R-30-22-13	2.9	AF30M-30-22-11	2.9	AF38-30-00-12	2.2	AF40N2M-3022-12	2.23
AF26R-30-22-14	2.9	AF30M-30-22-12	2.9	AF38-30-00-13	2.2	AF40N2M-3022-13	2.23
AF26R-30-22-41	2.9	AF30M-30-22-13	2.9	AF38-30-00-14	2.2	AF40N2M-3022-14	2.23
AF26Z-22-00-20	2.27	AF30M-30-22-14	2.9	AF38-30-00-41	2.2	AF40N2M-3022-41	2.23
AF26Z-22-00-21	2.27	AF30M-30-22-41	2.9	AF38-40-00-11	2.26	AF40N2R-3022-11	2.23
AF26Z-22-00-22	2.27	AF30R-30-02-11	2.9	AF38-40-00-12	2.26	AF40N2R-3022-12	2.23
AF26Z-22-00-23	2.27	AF30R-30-02-12	2.9	AF38-40-00-13	2.26	AF40N2R-3022-13	2.23
AF26Z-30-00-20	2.3	AF30R-30-02-13	2.9	AF38-40-00-14	2.26	AF40N2R-3022-14	2.23
AF26Z-30-00-21	2.3	AF30R-30-02-14	2.9	AF38-40-00-41	2.26	AF40N2R-3022-41	2.23
AF26Z-30-00-22	2.3	AF30R-30-02-41	2.9	AF38Z-22-00-20	2.27	AF40R-30-22-11	2.11
AF26Z-30-00-23	2.3	AF30R-30-22-11	2.9	AF38Z-22-00-21	2.27	AF40R-30-22-12	2.11
AF26Z-40-00-20	2.27	AF30R-30-22-12	2.9	AF38Z-22-00-22	2.27	AF40R-30-22-13	2.11
AF26Z-40-00-21	2.27	AF30R-30-22-13	2.9	AF38Z-22-00-23	2.27	AF40R-30-22-14	2.11
AF26Z-40-00-22	2.27	AF30R-30-22-14	2.9	AF38Z-30-00-20	2.3	AF40R-30-22-41	2.11
AF26Z-40-00-23	2.27	AF30R-30-22-41	2.9	AF38Z-30-00-21	2.3	AF460-30-11-68	2.7
AF26ZM-30-02-21	2.10	AF30Z-30-00-20	2.3	AF38Z-30-00-22	2.3	AF460-30-11-69	2.7
AF26ZM-30-02-22	2.10	AF30Z-30-00-21	2.3	AF38Z-30-00-23	2.3	AF460-30-11-70	2.7
AF26ZM-30-02-23	2.10	AF30Z-30-00-22	2.3	AF38Z-40-00-20	2.27	AF460-30-11-71	2.7
AF26ZM-30-22-21	2.10	AF30Z-30-00-23	2.3	AF38Z-40-00-21	2.27	AF460M-30-11-68	2.14
AF26ZM-30-22-22	2.10	AF30ZM-30-02-21	2.10	AF38Z-40-00-22	2.27	AF460M-30-11-69	2.14
AF26ZM-30-22-23	2.10	AF30ZM-30-02-22	2.10	AF38Z-40-00-23	2.27	AF460M-30-11-70	2.14
AF26ZR-30-02-21	2.10	AF30ZM-30-02-23	2.10	AF400-30-11-68	2.7	AF460M-30-11-71	2.14
AF26ZR-30-02-22	2.10	AF30ZM-30-22-21	2.10	AF400-30-11-69	2.7	AF460N6-3011-68	2.19
AF26ZR-30-02-23	2.10	AF30ZM-30-22-22	2.10	AF400-30-11-70	2.7	AF460N6-3011-69	2.19
AF26ZR-30-22-21	2.10	AF30ZM-30-22-23	2.10	AF400-30-11-71	2.7	AF460N6-3011-70	2.19
AF26ZR-30-22-22	2.10	AF30ZR-30-02-21	2.10	AF400M-30-11-68	2.14	AF460N6-3011-71	2.19
AF26ZR-30-22-23	2.10	AF30ZR-30-02-22	2.10	AF400M-30-11-69	2.14	AF460N6M-11-68	2.25
AF30-30-00-11	2.2	AF30ZR-30-02-23	2.10	AF400M-30-11-70	2.14	AF460N6M-11-69	2.25
AF30-30-00-12	2.2	AF30ZR-30-22-21	2.10	AF400M-30-11-71	2.14	AF460N6M-11-70	2.25
AF30-30-00-13	2.2	AF30ZR-30-22-22	2.10	AF400R-30-11-68	2.14	AF460N6M-11-71	2.25
AF30-30-00-14	2.2	AF30ZR-30-22-23	2.10	AF400R-30-11-69	2.14	AF460N6R-11-68	2.25
AF30-30-00-41	2.2	AF370-30-11-11	2.6	AF400R-30-11-70	2.14	AF460N6R-11-69	2.25
AF305-30-11-11	2.6	AF370-30-11-12	2.6	AF400R-30-11-71	2.14	AF460N6R-11-70	2.25
AF305-30-11-12	2.6	AF370-30-11-13	2.6	AF40-30-11-11	2.4	AF460N6R-11-71	2.25
AF305-30-11-13	2.6	AF370-30-11-14	2.6	AF40-30-11-12	2.4	AF460R-30-11-68	2.14
AF305-30-11-14	2.6	AF370M-30-22-11	2.13	AF40-30-11-13	2.4	AF460R-30-11-69	2.14
AF305M-30-22-11	2.13	AF370M-30-22-12	2.13	AF40-30-11-14	2.4	AF460R-30-11-70	2.14
AF305M-30-22-12	2.13	AF370M-30-22-13	2.13	AF40-30-11-41	2.4	AF460R-30-11-71	2.14
AF305M-30-22-13	2.13	AF370M-30-22-14	2.13	AF40M-30-22-11	2.11	AF52-30-11-11	2.4
AF305M-30-22-14	2.13	AF370R-30-22-11	2.13	AF40M-30-22-12	2.11	AF52-30-11-12	2.4
AF305R-30-22-11	2.13	AF370R-30-22-12	2.13	AF40M-30-22-13	2.11	AF52-30-11-13	2.4
AF305R-30-22-12	2.13	AF370R-30-22-13	2.13	AF40M-30-22-14	2.11	AF52-30-11-14	2.4
AF305R-30-22-13	2.13	AF370R-30-22-14	2.13	AF40M-30-22-41	2.11	AF52-30-11-41	2.4
AF305R-30-22-14	2.13	AF38-22-00-11	2.26	AF40N2-30-11-11	2.17	AF52M-30-22-11	2.11
AF30M-30-02-11	2.9	AF38-22-00-12	2.26	AF40N2-30-11-12	2.17	AF52M-30-22-12	2.11
AF30M-30-02-12	2.9	AF38-22-00-13	2.26	AF40N2-30-11-13	2.17	AF52M-30-22-13	2.11
AF30M-30-02-13	2.9	AF38-22-00-14	2.26	AF40N2-30-11-14	2.17	AF52M-30-22-14	2.11
AF30M-30-02-14	2.9	AF38-22-00-41	2.26	AF40N2-30-11-41	2.17	AF52M-30-22-41	2.11
AF30M-30-02-41	2.9	AF38-30-00-11	2.2	AF40N2M-3022-11	2.23	AF52R-30-22-11	2.11

# Catalog number alphanumeric

Catalog number	Page	Catalog number	Page	Catalog number	Page	Catalog number	Page
AF52R-30-22-12	2.11	AF750N7R-11-70	2.25	AF96R-30-22-14	2.11	BES750-30	2.54
AF52R-30-22-13	2.11	AF750N7R-11-71	2.25	AF96R-30-22-41	2.11	BEY140-4	2.55
AF52R-30-22-14	2.11	AF750R-30-11-68	2.14	ATK1350/4	2.51	BEY190-4	2.55
AF52R-30-22-41	2.11	AF750R-30-11-69	2.14	ATK1350/4	3.10	BEY205-4	2.55
AF580-30-11-68	2.7	AF750R-30-11-70	2.14	ATK1650/4	2.51	BEY265-4	2.55
AF580-30-11-69	2.7	AF750R-30-11-71	2.14	ATK1650/6	2.51	BEY370-4	2.55
AF580-30-11-70	2.7	AF80-30-11-11	2.4	ATK185	2.51	BEY65-4	2.55
AF580-30-11-71	2.7	AF80-30-11-12	2.4	ATK300	2.51	BEY96-4	2.55
AF580M-30-11-68	2.14	AF80-30-11-13	2.4	ATK300/2	2.51	BP38-4	2.50
AF580M-30-11-69	2.14	AF80-30-11-14	2.4	ATK580/2	2.51	BP65-4	2.50
AF580M-30-11-70	2.14	AF80-30-11-41	2.4	ATK580/2HK	3.10	BP96-4	2.50
AF580M-30-11-71	2.14	AF80M-30-22-11	2.11	ATK750/3	2.51	BX4	2.49
AF580R-30-11-68	2.14	AF80M-30-22-12	2.11	ATK750/3HK	3.10	BX4-CA	2.49
AF580R-30-11-69	2.14	AF80M-30-22-13	2.11	BA4	2.49	CA4-01	2.41
AF580R-30-11-70	2.14	AF80M-30-22-14	2.11	BA5-50	2.49	CA4-01-T	2.41
AF580R-30-11-71	2.14	AF80M-30-22-41	2.11	BB4	2.47	CA4-04E	2.41
AF65-30-11-11	2.4	AF80N3-30-11-11	2.17	BDT4	2.50	CA4-04M	2.41
AF65-30-11-12	2.4	AF80N3-30-11-12	2.17	BEA140/XT2	2.56	CA4-04N	2.41
AF65-30-11-13	2.4	AF80N3-30-11-13	2.17	BEA140/XT4	2.56	CA4-10	2.41
AF65-30-11-14	2.4	AF80N3-30-11-14	2.17	BEA16-4	2.57	CA4-10-T	2.41
AF65-30-11-41	2.4	AF80N3-30-11-41	2.17	BEA205/T4	2.56	CA4-13M	2.41
AF65M-30-22-11	2.11	AF80N3M-3022-11	2.23	BEA205/XT4	2.56	CA4-13N	2.41
AF65M-30-22-12	2.11	AF80N3M-3022-12	2.23	BEA26-4	2.57	CA4-22E	2.41
AF65M-30-22-13	2.11	AF80N3M-3022-13	2.23	BEA370/T5	2.56	CA4-22M	2.41
AF65M-30-22-14	2.11	AF80N3M-3022-14	2.23	BEA38-4	2.57	CA4-22N	2.41
AF65M-30-22-41	2.11	AF80N3M-3022-41	2.23	BEA460H/T4	2.56	CA4-22U	2.41
AF65R-30-22-11	2.11	AF80N3R-3022-11	2.23	BEA750/S6	2.56	CA4-31E	2.41
AF65R-30-22-12	2.11	AF80N3R-3022-12	2.23	BEA750/T5	2.56	CA4-31M	2.41
AF65R-30-22-13	2.11	AF80N3R-3022-13	2.23	BEA750D/S6	2.56	CA4-31N	2.41
AF65R-30-22-14	2.11	AF80N3R-3022-14	2.23	BEA750D/T5	2.56	CA4-31U	2.41
AF65R-30-22-41	2.11	AF80N3R-3022-41	2.23	BED460U	2.55	CA4-40E	2.41
AF750-30-11-68	2.7	AF80R-30-22-11	2.11	BED580U	2.55	CA4-40N	2.41
AF750-30-11-69	2.7	AF80R-30-22-12	2.11	BED750U	2.55	CA4-40U	2.41
AF750-30-11-70	2.7	AF80R-30-22-13	2.11	BEF460/OESA400	2.56	CAL18-11	2.42
AF750-30-11-71	2.7	AF80R-30-22-14	2.11	BEF460H/OESA400	2.56	CAL18-11B	2.42
AF750M-30-11-68	2.14	AF80R-30-22-41	2.11	BEF750/OESA800	2.56	CAL19-11	2.42
AF750M-30-11-69	2.14	AF96-30-11-11	2.4	BEM460-30	2.54	CAL19-11B	2.42
AF750M-30-11-70	2.14	AF96-30-11-12	2.4	BEM750-30	2.54	CAL4-11	2.41
AF750M-30-11-71	2.14	AF96-30-11-13	2.4	BEP140-30	2.54	CAL4-11-T	2.41
AF750N7-3011-68	2.19	AF96-30-11-14	2.4	BEP205-30	2.54	CAT4-11E	2.41
AF750N7-3011-69	2.19	AF96-30-11-41	2.4	BEP370-30	2.54	CAT4-11M	2.41
AF750N7-3011-70	2.19	AF96M-30-22-11	2.11	BER140-4	2.54	CAT4-11U	2.41
AF750N7-3011-71	2.19	AF96M-30-22-12	2.11	BER16-4	2.54	CB5-01	2.45
AF750N7M-11-68	2.25	AF96M-30-22-13	2.11	BER205-4	2.54	CB5-10	2.45
AF750N7M-11-69	2.25	AF96M-30-22-14	2.11	BER370-4	2.54	CC4-01	2.41
AF750N7M-11-70	2.25	AF96M-30-22-41	2.11	BER38-4	2.54	CC4-10	2.41
AF750N7M-11-71	2.25	AF96R-30-22-11	2.11	BER65-4	2.54	CE5-01D0.1	2.43
AF750N7R-11-68	2.25	AF96R-30-22-12	2.11	BER96-4	2.54	CE5-01D2	2.43
AF750N7R-11-69	2.25	AF96R-30-22-13	2.11	BES460-30	2.54	CE5-01W0.1	2.43

# Catalog number alphanumeric

Catalog number	Page	Catalog number	Page	Catalog number	Page	Catalog number	Page
CE5-01W2	2.43	LT200A185	3.6	NF44E-11	2.30	NFZ71E-20	2.31
CE5-10D0.1	2.43	LT200E	3.9	NF44E-12	2.30	NFZ71E-21	2.31
CE5-10D2	2.43	LT205-30C	2.51	NF44E-13	2.30	NFZ71E-22	2.31
CE5-10W0.1	2.43	LT205-30L	2.51	NF44E-14	2.30	NFZ71E-23	2.31
CE5-10W2	2.43	LT205-30Y	2.51	NF44E-41	2.30	NFZ80E-20	2.31
CEL18-01	2.44	LT320E	3.9	NF53E-11	2.30	NFZ80E-21	2.31
CEL18-10	2.44	LT370-30C	2.51	NF53E-12	2.30	NFZ80E-22	2.31
DB19EF	3.7	LT370-30D	2.51	NF53E-13	2.30	NFZ80E-23	2.31
DB200	3.6	LT370-30L	2.51	NF53E-14	2.30	PN460-11	2.58
DB42	3.2	LT370-30Y	2.51	NF53E-41	2.30	PN460-21	2.58
DT500/AF460L	3.10	LT460-AC	2.51	NF62E-11	2.30	PN460-41	2.58
DT500/AF460S	3.10	LT460-AL	2.51	NF62E-12	2.30	PN750-11	2.58
DT800/AF750L	3.10	LT500E	3.10	NF62E-13	2.30	PN750-21	2.58
DT800/AF750S	3.10	LT750-AC	2.51	NF62E-14	2.30	PN750-41	2.58
E1250DU1250	3.10	LT750-AL	2.51	NF62E-41	2.30	PR146-1	2.59
E500DU500	3.10	LT800-E	3.10	NF71E-11	2.30	PR185-2	2.59
E800DU800	3.10	LW1250	2.52	NF71E-12	2.30	PR210-1	2.59
EF146-150	3.8	LW140	2.52	NF71E-13	2.30	PR300-1	2.59
EF19-0.32	3.7	LW205	2.52	NF71E-14	2.30	PR300-2	2.59
EF19-1.0	3.7	LW370	2.52	NF71E-41	2.30	PR400-2	2.59
EF19-18.9	3.7	LW460	2.52	NF80E-11	2.30	PR460-1	2.59
EF19-2.7	3.7	LW750	2.52	NF80E-12	2.30	PR460-2	2.59
EF19-6.3	3.7	LX140	2.52	NF80E-13	2.30	PR580-2	2.59
EF205-210	3.9	LX205	2.52	NF80E-14	2.30	PR750-1	2.59
EF370-380	3.9	LX370	2.52	NF80E-41	2.30	PR750-2	2.59
EF45-30	3.7	LX460	2.52	NFZ22E-20	2.29	TA200DU110	3.6
EF45-45	3.7	LX750	2.52	NFZ22E-21	2.29	TA200DU135	3.6
EF65-70	3.8	LY140	2.53	NFZ22E-22	2.29	TA200DU150	3.6
EF96-100	3.8	LY16-4	2.53	NFZ22E-23	2.29	TA200DU175	3.6
EHTK210	3.6	LY185	2.53	NFZ31E-20	2.29	TA200DU200	3.6
HTP500-BA4	2.49	LY300	2.53	NFZ31E-21	2.29	TA200DU90	3.6
KPR-101L	3.2	LY38-4	2.53	NFZ31E-22	2.29	TEF4-OFF	2.46
LD146-30	2.52	LY460	2.53	NFZ31E-23	2.29	TEF4-ON	2.46
LDC4	2.49	LY750	2.53	NFZ40E-20	2.29	TF140DU-110	3.5
LE185	2.51	NF22E-11	2.28	NFZ40E-21	2.29	TF140DU-135	3.5
LE300	2.51	NF22E-12	2.28	NFZ40E-22	2.29	TF140DU-142	3.5
LE460	2.51	NF22E-13	2.28	NFZ40E-23	2.29	TF140DU-90	3.5
LE750	2.51	NF22E-14	2.28	NFZ44E-20	2.31	TF42-0.13	3.2
LF16-4	2.53	NF22E-41	2.28	NFZ44E-21	2.31	TF42-0.17	3.2
LF38-4	2.53	NF31E-11	2.28	NFZ44E-22	2.31	TF42-0.23	3.2
LG16-4	2.53	NF31E-12	2.28	NFZ44E-23	2.31	TF42-0.31	3.2
LH38-4	2.53	NF31E-13	2.28	NFZ53E-20	2.31	TF42-0.41	3.2
LP1250	2.53	NF31E-14	2.28	NFZ53E-21	2.31	TF42-0.55	3.2
LP2050	2.53	NF31E-41	2.28	NFZ53E-22	2.31	TF42-0.74	3.2
LP460	2.53	NF40E-11	2.28	NFZ53E-23	2.31	TF42-1.0	3.2
LP460	2.53	NF40E-12	2.28	NFZ62E-20	2.31	TF42-1.3	3.2
LP750	2.53	NF40E-13	2.28	NFZ62E-21	2.31	TF42-1.7	3.2
LP750	2.53	NF40E-14	2.28	NFZ62E-22	2.31	TF42-10	3.2
LT140-30L	2.51	NF40E-41	2.28	NFZ62E-23	2.31	TF42-13	3.2

# Catalog number alphanumeric

Catalog number	Page	Catalog number	Page	Catalog number	Page	Catalog number	Page
TF42-16	3.2	ZAF460-71	2.60				
TF42-2.3	3.2	ZAF750-68	2.60				
TF42-20	3.2	ZAF750-69	2.60				
TF42-24	3.2	ZAF750-70	2.60				
TF42-29	3.2	ZAF750-71	2.60				
TF42-3.1	3.2	ZL1250	2.60				
TF42-35	3.2	ZL1350	2.60				
TF42-38	3.2	ZL1650	2.60				
TF42-4.2	3.2	ZL2050	2.60				
TF42-5.7	3.2	ZL2650	2.60				
TF42-7.6	3.2	ZL400	2.60				
TF65-28	3.3	ZL460	2.60				
TF65-33	3.3	ZL580	2.60				
TF65-40	3.3	ZL750	2.60				
TF65-47	3.3	ZP1650	2.60				
TF65-53	3.3	ZP2650	2.60				
TF65-60	3.3	ZW1650	2.60				
TF65-67	3.3	ZW2650	2.60				
TF96-51	3.4	ZW460	2.60				
TF96-60	3.4	ZW750	2.60				
TF96-68	3.4						
TF96-78	3.4						
TF96-87	3.4						
TF96-96	3.4						
VEM4	2.47						
VM140/190	2.47						
VM1650H	2.47						
VM19	2.47						
VM205/265	2.47						
VM300/460H	2.47						
VM300/460V	2.47						
VM4	2.47						
VM750H	2.47						
VM750V	2.47						
VM96-4	2.47						
WB75A-01	2.48						
WB75A-02	2.48						
WB75A-03	2.48						
WB75A-04	2.48						
WB75A-05	2.48						
WB75A-06	2.48						
WB75A-07	2.48						
WB75A-08	2.48						
XUSP02633	2.49						
ZAF1650-70	2.60						
ZAF2650-70	2.60						
ZAF460-68	2.60						
ZAF460-69	2.60						
ZAF460-70	2.60						



# Contact us

**ABB Inc.**

Low Voltage Products  
16250 W. Glendale Drive  
New Berlin, WI 53151

Technical Support & Customer Service

Phone: 888-385-1221, Option 4

Email: [lvps.support@us.abb.com](mailto:lvps.support@us.abb.com)

Web: [www.abb.us/lowvoltage](http://www.abb.us/lowvoltage)